

Part

K

Holroyd Gardens

Holroyd Development
Control Plan 2013

Contents

1.	Objectives and Approach	453
	1.1. Objectives	453
	1.2. Vision	454
	1.3. Access and Linkages	454
	1.4. Open Spaces	455
	1.5. Built Form	455
	1.6. Streetscape	456
	1.7. Building Envelope	456
	1.8. Adaptable Housing	456
	1.9. Energy efficiency	456
	1.10. Waste management	456
	1.11. Off Street Parking	456
2.	Open Space	457
	2.1. Objectives	457
	2.2. Elements of the Open Space System	458
	2.3. Extension to Walpole Street Park	459
	2.4. Landscaped Spaces	459
	2.5. Pedestrian and Cyclist Facilities	460
	2.6. The Drainage System	461
3.	Streets	462
	3.1. Key Principles	462
	3.2. Street Types and Dimensions	464
	3.3. Road intersections	467
	3.4. Street Landscape	468
4.	Built Form	470
	4.1. Building Envelope and form	470
	4.2. Massing and Fenestration	471
	4.3. Orientation and Solar Access	472
	4.4. Building Appearance	472
	4.5. Specific Precinct Controls	474
	4.6. Development Adjacent to the Heritage Precinct	476
	4.7. Development Adjacent to Walpole Street	477
	4.8. Development Adjacent to the Main Southern Railway & Adjoining Industrial Development	478
	4.9. Site Development Issues	478
5.	Disabled Access and Adaptable Housing	481
6.	Ancillary Issues	482

Holroyd Gardens

Introduction

This Part of Holroyd Development Control Plan 2013 provides a framework that will guide future development in Holroyd Gardens.

The controls and guidelines demonstrate Holroyd City Council's commitment to ensuring redevelopment of the former Goodlet and Smith Brickworks site takes place in a sensitive, sustainable and exemplary manner. Both Council and the joint venture development partner, Delfin Property Group, are committed to ensuring development of the site is of the highest quality.

Land to which this Part applies

This Part of DCP 2013 applies to land known as "Holroyd Gardens", located adjacent to Walpole Street, the Main Southern Railway and Walpole Street Park, Holroyd. The site is defined by the locality plan (Figure I.1 & Figure I.2)

Boundaries for this DCP may be extended in future by the inclusion of additional lands. Where this is the case, the DCP will be amended accordingly.

Relationship to other parts of Holroyd Development Control Plan 2013.

Part K of Holroyd DCP 2013 shall be read in conjunction with the following Parts of Holroyd DCP 2013, which contain Objectives and Development Controls that relate to development in this Part:

- Part A - General Controls
- Part B - Residential Controls
- Part C - Business, Shop Top Housing and Mixed Use Development Controls
- Part E - Public Participation
- Part F - Advertising and Signage Controls
- Part H - Heritage and Conservation Controls
- Part I - Child Care Centre Controls

Definitions

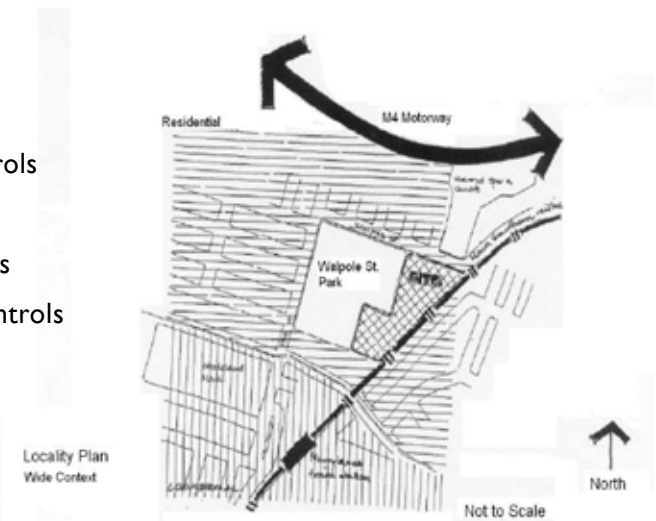
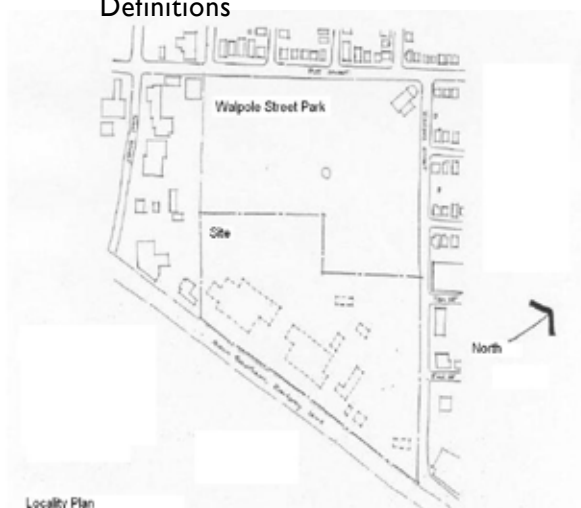

Figure I.1

Figure I.2

Holroyd Gardens

I. Objectives and Approach

I.1. Objectives

- 01.** Redevelopment of the former Goodlet an Smith Brickworks site should:
 - Be responsive to the needs of the community,
 - Achieve high levels of design and appearance,
 - Be responsive to the heritage significance of the site, and
 - Be well integrated with its surrounding urban context.
- 02.** Ensure that the urban structure, layout and form of the development responds positively to its urban context, Specifically:
 - Incorporation and extension of Walpole Street Park into and through the site;
 - Establishing open space links, including pedestrian and bicycle linkages, which connect the site with Walpole Street Park, Merrylands Town Centre and areas further afield.
 - Ensure an appropriate and supportive frontage to Walpole Street and Walpole Street Park
- 03.** Ensure a supportive relationship with the heritage significance of the site. Specifically:
 - Conserve and refurbish significant heritage buildings within an established heritage precinct;
 - Introduce activities within the heritage precinct in order to ensure that the area becomes a “seamless” component of the greater site;
 - Implement specific controls for areas in close proximity to heritage items that ensure new buildings are complementary and not mimicking in terms of form and appearance.
- 04.** Ensure that buildings on the site provide a supportive relationship with the public domain and appropriately respond to the needs of pedestrians.
- 05.** Enable a wide choice of housing types, including adaptable housing, in order to effectively respond the changing need of the community and residential market.
- 06.** Provide a high level of amenity for future residents and users of the site through the provision of a coordinated palette of urban elements including furniture, lighting, paving and vegetation.

Holroyd Gardens

1.2. Vision

Holroyd Gardens is intentionally considered as a garden neighbourhood, with ample open space throughout and the distinctive heritage precinct being actively used as interpretation, open space and community facilities at the heart of the neighbourhood.

A wide linear parkway traverses the length of the neighbourhood and has adjacent to its mid point a large artificial wetland. The site is also directly connected to Walpole Street Park, which extends through to the Heritage Precinct. This combined park system enables all residents to have easy access to a variety of pleasant recreation opportunities.

The main road system and pathway system through the centre of the neighbourhood is intended to give all residents easy access to the Walpole Street Park and the Merrylands Town Centre. The road system and levels of attention to streetscape gives the neighbourhood a distinctive character.

With the exception of the Heritage Precinct, the site will be developed for residential and activities ancillary to such residential development, such as open space and home offices.

Based on the current indicative Master Plan, this DCP envisages that the site will have a maximum density of 260-280 dwellings, comprised of a mix of detached, semi-detached and medium density multi-unit housing. Council may at its discretion consider and approve a variation to the Master Plan where compelling economic, environmental or social grounds are present, and where the overarching objectives and principles of this DCP can be achieved.

1.3. Access and Linkages

Collector Road

A collector road serves to provide a link road through the project. The collector road will have a strong landscape amenity with a regular row of advanced trees and wide verges with wide foot paths/cycleways. The collector road commences at Walpole Street near the Fox Street intersection.

Park Edge Terraces

Park Edge Terraces are positioned along the flanks of the Linear Park and elsewhere. These Terraces have two advantages: They allow access to houses overlooking the reserve; and, they also allow access to the Walpole Street Reserve, allowing the eastern side of the park to be accessible to potential users.

Cycleways and Pedestrian Paths

Cycleways and pedestrian paths are aligned with the open space system as well as streets. These cycleways and pathways link towards:

- Merrylands Town Centre,
- A'Becketts Creek
- Merrylands railway station
- The Heritage Precinct.

Holroyd Gardens

1.4. Open Spaces

Public Open Spaces

The open space system within Holroyd Gardens is extensive and provides variety of spaces appropriate for a wide range of activities. These include:

- Linking visually and physically the heritage precinct buildings with the Walpole Street Reserve.
- The formation of a linear parkway that provides visual amenity, recreation areas and pedestrian/cycle linkages.
- The retention and the re-use of several of the former brickworks buildings as a centre piece for community use
- A central open area adjacent to the Heritage Precinct, opens up to the linear parkway and lake, and provides direct visual links with Walpole Street Park.
- Creation of a variety of landscaped spaces throughout the neighbourhood.

Semi Public/Semi Private Open Spaces - Front Gardens

The amenity of the front gardens is important for extending the general quality of Holroyd Gardens landscape system.

The front yard areas of housing are considered as an opportunity to extend the quality of the street landscape into the front areas of the housing. Colourful front area planting is encouraged.

1.5. Built Form

Density and Building Height

01. Housing is placed so that there is a clear transition in building height and bulk from Walpole Street, towards the railway line and from the Heritage Precinct outwards. This enables the gradual change in density from key elements of the open space system, as well as the vehicular and pedestrian approaches to the housing areas.
02. Housing is positioned so that all houses provide direct surveillance of the proposed street and open space systems, with the majority of housing positioned so that it has frontage to reserves and open space. This strategy encourages a high level of community supervision of the open space areas, as well as maximising the benefit of the open space system to the enjoyment of the residents.
03. Housing is grouped in order to provide areas with opportunity for distinct residential character. There are areas of terrace housing for instance forming two “crescents” facing open spaces. Multi- unit housing is placed alongside the Linear Parkway as well as the Collector Road. The longer building forms of the multi- unit dwellings assist in providing a noise buffer alongside the railway corridor.
04. Residential buildings are to complement heritage buildings within and adjacent to the heritage precinct. It is intended that the addition of any new residential buildings will encourage a higher degree of supervision and better use of the heritage precinct. New buildings adjacent to heritage buildings are to complement (though not mimic) the heritage buildings by virtue of their height, scale, bulk, materials and appearance.

Holroyd Gardens

1.6. Streetscape

A high level of attention to streetscape is a key principle to the visual success of the Holroyd Gardens. This applies to the areas immediately fronting the street, as well as those spaces that are visible from the street.

01. The streetscape should be characterised by buildings with individual variety that give interest, while still forming a cohesive sense of neighbourhood.
02. To ensure that each of the individual houses or groups of houses reinforce and add to the tree lined street environment with a high level of private area planting.
03. To ensure consistent frontages, ridge heights and eave heights..
04. To require a variety of materials within an agreed palette of building materials to be used.

1.7. Building Envelope

01. To ensure housing is considered in terms of its relationship to adjoining buildings to encourage the reinforcement of street enclosure and street character.
02. To encourage Verandahs and projecting awnings, “Dutch Gable” roof forms and similar techniques that “break up” the roof shape.
03. To ensure long flat faced walls are avoided. Walls should incorporate bay windows, porches, small verandahs, French windows to give relief and articulation to exterior walling, and provide internal amenity.

1.8. Adaptable Housing

01. To ensure housing addresses, where practicable, the needs of the disabled and the elderly.

1.9. Energy efficiency

01. To ensure housing demonstrates attention to energy efficient design by:
 - Maximising north orientation;
 - The use of wall and ceiling insulation ;
 - Building forms that allow cross ventilation and zoned heating and cooling;
 - The use and sensible placement of thermal mass; and
 - Appropriate landscape placement.

1.10. Waste management

01. To ensure the provision of adequate dedicated spaces for the storage of waste and recycling away from street. Adequate storage is required for all dwellings.

1.11. Off Street Parking

01. To ensure parking complies with Council’s provisions and is to be designed so as to reduce visual impact on the streetscape.
02. To ensure driveways are designed to minimise the area of hard paving to a practicable minimum.

Holroyd Gardens

2. Open Space

2.1. Objectives

01. The open space system is generally as defined in Figure 3.1.
02. Open space on the site will be interpreted as a continuous system, comprised of places (the heritage precinct, landscaped spaces etc) and linkages (linear park corridor, streets etc)
03. All parks are to be highly accessible, as well as framed and defined by the street system.
04. The site is to provide for linkages to the wider open space system, such as the regional bicycle corridor and Walpole Street Park.
05. Streets are important elements of the open space system. They should provide direct links between key open space destinations.

Pedestrian Linkages

06. The pedestrian system is generally as defined in figure 3.1.
07. A Linear Park Corridor, generally corresponding to the alignment of A'Becketts Creek, will allow for a future pedestrian and bicycle linkage between the site, Merrylands and areas to the north. It will also incorporate a segment of the regional bicycle system.
08. A strong pedestrian linkage will be developed between the Heritage precinct, artificial wetland, and will eventually continue on to the rotunda and Children's Museum in Walpole Street Park. This pathway will provide a strong physical and visual link between Walpole Street Park attractions, the heritage precinct and the site generally.
09. Secondary pedestrian linkages will be provided adjacent to Walpole Street park, adjacent to Walpole Street and south west through Walpole Street Park, linking Merrylands to the site.

Landscape

010. A coordinated landscape master plan for the entire site will be developed and implemented.
011. Plant species chosen for the site should be appropriate in terms of meeting the functional requirements of the environment in which they are to be utilised.
012. The Heritage Precinct and link with Walpole Street Park will be enhanced through the use of (complementary) feature planting.
013. Each Precinct and/or each major street type will contain subtle differences in landscape approach in order to accentuate legibility.



Figure 3.1

Holroyd Gardens

2.2. Elements of the Open Space System

The Heritage Precinct

The Heritage Precinct is located generally adjacent to the Main Southern Railway line, in a central location between Walpole Street and the southern boundary of the site. The location and extent of the Heritage Precinct is defined in Figure 3.2.

The Heritage Precinct should be the focus of development on the site. Refer to the Heritage Strategy Report for details.

Linear Park Corridor

The location of the linear park corridor is described on Figure 3.3.

Objectives

- O1. To encourage the relocation of the weir currently located within the existing A'Becketts Creek alignment to a position within the Linear Park Corridor is encouraged. This will be confirmed following detailed hydraulic investigation ensuring the ability to maintain adequate flood capacity

Development Controls

- C1. The Linear Park corridor will be approximately 19 metres in width.
- C2. The Linear Park corridor is to be accessible from both sides and is to incorporate a pedestrian and bicycle path of at least 2.5 metres width
- C3. The Linear Park Corridor is to accommodate a component of the overland flow generated by development on the site and is to incorporate substantial planting and other landscape treatments to accentuate its appearance as a "creek-like" corridor.



Figure 3.2

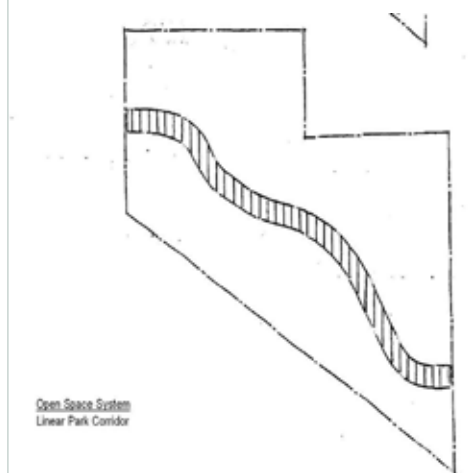

Figure 3.3

Holroyd Gardens

2.3. Extension to Walpole Street Park

Objectives

01. To provide a pedestrian connection to the principal east-west linkage between the Park and Heritage Precinct.
02. To maximise casual surveillance from adjacent residences.
03. To ensure the park extension is well lit.
04. To ensure Walpole Street Park is to be highly accessible.

Development Controls

- C1. Walpole Street Park is to be extended to a new boundary alignment immediately adjacent to residential development on the site (see Figure 3.4)
- C2. The extension area of Walpole Street Park is to incorporate an informal pedestrian path linking Walpole Street to the southern extent of the site.
- C3. Planting in the Walpole Street Park extension area is to be ground covers or clean trunked tree species only.

2.4. Landscaped Spaces

Objectives

01. To ensure high quality landscapes spaces are provided at various locations throughout the site.

Development Controls

- C1. The design of landscape spaces should complement and contribute to the urban setting and add value and amenity to adjacent areas. In addition, they should be designed to:

- Be environmentally sustainable, particularly in their use and demand for water;
- Clearly convey a message that they are available and meant to be used;
- Allow a range of potential activities;
- Be engaging from the outside and within; and
- Foster a safe and secure public domain.

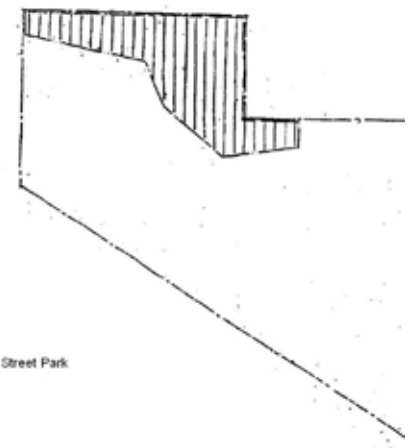

Figure 3.4

Holroyd Gardens

2.5. Pedestrian and Cyclist Facilities

The off-street pedestrian system is comprised of formed paths of either 2.5 metres width for major linkages and pedestrian/bicycle linkages, or 1.5 metres width for secondary (pedestrian only) linkages. These are detailed in Figure 3.1.

Objective

- O1. To ensure all pedestrian and cyclist paths allow high levels of casual surveillance through their location, lighting and form of adjacent planting.

Development Controls

- C1. All footpaths adjacent to streets are to be a minimum of 1.5 metres width.
- C2. Footpaths are to be provided adjacent to streets according to the following schedule:

Collector Road	at least one side
Access Street	at least one side
Access Street serving a maximum of Eight dwellings	none required
Park Edge Terrace	at least one side
Shared Accessway	none required

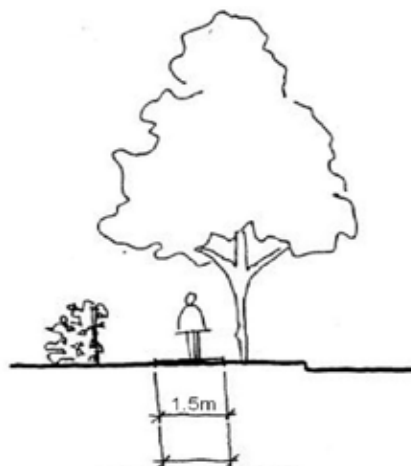

Pedestrian Path
Figure 3.5

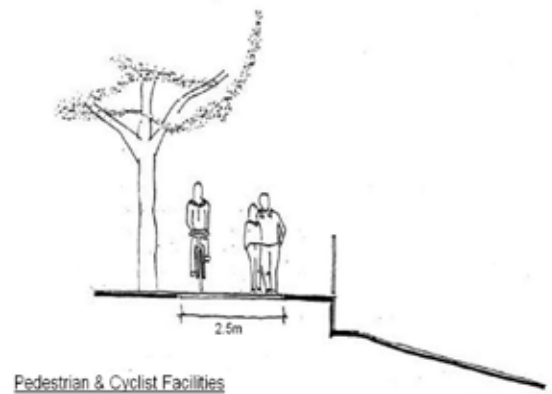

Pedestrian & Cyclist Facilities
Figure 3.6

Holroyd Gardens

2.6. The Drainage System

Objectives

01. To ensure the provision of a combination of underground culverts, the linear park corridor, existing overland flow corridors and the sub-street drainage system will accommodate the ARI 1 in 100 flow.

Development Controls

- C1. An artificial wetland is to be provided adjacent to the Collector Road and Heritage Precinct. The wetland will be a permanent water body, designed to be an important visual amenity for Holroyd Gardens and to treat stormwater pollutants through the use of macrophytes and other such species. The wetland will accommodate a freeboard in order to accommodate on site detention from the western portions of the site.
- C2. An on site detention system is to be designed and constructed to the satisfaction of Council.

Holroyd Gardens

3. Streets

3.1. Key Principles

a) Street System

Objectives

01. To ensure the street system will be the main north south link between Walpole Street and potential future development to the south. It will circulate around the heritage precinct (east) and will be linked by lower order roads at regular intervals along its length.
02. To allow the Walpole Street Park Extension to be utilised for construction of streets, in order to maximise the developable area.

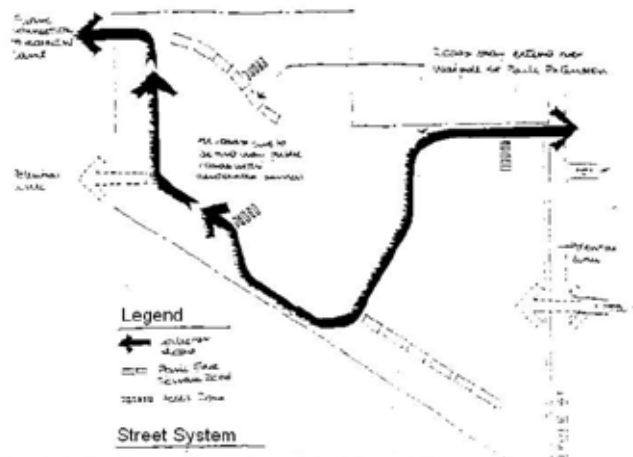

Figure 3.7

Development Control

- C1. To require streets to frame and define key public spaces.
- C2. To ensure the provision for the requirements of emergency and service vehicles are made.

a) Street Character

Objectives

03. To ensure streets are designed such that they are appropriate for all potential users. The design of the street environment should support the establishment of distinct zones of activity, including public space (traffic, parking and pedestrian zones), semi-public space (front yards and porches) and private space (within the building).

Development Controls

- C1. Buildings shall be sited so that they provide strong definition of the public realm. The ratio of building height (at any point) to the horizontal distance between buildings (at a corresponding point), across a street, should generally fall between 1:1.25 and 1:3.7, except in areas adjacent to heritage items. A ratio of up to 1:3.7 will be allowed in cases where smaller buildings are to be located opposite apartment buildings.
- C2. In situations where no other building has been proposed for across the street, the horizontal

Holroyd Gardens

distance between buildings is assumed to be the distance between the proposed building and the maximum building setback (as defined in Clause 4.2) behind the opposite verge/property boundary.

- C3. Streets are to be designed such that there is a clear distinction and progression from private space to semi public, to public space.
- C4. Buildings shall be sited and designed to maximise casual surveillance of the public realm.

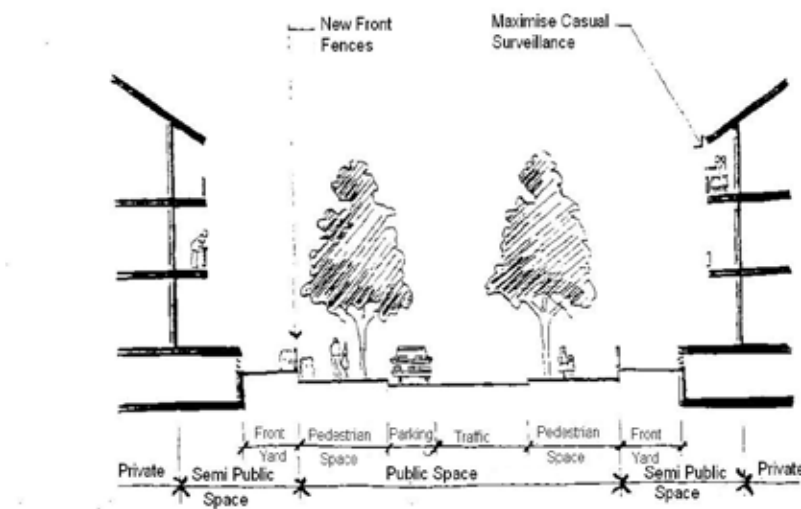

Figure 3.8

Street Character



Figure 3.9

Holroyd Gardens

a) Principal Entrance

The principal entrance to the site will be from Walpole Street, adjacent to the Walpole Street Park boundary.

Objectives

- 04. To allow for a possible second entrance to the site to align with Peel Street.
- 05. To ensure the main entrance is to be designed to provide and coordinate with speed and traffic control on Walpole Street.
- 06. To ensure the main entrance will be designed to reflect its role as a gateway to the site.

3.2. Street Types and Dimensions

a) Collector Road

Objectives

- 01. To provide a principle access for the entire site by connecting with Walpole Street adjacent to Walpole Street Park and circulating east around the heritage precinct.
- 02. To make provisions for future connections with residential development to the south of the site.
- 03. To allow all potential housing types to have frontage to the Collector Road.

Development Controls

- C1. Typical street sections for the collector road are illustrated in Figure 4.4:

Carriageway: 8 metres wide kerb to kerb over its entire length (any variation to be demonstrated to the satisfaction of Council's Engineer).

Verge area: 3.0-3.75 metres (both sides)

Building setback: 4.5 metres maximum to the principal facade

The verge area may be reduced to 1.5 metres on one side where the collector road has development frontage to only one side.

- C2. Council may consider variations to the above dimensions only where overarching principles for Street System, Street Character and Street Landscape (Section 4.1) are achieved.

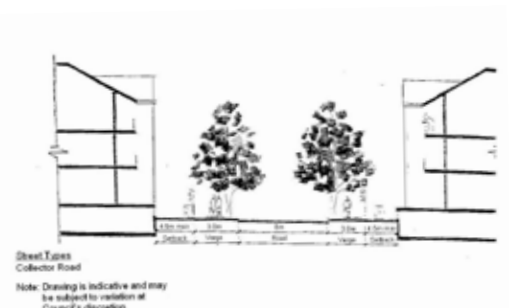

Figure 4.1

Holroyd Gardens

a) Park Edge Terrace

The Park Edge Terrace is a street type which has dwellings located on one side and park frontage on the other.

Objectives

- 04. To increase the level of casual surveillance, thereby enhancing activity, safety and security for park users through the positioning of a road between buildings and the park.
- 05. To allow all potential housing types to have frontage to the Park Edge Terrace.

Development Controls

- C1. A typical street section for the Park Edge Terrace is illustrated in Figure 4.5:

Carriageway:	6.5 – 7.0 metres maximum
Verge area:	3.0-3.75 metres to development side 1.5 metres to the park side

Building setback: 4.5 metres maximum to the principal facade

- C2. Council may consider variations to the above dimensions only where overarching principles for Street System, Street Character and Street Landscape (Section 4.1) are achieved.

a) Access Streets

Objectives

- 06. To provide access streets that connects with the collector road and may be either through routes or cul-de-sacs.

Development Controls

- C1. Typical street sections for Access Streets are illustrated in Figure 4.6:

Carriageway:	6.5-7.0 metres
Verge Area:	3.0-3.75 metres (both sides)

Building Setback: 4.5 metres maximum to the principal facade

- C2. The verge area may be reduced to 1.5 metres on one side where the access street has development frontage to only one side, or where the access street is a cul-de-sac and serves no more than 8 dwellings.
- C3. Council may consider variations to the above dimensions only where overarching principles for Street System, Street Character and Street Landscape (Section 4.1) are achieved.

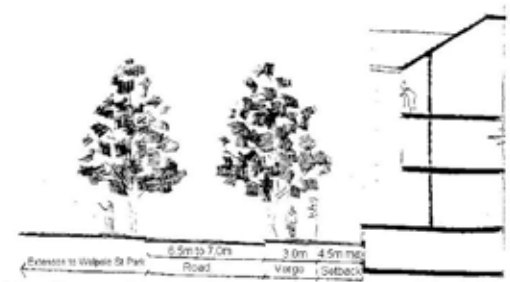

Figure 4.2

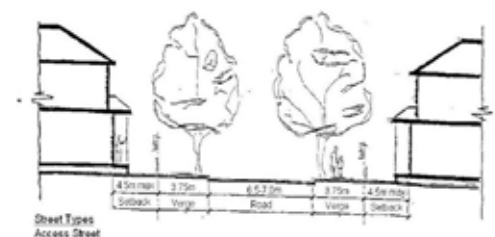

Figure 4.3

Holroyd Gardens

a) Shared Accessway

Objectives

- 07. To allow for shared accessways which may be provided at various locations within Holroyd Gardens and will serve only a limited number of dwellings.
- 08. To ensure the shared accessway will be designed in a manner which provides equal priority for both pedestrians and vehicles.

Development Controls

- C1. A typical street section for the Shared Accessway is illustrated in Figure 4.4. Final dimensions and street design is subject to RMS concurrence:

Carriageway:	5.0-6.5 metres maximum
Verge Area:	none required
Building Setback:	4.5 metres maximum to the principal facade
- C2. Turning areas shall be provided for garbage services and delivery trucks in the form of 8 metre radius turning bulbs or equivalent turning areas within the road reserve at the end points of roads or at a location where garbage trucks can service residences.
- C3. Allowance shall be made for visitors to the Heritage Precinct to turn and exit the site in that vicinity.

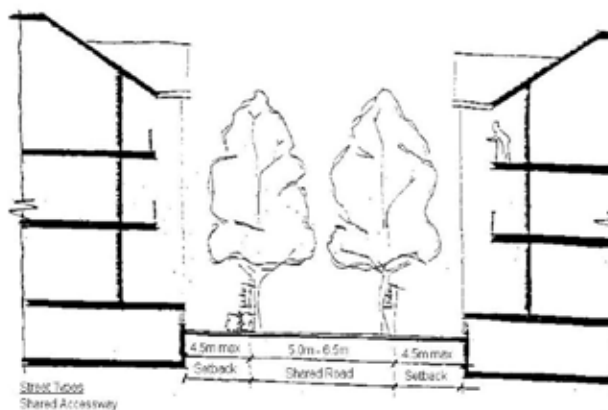

Note: Drawing is indicative and may be subject to change at Council's discretion

Figure 4.4

Holroyd Gardens

3.3. Road intersections

Objectives

- 01. To ensure all road intersections encourage safe vehicle movement.
- 02. To make provisions for efficient and safe pedestrian movement.

Development Controls

- C1. To require minimum curb radius profiles to encourage slower vehicle turns.
- C2. Pram ramps are to be provided for all pedestrian crossing movements.

On Street Parking

Development Controls

- C3. On Street parking will be available on all streets according to the following schedule:

Collector Road	at least one side
Access Street	at least one side
Access Street serving a maximum of Eight dwellings	One side only
Park Edge Terrace	at least one side
Shared Accessway	One side only

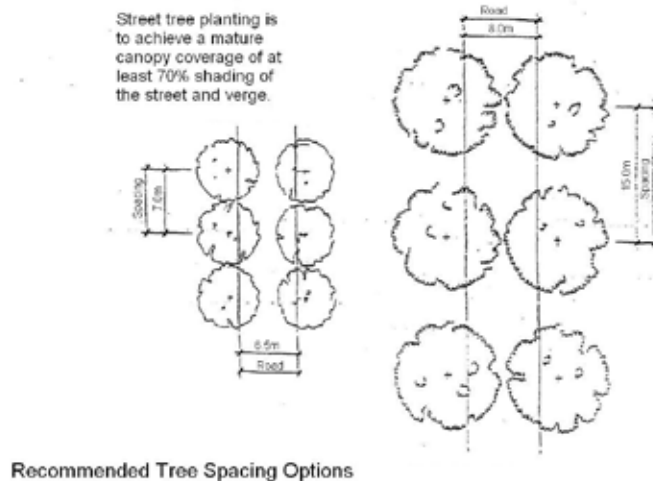

Figure 4.5

Holroyd Gardens

3.4. Street Landscape

a) Street Tree Planting

Objectives

01. To utilise thematic street tree planning to complement the functional role of streets.
02. To ensure that separate species be utilised on separate street types
03. To encourage deciduous street tree planting on all streets.

Development Controls

- C1. Street trees will be planted at a maximum spacing of 15 metres, measured from centre of trunk to centre of trunk.
- C2. At least one street tree shall be planted for each allotment.
- C3. Street Tree species should be selected such that they achieve the following:
 - Super-advanced at planting (at least 200 litre)
 - Possess suitable anti vandal treatment
 - Clean trunked to a height of at least 2 metres.
 - A mature height which is complementary to the scale of the street and the height of predominant buildings which have frontage to that street.
 - A mature canopy diameter of at least 7 metres and which allows for 70% of the street and verge area.

a) Street Furniture

Objectives

04. To ensure there is to be a coordinated palette of street furniture utilised on the site.
05. To ensure the items will be selected to relate strongly to the heritage significance of the site.

Development Controls

- C1. Items Detail of the palette of street furniture selected shall be submitted within a Landscape Master Plan for the site, which will address all elements of the public domain in a coordinated and holistic manner.

a) Lighting

Objectives

06. To provide lighting to improve the level of safety within all streets.
07. To ensure light pole and luminaires shall be of a style, colour and form compatible with the heritage context of the site and the style, colour and form of other urban elements.
08. A strategy for lighting public spaces will be developed in conjunction with Council and will address the full range of issues including light type, appearance and spacing, as well as

Holroyd Gardens

achievement of the relevant standards for acceptable ambient lux levels in public streets and spaces.



Street Landscape
Lighting

Figure 4.6

Development Controls

- C1. Light poles shall be compatible with the pedestrian scale by virtue of their height and relationship to street dimensions.
- C2. Light poles shall be evenly spaced and contribute to establishing a regular pattern and rhythm in the street. Spacing of light poles is to be coordinated with the spacing of street trees.

a) Services

Development Controls

- C3. All services are to be located below ground, both within streets and between streets and individual dwellings.
- C4. All principal services are to be provided in accordance with the requirements of the responsible authority.

Holroyd Gardens

4. Built Form

Objectives

01. Buildings should address and define the public domain, including streets and open space.
02. Buildings may be located up to the surveyed boundary of the Walpole Street Park Extension.
03. Development should form an organised and visually supportive and pleasing appearance to Walpole Street Park and Walpole Street. A high level of casual surveillance is to be afforded by the design of buildings. Service spaces and private open space areas are to be appropriately screened from public view.
04. Setbacks along each street should not be randomly composed. There should be a general consistency of building alignment and the street frontage.
05. Development of the site will be staged, commencing in the area adjacent to Walpole Street.
06. Development of the site shall comprise a mix and variety of housing types throughout.

4.1. Building Envelope and form

With the exception of the Heritage Precinct, the site will be developed for residential and activities ancillary to such residential development, such as open space and home offices.

Based on the current indicative Master Plan, this DCP envisages that the site will have a maximum density of 260-280 dwellings, comprised of a mix of detached, semi-detached and medium density multi-unit housing. Council may at its discretion consider and approve a variation to the Master Plan where compelling economic, environmental or social grounds are present, and where the overarching objectives and principles of this DCP can be achieved.

a) Setbacks

Development Controls

- C1. Buildings must be set back from the property boundary by a distance which supports the achievement of the preferred building height to street width principle. (refer to section 4.1).
- C2. Building setbacks are described on the street sections appearing in Section 3. Specifically these correspond to a maximum of 4.5 metres to the principal facade.

Building Height

- C3. The building height on any street must fall within the range defined by achievement of the preferred building height to street width principle (refer to Section 4.1).
- C4. Building height must conform with the Master Plan approved by Council. A revised Master Plan may be accepted and approved by Council from time to time.

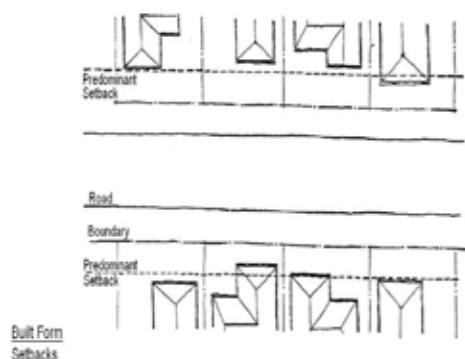

Figure 5.2

Holroyd Gardens

a) Roof Form

Objectives

- 01. To ensure there is a defined palette of roof colours and materials to be utilised throughout the DCP area.
- 02. Habitable use of roof space is encouraged in all residential development. Roof space is not counted as an additional storey for the purposes of this DCP.

Development Controls

- C1. Roofs shall be pitched at a slope which allows their habitable use and which is compatible with the pitch of roofs present on the heritage structures within the Heritage Precinct.
- C2. Roof form features such as hips, gables, chimneys etc. are encouraged in order to give greater visual interest and break up the bulk and mass of the roofscape
- C3. Eaves overhang should be considered in order to provide weather protection to walls.
- C4. Roofs should be of a colour and material which is compatible with important heritage buildings in the locality, and the surrounding urban context. Coloured corrugated steel and Marseilles tiles are encouraged due to their historic association with the site.

4.2. Massing and Fenestration

Objectives

- 01. The massing of buildings on the site should serve to fragment larger building forms into more human scaled components, in both vertical and horizontal planes.
- 02. Building facades are to be articulated and fragmented. They are to utilise building form, the play of light and shade, solid and void, and a variety of materials and elements in order to achieve visual interest and supportive relationship with the scale of pedestrians experiencing the urban environment both inside and outside the site.
- 03. Building facades are to exhibit a clear expression of “base”, “middle” and “top” components.

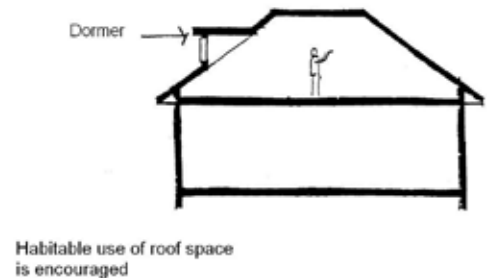

Figure 5.3

Development Controls

- C1. The horizontal bulk of buildings shall be downplayed through the use of strong vertical elements, particularly in cases where long walls will address the street.
- C2. There shall be regular spacing of solid elements and openings within the street facade of buildings.
- C3. Windows shall be vertical in proportion in order to reduce the apparent bulk of buildings.

Holroyd Gardens

4.3. Orientation and Solar Access

Objectives

01. While having regard to the orientation of the site, buildings are to be sited and designed in a manner which minimises their impact in terms of overshadowing.
02. Buildings are to be sited and designed such that a maximum of solar access is gained to internal living spaces and outdoor private open spaces.

Development Controls

- C1. North facing windows to main living spaces should receive a minimum of 4 hours direct sunlight during mid-winter while east and west facing windows should receive a minimum 2 hours direct sunlight during mid-winter. South facing windows in connection with main living areas should be minimised.
- C2. No building should unreasonably overshadow a public space or neighbouring private space between the hours of 10:00 am and 2:00 pm during mid-winter.

4.4. Building Appearance

Objectives

01. The appearance of housing across the site should be coordinated such that there is a reasonable level of individual variety, within the context of achieving a compatible relationship between all buildings. There should be a mix of building forms.
02. Porches and verandahs are encouraged in order to provide shelter, identity, enhance casual surveillance of the street and provide the opportunity for increased community interaction.
03. Front yards are an important aspect for the setting and public appearance of buildings. Front yards should be seen as an opportunity to extend the quality of public landscape into semi-public areas.
04. Front yards should be designed and planted to support the architecture of the building as well as the overall landscape concept for the site.

Development Controls

- C1. All new buildings must consider and respond supportively to buildings located in adjacent positions, as well as across the street. Consistency between ridge, eave and opening heights are important in this respect.
- C2. Building materials and colours selected and utilised on the site are to be coordinated throughout the site and are to be compatible with the heritage structures currently, or formerly, located on the site, and adjoining buildings. Generally, buildings of masonry and/or render construction with light colours of a neutral tone are preferred.
- C3. All housing shall have a clear and visible address point that is directly approached from the street. The front entrance pathway should not be shared with other buildings.
- C4. Entry spaces shall be designed in a manner that restricts direct views into the living spaces of

Holroyd Gardens

dwellings.

- C5.** Landscaping within front yards should enable high levels of casual surveillance of the street to be maintained.
- C6.** Landscape details shall be submitted with each development application.

Holroyd Gardens

4.5. Specific Precinct Controls

Heritage Precinct Transition Area

Building controls for the heritage precinct transition area apply to the area defined on Figure 5.6. Specifically, this area encompasses all land within 25.0 metres inside of the Heritage Precinct's northern, eastern and southern boundaries.

Objectives

- O1. Provide an appropriate visual setting for heritage items;
- O2. Ensure that new development respects the established patterns in the former Goodlet and Smith Brickworks;
- O3. Ensure a harmonious and compatible relationship between the scale of heritage buildings and new development;
- O4. Ensure that new development respects the architectural style and character of the heritage precinct.

Development Controls

Setting

- C1. Care should be taken in the placement of new buildings such that vistas of important heritage buildings are maintained along streets.
- C2. No part of any new development within the heritage precinct should project below the eaves overhang of a heritage item.
- C3. No new building should be located closer than 3.0 metres from a heritage item or its overhang, whichever is the greater.
- C4. New buildings within the heritage precinct should be designed in a manner compatible with the appearance of existing heritage items, without mimicking those heritage items.

Scale

- C5. New buildings located within the heritage precinct should be compatible with existing heritage buildings. They should not visually dominate or compete with the scale of heritage items.
- C6. New development within the heritage precinct should not have more than 2 storeys of habitable space (exclusive of roofspace). Roof pitch and form should reflect that of adjoining heritage items
- C7. No portion of a new building located within the heritage precinct should extend above the ridge height of the Patent Kiln.



Figure 5.5 Each building should have a clearly defined entry. This example utilises both building form and its relationship with the street to clearly define the main entrance.

Figure 5.6

Holroyd Gardens

C8. Simple roof forms, which do not compete with heritage buildings, are appropriate.

Materials

- C9.** While not mimicking existing heritage buildings, new buildings located within the heritage precinct should adopt and utilise external materials and finishes complementary to the heritage fabric. These should be neutral tones
- C10.** Front fences should be either low brick walls or incorporate a plinth, composed of simple rendered and painted brick. Exposed recycled brick is also appropriate.
- C11.** Balconies and verandahs should incorporate only simple railings and balustrades, sympathetic with fencing.
- C12.** Elaborate fretwork is to be avoided.
- C13.** Gutters and flashings are to be of a traditional form. Fascia gutters are to be avoided.
- C14.** New development proposed for the heritage precinct should be reviewed by Council's heritage advisor.

Holroyd Gardens

4.6. Development Adjacent to the Heritage Precinct

Building controls for areas adjacent to the heritage precinct apply to the area defined on Figure 5.7. Specifically, this area encompasses all land outside 25.0 metres of the Heritage Precinct's northern, eastern and southern boundaries.

Objectives

- O1. Provide an appropriate visual setting for heritage items;
- O2. Ensure that new development respects the established patterns in the former Goodlet and Smith Brickworks;
- O3. Ensure a harmonious and compatible relationship between the scale of heritage buildings and new development;
- O4. Ensure that new development respects the architectural style and character of the heritage precinct.

Development Controls

Setting

- C1. New development should be designed and sited in a manner which does not detrimentally effect the heritage significance of either the entire precinct, or individual elements within the precinct.
- C2. New development should be designed in a manner sympathetic to the appearance of existing heritage items.

Scale

- C3. The scale, bulk and height of new buildings located adjacent to the heritage precinct should be visually compatible with, and should not dominate, existing heritage items located within the precinct.
- C4. Any proposed building (or part of a building) located within 20 metres of an identified heritage item should not have more than 2 storeys of habitable space (exclusive of roofspace).
- C5. Roof forms which are sympathetic to those within the heritage precinct are encouraged.

Materials

- C6. While not mimicking existing heritage buildings, new buildings located adjacent to the heritage precinct should adopt and utilise external materials and finishes complementary to the heritage fabric. These should be light colours and neutral tones
- C7. Front fences should be either low brick walls or incorporate a plinth, composed of simple rendered and painted brick.
- C8. Balconies and verandahs should incorporate only simple railings and balustrades, sympathetic with fencing.
- C9. Elaborate fretwork is to be avoided.
- C10. Gutters and flashings are to be of a traditional form. Fascia gutters are to be avoided.

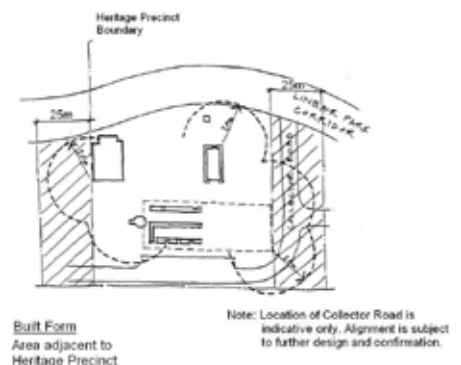

Figure 5.7

Holroyd Gardens

4.7. Development Adjacent to Walpole Street

Objectives

- O1. To ensure buildings experiencing dual frontage to both Walpole Street and streets internal to the site, present a suitable facade to Walpole Street and foster a suitable relationship to the public domain external to the site:
- O2. To provide high levels of casual surveillance to Walpole Street.
- O3. To ensure there is a balance between the requirements of privacy for dwellings and the creation of a suitable interface with Walpole Street:

Development Controls

- C1. Service areas fronting Walpole Street are to be adequately screened such that they are obscured from pedestrian view.
- C2. Building services such as water heaters, rainwater tanks etc may not be located on facades facing Walpole Street.
- C3. Boundary fencing must be coordinated along the length of Walpole Street.
- C4. Boundary fencing may be no higher than 1.8 metres in height.
- C5. Boundary fencing should utilise a variety of materials and/or incorporate substantial articulation and modulation in order to create visual interest. The creation of recessed bays, incorporating planting is encouraged in this respect.
- C6. Buildings with frontage to Walpole Street shall include adequate measures to ameliorate noise impacts generated from both passing traffic and industrial activities located opposite. These measures, and their appropriateness, must be demonstrated through submission of an acoustic assessment.

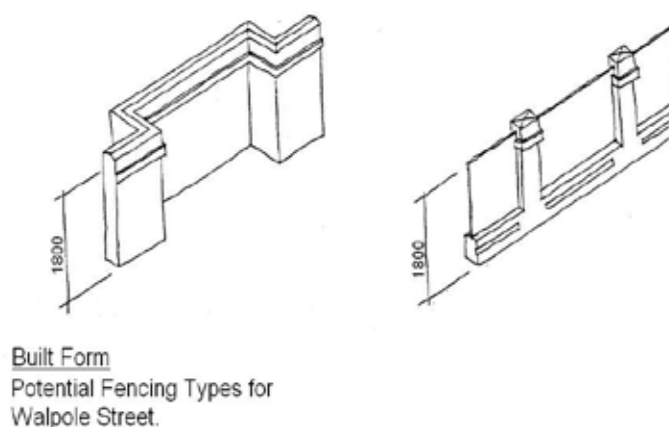

Figure 5.8

Holroyd Gardens

4.8. Development Adjacent to the Main Southern Railway & Adjoining Industrial Development

Objectives

- O1. To ensure buildings located adjacent to the Main Southern Railway present a suitable facade to the railway alignment in order to enhance the visual perception of the site:

Development Controls

- C1. Service areas fronting the railway alignment are to be adequately screened/obscured from view.
- C2. Building services such as water heaters, rainwater tanks etc should not be located on facades facing the railway alignment.
- C3. No building should be located within 3 metres of the railway alignment or the common boundary of adjoining industrial development.
- C4. All buildings located adjacent to the railway alignment and/or adjoining industrial activities must include adequate measures to ameliorate noise impacts generated from the railway and/or industrial activities. These measures, and their appropriateness, must be demonstrated through submission of an acoustic assessment.

4.9. Site Development Issues

a) On Site Open Space

- C1. All dwellings are to be provided with private open space which achieves the following principles:
- Amenity, slope and dimensions suited to the needs of users;
 - Adequate privacy for residents;
 - Access to adequate direct sunlight, particularly during winter months; and
 - Be adjacent and/or visible from the main living areas of dwellings.
- C2. Each dwelling must be provided with a minimum area of private open space consisting of one of the following attributes:
- Ground level area totalling 25m², having a

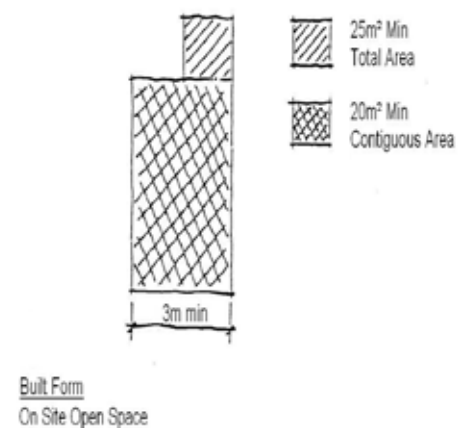

Figure 5.9

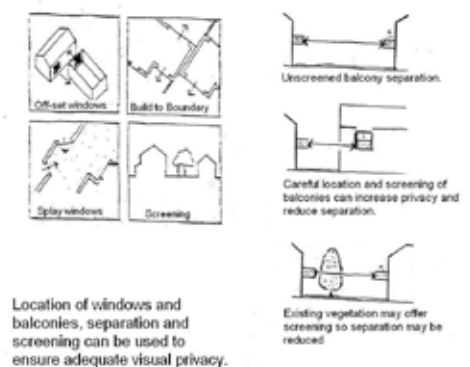

Figure 5.10

Holroyd Gardens

minimum contiguous area of 20m² and a minimum dimension of 3 metres; or

- A balcony, located immediately adjacent to the main living area, with a minimum area of 6m² and a minimum dimension of 1.5 metres (only applicable for blocks of units).

a) Privacy and Overlooking

Visual Privacy

- C3.** Direct overlooking of main internal living areas and private open spaces of adjacent properties should be minimised through building location, the offset-positioning and design of windows, the positioning and design of balconies and/or the use of screening devices where necessary.

Acoustic Privacy

- C4.** Site layout and building design minimises the transmission of external noise to habitable rooms through attention to:
- Siting of buildings
 - Internal room layout
 - Location of private open space
 - Location and design of windows
 - Building construction methods

- C5.** Habitable rooms, particularly bedrooms, shall be separated from significant noise sources

Casual Surveillance

- C6.** Casual surveillance of streets and other public spaces is to be maximised through the following design principles:
- Living areas should be located in areas which directly overlook public spaces.
 - Windows should be located such that they provide for casual surveillance of public spaces.
 - Planting located in semi-public and private areas should be selected such that a generally unobstructed view of public spaces may be available.

a) Access and Parking

- C7.** Parking areas, driveways and street access design are to comply with the relevant Australian Standards. Refer to Part B of Holroyd Development Control Plan.

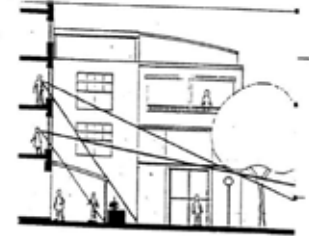

The location of living spaces and position of windows should maximise potential for casual surveillance of streets and public spaces.

Figure 5.11

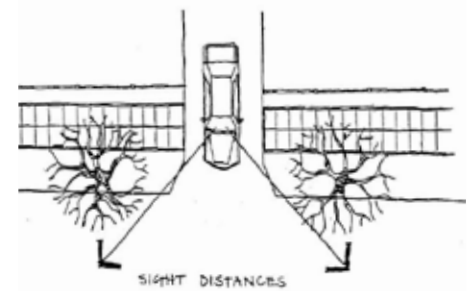

Figure 5.12

Holroyd Gardens

Car Parking

C8. On site car parking for residents is to be provided according to the following:

Apartments	1 space per apartment, dedicated to that apartment; and 1 space per 5 apartments for visitor parking.
Houses, Duplexes & Terracehouses	At least 1 space undercover; and At least one additional space on site

C9.

C10. Bicycle parking is to be provided in multi- unit buildings at a rate of 1 space per 3 apartments.

Driveways

C11. Where paving materials are utilised, these should be:

- In materials, other than plain concrete, and of colours which complement the site.
- The use of colour and materials should be coordinated across the site and be selected from a defined palette for the site.
- Of adequate strength and non-slip qualities.

Access for the Street

C12. Double driveways should be no greater than 5.0 metres in width. Single car driveways should be no greater than 3.0 metres in width.

Flooding and Stormwater Disposal

C13. Habitable floor levels of buildings are to be located at least 300mm above the 1 in 100 year ARI flood level.

C14. Basement level carparks are to incorporate measures such that they are able to remain flood free for the 1 in 100 year ARI flood event

C15. Connection of developments to the street or piped stormwater disposal system

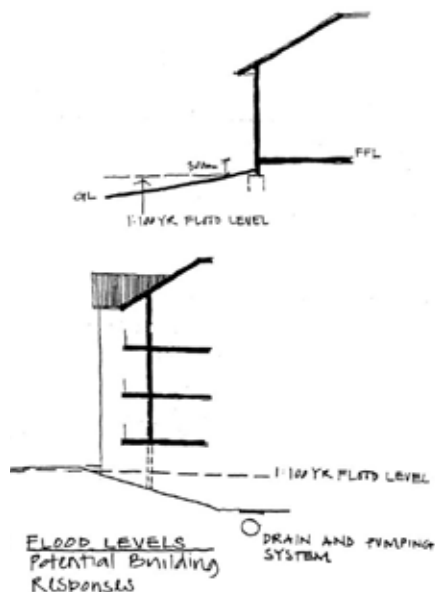

Figure 5.13

5. Disabled Access and Adaptable Housing

The term adaptable housing implies that flexibility is built in at the design stage in order to allow dwellings to be modified when and if, changing circumstances dictate. In this way, adaptable housing achieves principles of robustness in the urban environment. Similarly, adequate provision of disabled access to buildings provides for greater equity and recognises the diversity of potential user groups in the community.

Disabled Access

- C1. Access into or around detached dwellings, townhouses and duplexes is to be flat, or gently sloping. The majority of all ground floor dwellings (detached, terrace houses and duplexes) should be capable of adaptation to allow barrier free access.
- C2. All public spaces should be designed in a manner which allows their equitable use by disabled residents and visitors.

Adaptable Housing

- C3. Development of the site is to achieve the provision of a total of 26 adaptable dwellings, in accordance with AS 4299-Adaptable Housing (Class C), This standard is based on a rate of provision of 1 adaptable unit per 10 dwellings.

Holroyd Gardens

6. Ancillary Issues

a). Energy Efficiency

Objectives

01. To ensure the design and layout of housing on the site facilitates the achievement of appropriate levels of energy efficiency
02. To encourage building design to minimise fossil fuel energy use and to maximise use of natural ventilation, daylight and solar energy.
03. To encourage buildings to utilise layouts that minimise winter heat loss and make use of solar energy for heating wherever possible.
04. To ensure buildings are designed to minimise excessive exposure to summer sun.

Development Controls

- C1. Windows shall be located to facilitate thermal control.
- C2. Building materials should be durable and require low levels of maintenance.
- C3. Materials, which have a higher thermal mass value (e.g. bricks, concrete and stone), shall be utilised where they may benefit thermal control and energy efficiency of a building.
- C4. Buildings are to utilise materials which possess a low level of embodied energy.
- C5. Buildings are to maximise the use of recycled and recyclable materials. In particular, building materials currently located on the site should be reused wherever possible.
- C6. Building fitouts shall utilise energy efficient appliances where available.
- C7. All dwellings are to achieve a minimum 3.5 star rating under the Housing Energy Scheme (NatHERS) Compliance with this requirement is to be demonstrated by the applicant as part of the development application submission.

b). Garbage Disposal and Waste Storage

- C1. Appropriate space shall be provided within each dwelling for the temporary storage of garbage and recyclables.
- C2. A waste storage area is provided on site, is accessible to users and is of a size that caters for the following requirements:

	Height	Width	Depth
120 litre bin	930 mm	480 mm	550 mm
240 litre bin	1080 mm	575 mm	730 mm
1100 litre bin	1465 mm	1360 mm	1220 mm

Holroyd Gardens

Dwelling Type	Provision
Detached House	1 x 240 litre garbage bin. 1 x 240 litre split recycling Bin
Villa or Townhouse	1 x 120 litre garbage bin. 1 x 240 litre split recycling Bin
Apartments	1 x 1100 litre container per 8 units
Apartments (not exceeding 10 units)	1 x 240 litre split recycling bin
Apartments (greater than 10 units)	1 x 240 litre paper recycling bin per 6 units 1 x 240 litre comingled bin per 6 units

- C3. The location and design of waste storage facilities is complementary to the architecture, landscape and street frontage of the development.

c). **Boundary Fencing**

Objectives

- O1. To utilise fencing to enhance an image/perception of quality and provide appropriate levels of privacy.
- O2. To utilise front fences to provide a suitable transition between the public domain and semi-public areas located within individual allotments.
- O3. To discourage high front fences which are not transparent

Development Controls

- C1. Detached, Terrace houses Duplexes
- The option of no front fence is encouraged.
 - Front fences must not exceed 1.5 metres from ground level (excluding piers).
 - Front fences must be highly transparent
- C2. Apartment Buildings
- Front fences are required for all buildings in order to provide an appropriate transition between public and semi-public space.
 - Front fences must not exceed 1.8 metres (excluding piers)
 - Front fences must be highly transparent.
- C3. Side and rear fencing should be generally no higher than 1.8 metres. They should provide an adequate level of privacy to private open spaces and should be consistent with building design and where visible from the street.

d). **Street Numbers**

- C1. All street numbers must be clearly visible from the principal street frontage.

Holroyd Gardens

e). Garages and Outbuildings

- C1. Garages and outbuildings are to comply with all other relevant sections of this DCP, Specifically, Building Envelope, Building Form, Building Appearance and Specific Precinct Controls where applicable.
- C2. Garages and outbuildings should be designed to complement the architecture of the main building to which they are related.
- C3. All garages and carports must be set back behind the main front facade of the building to which they are related.

f). Clothes Drying Areas

- C1. Clothes drying areas are to be screened from both the street and adjoining properties.
- C2. Clothes drying areas are to be easily accessible from dwellings and should not dominate the form and availability of private open space within a development.

g). Storage Areas

- C1. Adequate storage space is to be provided for all residential development and may be provided either within a dwelling or within common areas such as parking garages.

h). Telecommunications Facilities

- C1. Telecommunications facilities are to be located such that they do not detract from the



Figure 7.1 Appropriate boundary fencing for detached dwellings

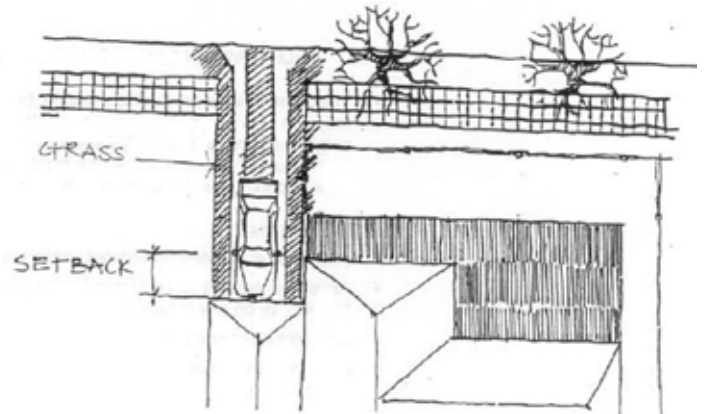

Fig. 7.3 GARAGE SETBACK

Figure 7.3



Figures 7.1 & 7.2

Figure 7.2 Appropriate boundary fencing and landscape for apartment buildings

Holroyd Gardens

aesthetic appeal of the neighbourhood or adversely impact on the visual amenity of neighbours.

C2. Telecommunications services are to be located underground (see also section 4.6).

i). Antennae

C1. Antennae are preferably located within the roof cavity.

C2. Antennae are not to be located on the front facade of any building, or on any facade facing Walpole Street.

C3. A maximum of one antenna is permitted per building.

C4. Antennae must not extend above the uppermost ridge line of a building.

j). Cabling

C1. All cabling, for the purposes of pay TV etc, must be located below ground.

k). Satellite Dishes

C1. No satellite dish is to be located on the front facade of a building, or be visible from a public street.

C2. Satellite dishes are to be located below the ridgeline (or parapet) of the roof.

C3. A maximum of one satellite dish is permitted per building.