

**Part**

---

**F**



CUMBERLAND  
CITY COUNCIL

# **Precinct and Site Specific Development Controls**

This page has been left intentionally blank



CUMBERLAND  
CITY COUNCIL

# **PART F**

# **PRECINCT AND SITE SPECIFIC DEVELOPMENT CONTROLS**

This page has been left intentionally blank.





CUMBERLAND  
CITY COUNCIL

# PART F1 RESIDENTIAL SITE SPECIFIC

This page has been left intentionally blank.

## Part F1 Residential Site-Specific Contents

<b>PART F1-1 1A AND 1B QUEEN STREET, AUBURN</b>	<b>F1-11</b>
1. Introduction	F1- 13
2. Vision and general objectives	F1- 14
3. Specific objectives and controls	
3.1 Connections and access	F1- 15
3.2 Open space	F1- 15
3.3 Building form	F1- 16
3.4 Acoustic amenity	F1- 18
<b>PART F1-2 37 39 PAVESI STREET, SMITHFIELD</b>	<b>F1- 20</b>
1. Introduction	F1- 22
2. Specific objectives and controls	
2.1 Amenity	F1- 23
2.2 Traffic, access and parking	F1- 23
<b>PART F1-3 190-220 DUNMORE STREET, PENDLE HILL (BONDS SPINNING MILL SITE)</b>	<b>F1- 26</b>
1. Introduction	F1- 28
2. Vision and general objectives	F1- 29
3. Specific objectives and controls	
3.1 Land use	F1- 31
3.2 Building height	F1- 32
3.3 Building siting	F1- 33
3.4 Built form	F1- 34
3.5 Open space	F1- 38
3.6 Movement network	F1- 42
3.7 Managing transport demand	F1- 44
3.8 Heritage	F1- 45
<b>PART F1-4 BRADMAN STREET, GREYSTANES (PROPOSED DEVELOPMENT AND SUBDIVISION)</b>	<b>F1- 49</b>
1. Introduction	F1- 51
2. Specific Objectives and Controls	F1- 51

<b>PART F1-5 CROSBY STREET, GREYSTANES</b>	<b>F1- 53</b>
1. Introduction	F1- 55
2. Vision	F1- 55
3. Specific objectives and controls	F1- 55
<b>PART F1-6 FOREST GUM ESTATE</b>	<b>F1- 59</b>
1. Introduction	F1- 61
2. Specific objectives and controls	F1- 61
<b>PART F1-7 FORMER LIDCOMBE HOSPITAL SITE</b>	<b>F1- 64</b>
1. Introduction	F1- 66
2. General objectives	
2.1 Staged development	F1- 67
2.2 Terms Unique to the Part	F1- 67
3. Specific objectives and controls	
3.1 Planning Principles	F1- 69
3.2 Heritage	F1- 73
3.3 Landscaping, public open space and public domain	F1- 75
3.4 Roads and access	F1- 77
3.5 Site planning controls	F1- 84
3.6 Residential development and subdivision controls	F1- 90
3.7 Waste controls	F1- 102
3.8 Parking and loading controls	F1- 102
<b>PART F1-8 GARY STREET, MERRYLANDS</b>	<b>F1- 104</b>
1. Introduction	F1- 106
2. Specific objectives and controls	F1- 106
<b>PART F1-9 GREYSTANES CREEK</b>	<b>F1- 108</b>
1. Introduction	F1- 110
2. Vision and general objectives	F1- 110
3. Specific objectives and controls	
3.1 Setback	F1- 111
3.2 Fences	F1- 111
3.3 Landscaping and site design	F1- 112
3.4 Drainage	F1- 114

3.5	Fire	F1- 115
4.	Appendix A – Greystanes Creek	F1- 115
<b>PART F1-10 GUILDFORD PIPEHEAD PRECINCT</b>		<b>F1- 118</b>
1.	Introduction	F1- 120
2.	Vision and general objectives	F1- 121
3.	Specific Objectives and Controls	
3.1	Urban Design	F1- 122
3.2	Lot Structure	F1- 123
3.3	Built form	F1- 124
3.4	Landscape and Open Space	F1- 126
3.5	Transport and Access	F1- 129
3.6	Heritage	F1- 130
<b>PART F1-11 HEREFORD PLACE, WENTWORTHVILLE</b>		<b>F1- 134</b>
1.	Introduction	F1- 136
2.	Vision	F1- 137
3.	Objectives and Controls	F1- 138
<b>PART F1-12 HILLIER STREET, MERRYLANDS</b>		<b>F1- 141</b>
1.	Introduction	F1- 143
2.	Specific objectives and controls	F1- 143
<b>PART F1-13 HOLROYD GARDENS</b>		<b>F1- 146</b>
1.	Introduction	F1- 148
2.	Vision and general objectives	
2.1	Vision and context	F1- 149
2.2	General objectives	F1- 149
2.3	Access and linkages	F1- 150
2.4	Open spaces	F1- 150
2.5	Built form	F1- 151
2.6	Streetscape	F1- 151
2.7	Building envelope	F1- 151
2.8	Adaptable housing	F1- 152
2.9	Energy efficiency	F1- 152
2.10	Waste management	F1- 152
2.11	Off street parking	F1- 152

3.	Specific objectives and controls	
3.1	Open space	F1- 152
3.2	Streets	F1- 158
3.3	Built form	F1- 167
3.4	Disabled access and adaptable housing	F1- 180
3.5	Ancillary issues	F1- 181

**PART F1-14 PEMULWUY RESIDENTIAL F1- 186**

1.	Introduction	F1- 188
2.	Vision and General Objectives	F1- 189
3.	Specific objectives and controls	
3.1	Public open space	F1- 190
3.2	Subdivision	F1- 214
3.3	Building and Siting Requirements for Residential Development	F1- 223
3.4	Subprecinct Controls – Pemulwuy North	F1- 263
3.5	Subprecinct Controls - Pemulwuy South	F1- 267
3.6	Transport Plan	F1- 272
3.7	Heritage	F1- 295
3.8	Biodiversity	F1- 301
3.9	Stormwater and Flooding Management	F1- 310
3.10	Environmental Management	F1- 322

**F1-15 RAAF STORES DEPOT F1- 334**

1.	Introduction	F1- 336
2.	General objectives	F1- 337
3.	Specific objectives and controls	
3.1	Residential density and dwelling mix	F1- 337
3.2	Car parking	F1- 337
3.3	Noise	F1- 337
3.4	Adaptable housing	F1- 337
3.5	Stormwater management	F1- 337
3.6	Tree preservation	F1- 337
3.7	Public domain	F1- 337

<b>PART F1-16 SHERWOOD SCRUBS AND ADJOINING LAND</b>	<b>F1- 339</b>
1. Introduction	F1- 341
2. Specific Objectives and Controls	F1- 341
3. Appendix A	F1- 343
<b>PART F1-17 45 BARCOM STREET, MERRYLANDS WEST</b>	<b>F1- 345</b>
1. Introduction	F1- 346
2. Vision and General Objectives	F1- 347
3. Specific objectives and controls	
3.1 Land Use	F1- 350
3.2 Building height	F1- 352
3.3 Building siting and setbacks	F1- 353
3.4 Built form	F1- 356
3.5 Open space and landscaping	F1- 358
3.6 Movement network	F1- 361
3.7 Managing transport demand and parking	F1- 365
3.8 Environmental Performance	F1- 366
<b>PART F1-18 FRESH HOPE CARE, DUNMORE STREET, PENDLE HILL</b>	<b>F1- 370</b>
1. Introduction	F1- 371
1.1 Land is to which this section applies	F1- 371
2. Vision and general objections	F1- 372
2.1 Vision	F1- 372
2.2 General objectives	F1- 372
2.3 Indicative Master plan	F1- 373
3. Specific objects and controls	F1- 374
3.1 Land use	F1- 374
3.2 Building height	F1- 374
3.3 Building siting and setbacks	F1- 375
3.4 Built form and building design	F1- 378
3.5 Solar access and overshadowing	F1- 379
3.6 Open space and landscaping	F1- 379
3.7 Movement network	F1- 381
3.8 Managing transport demand	F1- 383
3.9 Heritage	F1- 383
<b>PART F1-19 80 BETTY CUTHBERT DRIVE, LIDCOMBE</b>	<b>F1- 388</b>
1. Introduction	

1.1	Purpose of this DCP	F1- 389
1.2	Land to which this Part applies	F1- 389
1.3	Relationship to Cumberland Development Control Plan 2021	F1- 389
2.	Vision and general objections	F1- 390
2.1	Vision	F1- 390
2.2	General objectives	F1- 390
2.3	Indicative Master Plan	F1- 390
3.	Specific objectives and controls	F1- 392
3.1	Land use	F1- 392
3.2	Movement network and street layout	F1- 393
3.3	Pedestrian and cycle circulation	F1- 393
3.4	Parking	F1- 394
3.5	Landscape and public domain	F1- 397
3.6	Proposed school	F1- 405
4.	General Residential Controls	F1- 407
4.1	Site Planning Controls	F1- 407
4.2	Residential Dwelling Controls	F1- 410
<b>PART F1-20 1 CRESCENT STREET, HOLROYD</b>		<b>F1- 422</b>
1.	Introduction	
1.1	Land to which this Part applies	F1- 424
1.2	Relationship to other parts of Cumberland Development Control Plan 2021	F1- 424
1.3	Purpose of this Part	F1- 424
2.	Vision and desired future character	F1- 425
2.1	Vision	F1- 425
2.2	Desired future character	F1- 425
2.3	Desired future character statement	F1- 425
2.4	Masterplan	F1- 426
2.5	Provision of infrastructure services	F1- 428
3.	Development controls	F1- 428
3.1	Building heights and street wall heights	F1- 428
3.2	Setbacks and building separation	F1- 431
3.3	Building design	F1- 433
3.4	Noise	F1- 433
3.5	Open space	F1- 434
3.6	Landscaping and trees	F1- 435
3.7	Vehicular access and movement	F1- 436
3.8	Connectivity	F1- 437
3.9	Parking and basement access	F1- 438
3.10	Site contamination and remediation	F1- 440
3.11	A'Becketts Creek drainage channel	F1- 440
3.12	Railway Memorial	F1- 440



This page has been left intentionally blank.



CUMBERLAND  
CITY COUNCIL

# **PART F1-1**

## **1A AND 1B QUEEN STREET, AUBURN**

This page has been left intentionally blank.

# 1. Introduction

## 1.1 Land to which this Part applies

This Part applies to land zoned R4 High Density Residential known as 1A and 1B Queen Street (Queen Street Site). The site is outlined in red in Figure 1 below.



Figure 1: Area to which this Part applies

## 1.2 Purpose of this Part

The purpose of this part is to provide provisions to guide redevelopment of the site for residential purposes.

In the case of any inconsistency between the controls in other parts of the DCP and the controls in this Part, the controls in this part prevail to the extent of the inconsistency.

## 2. Vision and general objectives

### 2.1 Vision

The vision for the Queen Street site is to create a high quality residential development that has a scale and form that is compatible with surrounding land uses and takes advantage of the site's proximity to existing facilities, services and public transport infrastructure.

### 2.2 Objectives

#### General

- O1. Provide new housing opportunities within walking distance of the town centre, rail station and other public transport opportunities.
- O2. Ensure development is of a scale and character that is consistent with that planned for the neighbouring locality.
- O3. Ensure that a range of housing types are provided across the site.
- O4. Provide an overall built form that is varied and visually interesting.
- O5. Be of a scale that provides logical transitions to the planned future scale of development in the area surrounding the site, particularly to the town centre, adjoining residential zones and the rail corridor.
- O6. Provide visual interest through building articulation, variation in building form, building material palettes/textures when viewed from all external locations including the rail line.
- O7. Incorporate building envelopes which are compatible with the scale of existing and future neighbouring development.
- O8. Provide sufficient communal open space to satisfy the needs of residents.

### 3. Specific objectives and controls

#### 3.1 Connections and access

##### Objective

- O1. Improve the site's connections to Auburn railway station by extending and improving pedestrian and cycle connections within the site.

##### Controls

- C1. Provision for access and through site links should be generally consistent with the strategy shown in Figure 2.
- C2. The Queen Street frontage is to complement surrounding existing and proposed development.
- C3. In providing vehicular access, preference is to be given to Queen Street and to ensuring sufficient space for truck movements.
- C4. Provide through site connectivity including pedestrian and cycle access through the public open space of the development.

#### 3.2 Open space

##### Objectives

- O1. Provide high quality public spaces that make a positive contribution to the visual quality of the development.
- O2. Provide communal spaces that allow opportunities for amenity, outlook and visual separation for residents.
- O3. Maximise the size of public open space areas to enhance useability and flexibility of the space.

##### Controls

- C1. Open space provisions for the development should be generally consistent with the strategy shown in Figure 2.
- C2. Public open space of at least 300 square metres in total, accessible to the public and legible from Queen Street, Louisa Street and/or Marion Street frontages is to be provided.
- C3. The public open space should be focussed in one or two large, useable open spaces.
- C4. Development should allow for the creation of open space areas that provide sufficient separation between buildings to enable appropriate levels of visual and acoustic privacy to be achieved and act as shared landscaped areas for use by residents.
- C5. Open spaces should be well designed areas that include:
  - a space that is legible as public space, rather than a space only for the use of residents,
  - both soft and hard surfaces, (and therefore cannot all be considered deep soil),
  - seating (formal and informal) for individual and group use,
  - trees and other landscaping,

- ideally provision for suitable recreation activities in a space designed for flexible use,
  - public art in the main space.
- C6. Communal open space and deep soil zones are to comply with the relevant provisions of SEPP No 65-Design Quality of Residential Apartment Development and the Apartment Design Guide.
- C7. Deep soil planting areas should enhance site amenity and the streetscape along the rail corridor and all adjoining streets.
- C8. The provision of communal space on roof top levels is supported.
- C9. The associated owners' corporation will own and maintain public and communal open space and associated infrastructure servicing the proposed development.



Source: AJ&C, September 2016 (as amended by Council July 2017)

Figure 2: Access and open space strategy.

### 3.3 Building form

#### Objectives

- O1. Encourage buildings with a scale and form that is compatible with those planned in neighbouring areas.
- O2. Provide a transition in height and density from the site to surrounding residential areas, the railway line and the town centre.
- O3. Ensure that built form defines and activates the site's open spaces and complements the surrounding land use context.
- O4. Building forms should address street frontages along Marion Street and Queen Street and corner buildings shall address both streets.

### Controls

- C1. Development within the site should be generally consistent with the built form strategy shown in Figure 3.
- C2. Buildings are to reinforce the edges of public spaces and connections on the site.
- C3. Development is to include a variety of residential dwelling types.
- C4. Ground floor dwellings are to have direct street address where fronting a public street edge.

### Building envelopes

- C5. Lower scale housing forms such as townhouses / terraces are to be provided along Queen Street to provide an active address to this street and a scale that responds to neighbouring development.
- C6. The following minimum setbacks shall apply to the site:
  - front setback from Queen Street shall be 6m;
  - building setback from the rail corridor shall be 6m;
  - setback from Marion Street shall be 4m; and
  - the setbacks at the corner of Queen and Marion Streets should apply to the final property boundary after any land dedication for the roundabout.

*Note: the setback areas are to be unencumbered by balconies*
- C7. Building separation is to comply with the relevant provisions of SEPP No 65-Design Quality of Residential Apartment Development and the Apartment Design Guide.
- C8. Building heights are shown in metres in the *Cumberland Local Environmental Plan 2021* Height of Buildings Map and site specific clauses are included within *Cumberland Local Environmental Plan 2021*.
- C9. Appropriate building articulation, façade treatment and modulation is to be provided.
  - buildings are to achieve visual interest through variations in massing, articulation and composition of building elements including fenestration, material use, entrances, balconies, balustrades and planters;
  - development is to achieve a varied silhouette when viewed from the rail corridor; and
  - design elements and façade treatments should aim to minimise glare affecting passing pedestrians, vehicles and trains.
- C10. Vertical and horizontal articulation should be substantial, to enable the buildings to be read as separate buildings and should include:
  - vertical recesses;
  - separate façade components with distinct architectural detailing; and
  - DCP enforced building setbacks and height controls.





Source: AJ&C, September 2016

Figure 3: Built form strategy

### 3.4 Acoustic amenity

#### Objective

O1. Achieving occupant amenity by responding appropriately to noise emitters.

#### Controls

C1. An acoustic assessment prepared by a suitably qualified acoustic consultant is to be submitted with any development application for the site. The assessment should address, at minimum:

- impacts on acoustic privacy of proposed residential uses from any surrounding noise sources, such as road and rail traffic and industrial uses;
- the impact of the development on the surrounding area, through mechanical services, earthworks, excavation and construction phases of development; and
- design of buildings shall comply with the internal noise levels in the Clause 102 (3) of the SEPP (Infrastructure) 2007.

This page has been left intentionally blank.



CUMBERLAND  
CITY COUNCIL

# PART F1-2

37-39 PAVESI STREET,  
SMITHFIELD

This page has been left intentionally blank.

# 1. Introduction

## 1.1 Land to which this Part applies

This section applies to land at 37-39 Pavesi Street, Smithfield, being identified as Lot 36 DP 10958, as shown in Figure 1.



Figure 1: Land to which this section applies.

## 2. Specific objectives and controls

### 2.1 Amenity

#### Objectives

- O1. Maximise separation between industrial premises and residential dwellings to ensure amenity for residential dwellings and reduce any potential for conflict between these two land uses.
- O2. Ensure that the adjoining industrial property cannot gain access to the road servicing the residential dwellings.

#### Controls

- C1. The access road is located along the western boundary of the site.
- C2. A minimum 1m landscaped buffer is provided between the cul-de-sac bulb and side property boundary, and between any parking bays and the property boundary (Figure 2).
- C3. A minimum 2.5m landscaped buffer is provided between the road and property boundary in all other locations including the end of the cul-de-sac as shown in Figure 2.
- C4. Access to the new road is only for the purpose of residential development.
- C5. The dwellings at the front should face Pavesi St and all other dwellings must address the new road.

### 2.2 Traffic, access and parking

#### Objectives

- O1. Avoid any impact on the operation of the Pavesi Street traffic control device (slow point).
- O2. Ensure safe movement of all vehicles along the entire length of the access road.
- O3. Enable pedestrian access to all dwellings.

#### Controls

- C1. The access road is located to ensure passenger vehicles can turn left-in/right-out at Pavesi Street without being affected by the slow-point bollards.
- C2. The width and alignment of the access road must enable two service vehicles to pass each other safely at any point along the road (i.e. without crossing the road centre-line).
- C3. A 14m road reserve is provided (Figure 5), incorporating:
  - an 8m carriageway if parking is on-street, or 7m carriageway if parking is in bays; and
  - a 3.5m verge between property boundaries and the street (including the two front dwellings and two rear dwellings).
- C4. The design speed for the access road is 25kph.
- C5. A footpath is provided along the entire length of the access road.

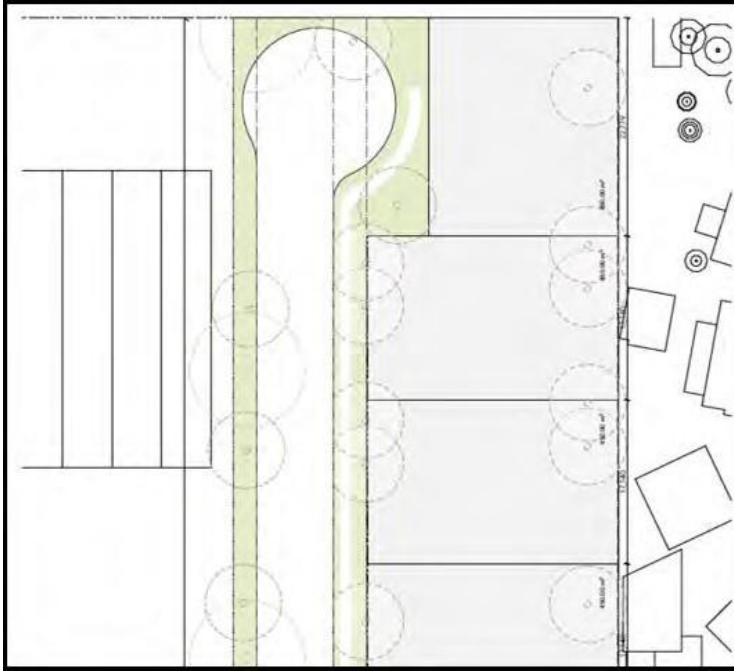

Figure 2: Dimensions of landscaped buffer.



Figure 3: Dimensions of road reserve.

This page has been left intentionally blank.





CUMBERLAND  
CITY COUNCIL

## **PART F1-3**

**190-220 DUNMORE  
STREET, PENDLE HILL  
(BONDS SPINNING MILL  
SITE)**

This page has been left intentionally blank.

# 1. Introduction

## 1.1 Land to which this Part applies

This section applies to land at 190-220 Dunmore Street, Pendle Hill, being identified as Lot 1 DP 735207, as shown in Figure 1.



Figure 1: Land to which this Part applies

## 2. Vision and general objectives

### 2.1 Vision

The Bonds Spinning Mill site is a vibrant, mixed use and compact urban precinct that respects and celebrates its past history and integrates with, complements and enhances the surrounding Pendle Hill community.

### 2.2 General objectives

- O1. Development responds to and respects the site and its context, including its strategic, transit proximate location, topography and surrounding residential uses
- O2. Development is predominantly residential in use, making an important contribution to the amount and choice of housing for the broader community
- O3. Development creates a new heart for the precinct and surrounding Pendle Hill community, including the establishment of non-residential uses that enhance convenience and lifestyle and the provision of a new, publicly accessible, multi-use park and network of public open space
- O4. Existing heritage is retained, restored and adaptively reused to reference the past and provide an asset and focal point for the precinct. New buildings adjacent to existing retained heritage buildings on the site achieve proportional relationships
- O5. Development provides for public access to the precinct and an interconnected, fine-grain and permeable movement network that prioritises pedestrian and cyclist movement
- O6. Development provides for a varied, integrated open space network that provides for a diverse range of informal active and passive recreational activities in a largely green, soft landscaped setting
- O7. Buildings are sited, angled and designed to maximise climatic responsiveness and provide high levels of desirable solar access and natural ventilation
- O8. Development creates a high level of residential amenity, including optimising outlook and views to desirable landscape elements, and respects the amenity of surrounding established residential areas
- O9. Development defines and activates Jones Street, Dunmore Street and new streets
- O10. Development is well designed, with a positive relationship between buildings and adjoining public domain, including providing for high levels of amenity for key public spaces
- O11. Development provides for a high level of engagement between the public and private domains, in particular providing for pedestrian integration and extensive opportunities for passive casual surveillance.

## 2.3 Master plan

The vision and principles for the site as identified above are spatially expressed in the urban structure for the precinct as shown in Figure 2.

To ensure that development provides key elements, where variations to the master plan are proposed, the development application is to demonstrate how the vision and principles have been achieved.



Figure 2: Master Plan



### 3. Specific objectives and controls

#### 3.1 Land use

##### Objectives

- O1. Development creates a high density, vibrant and active urban precinct while ensuring that local movement, community & open space infrastructure is maintained or improved.
- O2. Development provides for centrally located, integrated non-residential uses that support the convenience and lifestyle needs of residents of the precinct and Pendle Hill community.

##### Controls

- C1. Land use is generally in accordance with Figure 3
- C2. Non-residential uses are located generally in accordance with Figure 3.
- C3. Development provides for a maximum of 6,000sqm of GFA of non-residential uses.

*Note: preferred non-residential uses include retail uses (including supermarket, cafes and specialty retail), local services / businesses, medical and community centres.*

- C4. Non-residential uses maximise activation of the multi-use park and public plaza as well as retained heritage buildings.



Figure 3: Land use

## 3.2 Building height

### Objectives

- O1. Building height is varied throughout the precinct to create an articulated and visually interesting skyline, and reinforces the visual prominence of the crest of the hill upon which Dunmore House is located.
- O2. Building height adopts a height pyramid principle with taller buildings located in the centre of the site transitioning to lower rise buildings at the site's edges.
- O3. Building height retains reasonable solar access to neighbouring sites.

### Controls

- C1. Maximum building height is generally in accordance with Figure 4.
- C2. Basement levels are integrated with existing benched ground levels to create new communal landscaped open space.
- C3. Storeys above level 4 are to be set back from the street front by an additional 3m from building line of the storeys below.
- C4. Reduced level details must be in accordance with Part G Cumberland DCP 2021.
- C5. Maximum building height is limited to 4 storeys within the heritage precinct.
- C6. Maximum building height adjacent to the site's boundary with properties in the R2 Low Density Residential zone is 3 storeys.
- C7. Maximum building height fronting a street that separates the site from land in the R2 Low Density Residential zone is 4 – 6 storeys.
- C8. Buildings are setback to allow adequate daylight access to neighbouring properties.



Figure 4: Building height

### 3.3 Building siting

#### Objectives

- O1. Buildings are sited to optimise climatic responsiveness, in particular solar access to ground floor communal open space and public domain.
- O2. Buildings are sited to frame and define streets.
- O3. Buildings are sited to provide a high level of amenity for adjoining and nearby residential uses.
- O4. Buildings are sited to create a physically and visually permeable and open character.

#### Controls

- C1. Buildings are setback a sufficient distance from existing and new streets to provide a balance between activating the street and providing sufficient area for landscaping to soften the visual impact of the built form in the streetscape.
- C2. Building setbacks and separations for buildings fronting internal streets and pocket parks, are generally consistent with Figure 7 - 9.



- C3. Buildings provide a continuous street edge to Jones Street. This does not apply to locations for vehicle access or the location of the park as well as where mature trees that must be retained are present.
- C4. Buildings are setback a minimum of 12m from the site's south-western, southern and eastern boundaries.
- C5. Any possible overlooking to residential areas adjacent is treated with fixed privacy screens, fixed depth planter boxes or similar to maintain adequate privacy to adjoining residential areas.
- C6. Building setbacks and separations for buildings:
  - on the precinct's southern boundary, levels above 4 storeys are generally consistent with Figure 5; and
  - on the precinct's eastern boundary, levels above 4 storeys are generally consistent with Figure 6.
- C7. Buildings adjoining the precinct's southern boundary are separated into distinct, separate buildings and do not create a continuous boundary edge condition.
- C8. Buildings to the Jones Street frontage will have a varying setback that allows ground floor courtyards (no closer than 12m to the Jones Street boundary) with a further setback for the building as well as increased setbacks to retain mature vegetation where relevant.
- C9. Buildings are sited with their long axis aligned north-south to provide north-south views and accessibility throughout the precinct, in particular to the multi-purpose park and heritage buildings.
- C10. Buildings along the southern edge are designed to enable possible future links to the south between main building forms.
- C11. Buildings addressing Dunmore Street have a 4m front setback.

### **3.4 Built form**

#### **Objectives**

- O1. Buildings are designed to activate and engage with the adjoining public domain.
- O2. Buildings are designed to reduce the bulk and scale when viewed from the public domain and provide visual interest.
- O3. Internal street setbacks and upper level setbacks enable sunlight and view corridors, whilst allowing passive surveillance from upper level balconies and terraces.

#### **Controls**

- C1. Buildings are designed to have their main living areas and adjoining private open space oriented to and directly overlook the public domain.
- C2. Building facades are angled to optimise solar access to main internal living areas and adjoining private open space and optimise outlook and views to high amenity features such as open space.

- C3. The Jones Street and Dunmore Street street-walls are broken into a number of smaller parts through significant recesses, other facade modulation or via distinct building elements.
- C4. Building facades feature articulation within a cohesive overall composition using design measures such as:
- recessed and / or projecting balconies;
  - large windows and other openings;
  - sun control devices such as eaves, louvres and screens;
  - privacy screens;
  - blades or fins;
  - elements of a more lightweight material than the main structural framing balustrades to balconies that have a more lightweight appearance than masonry such as glass, metal or timber.
- C5. In relation to residential uses at ground level:
- the number of individual dwelling entries from the adjoining public domain are maximised;
  - where entries provide access to more than one dwelling, they relate to each lift core, are clearly defined and legible and preferably form an architectural feature of the building;
  - pedestrian entries are directly accessible from and at the same level as the adjoining public footpath;
  - main living areas and adjoining private open space are oriented to be parallel and directly overlooking the adjoining public domain;
  - front boundary treatments combine level change, landscaping and fencing to provide a reasonable level of privacy for residents while providing for casual passive surveillance of the adjoining public domain;
  - internal living areas are integrated with areas of outdoor private open space to provide a transition between the public and private domains.
- C6. In relation to non-residential uses at ground level:
- the number of individual tenancies that adjoin and are directly accessible from the public domain are maximised;
  - pedestrian entries are at the same level as the adjoining public domain;
  - large areas of transparent glazing or other openings enable clear sightlines between the public domain and internal areas, in particular those with high levels of activity such as reception, seating and dining areas;
  - cafes or restaurants include outdoor seating in the adjoining public domain;
  - awnings or other overhangs provide shelter for pedestrians;
  - universal access is provided.
- C7. Maximum building depth and width is in accordance with the NSW *Apartment Design Guide* (ADG).
- C8. Building separation is generally consistent with Figures 7 - 9.

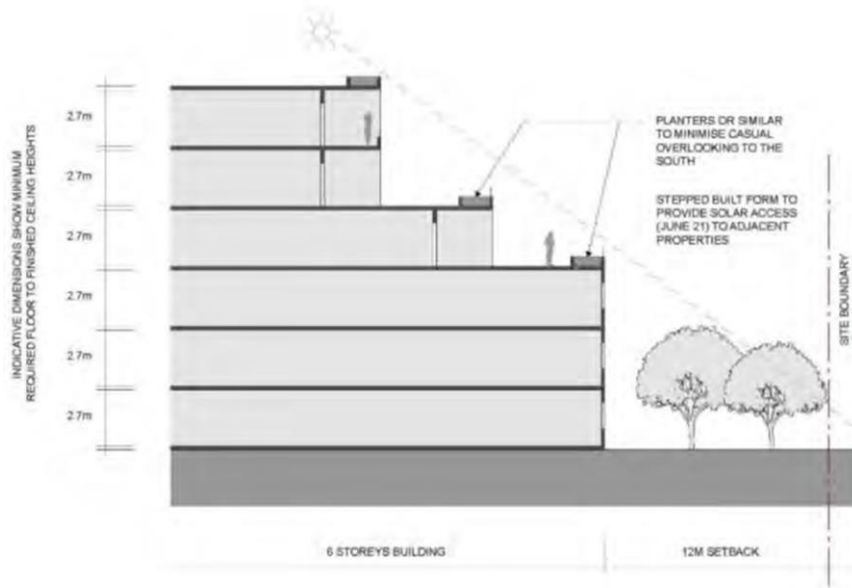

Figure 5: Indicative section at precinct southern boundary, adjoining Jones Street

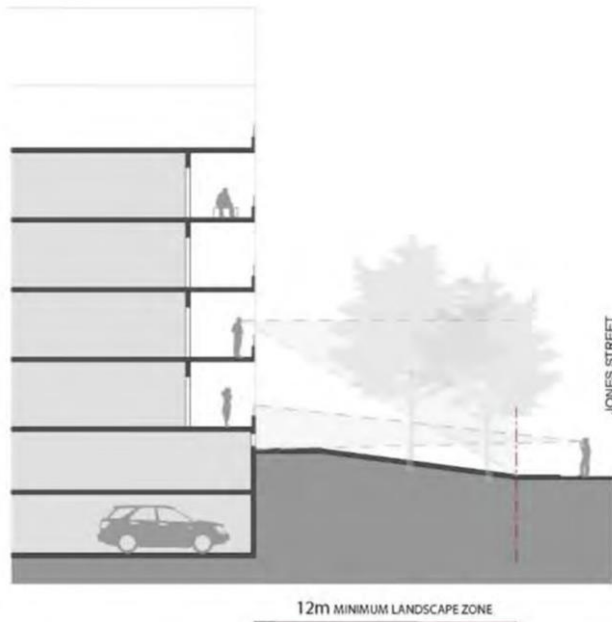

Figure 6: Indicative section at precinct eastern boundary, adjoining Jones Street

Note: Upper level building setbacks are indicative only. Refer to Figure 4 for indicative building heights.

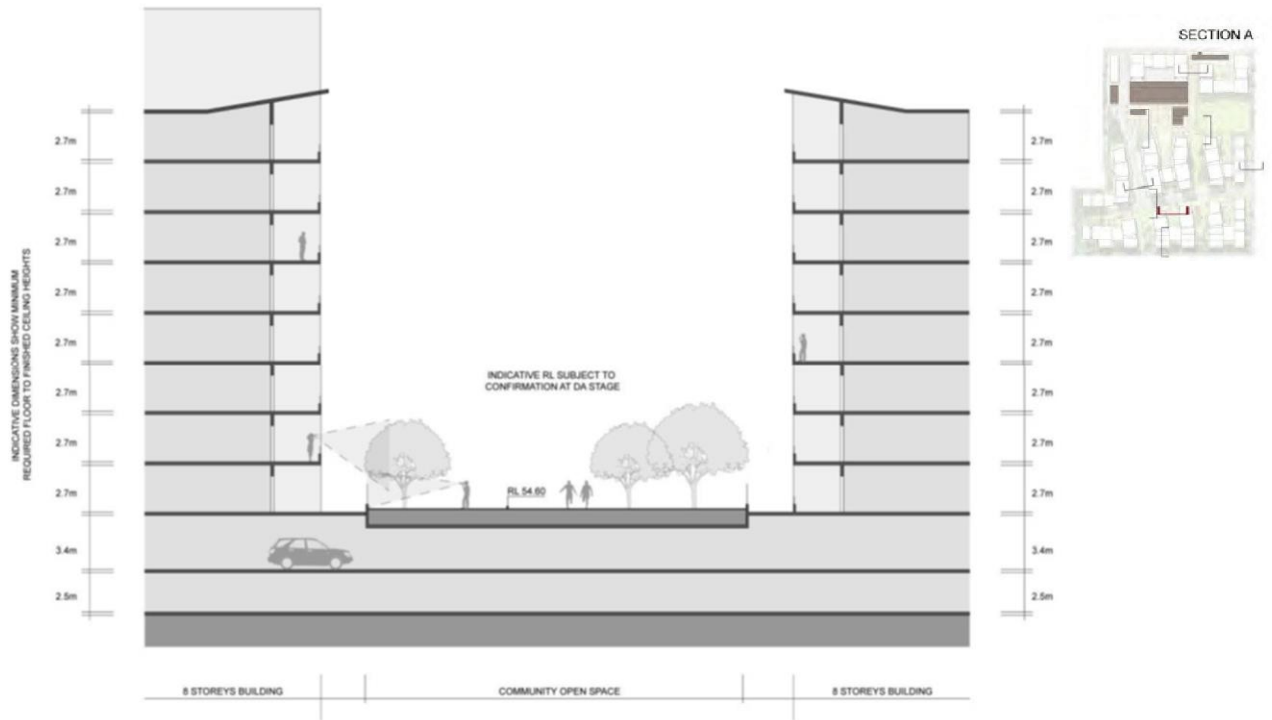

Figure 7: Indicative pocket park section

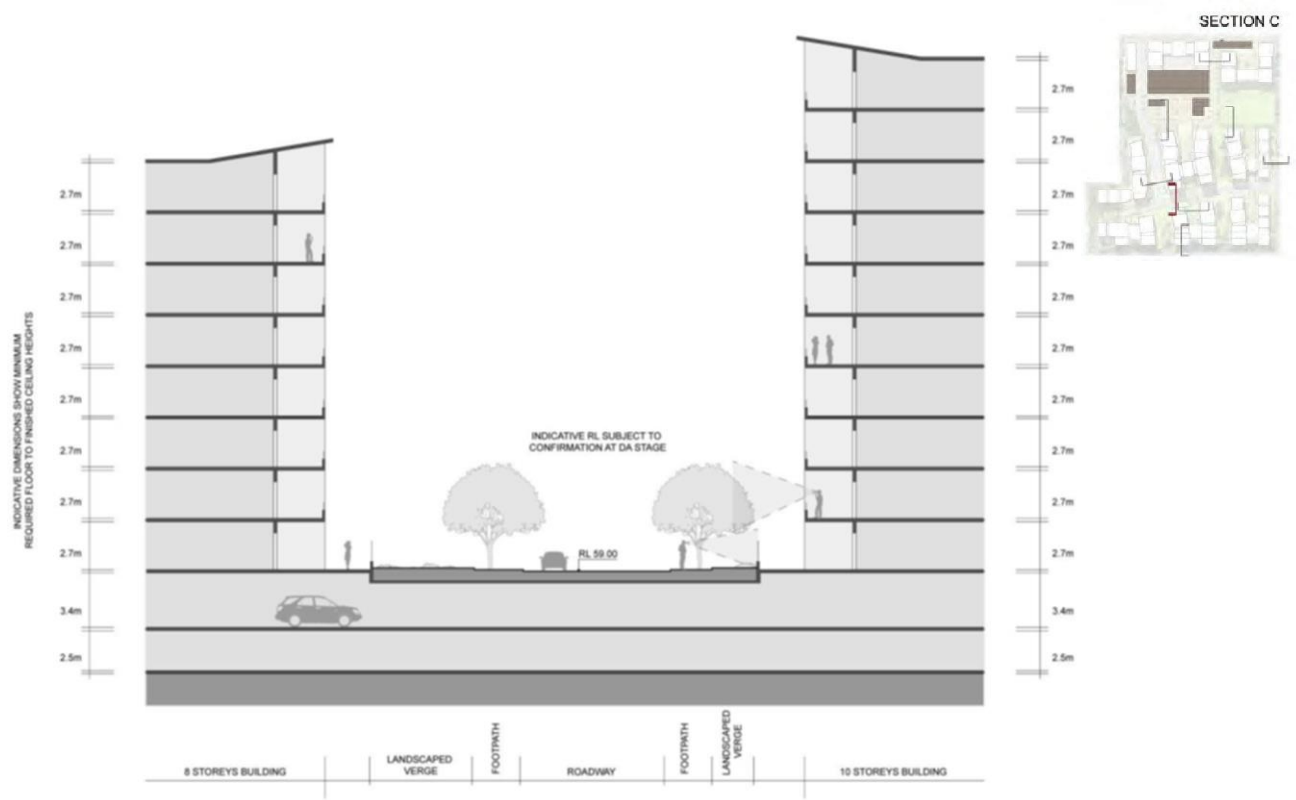

Figure 8: Indicative internal street section

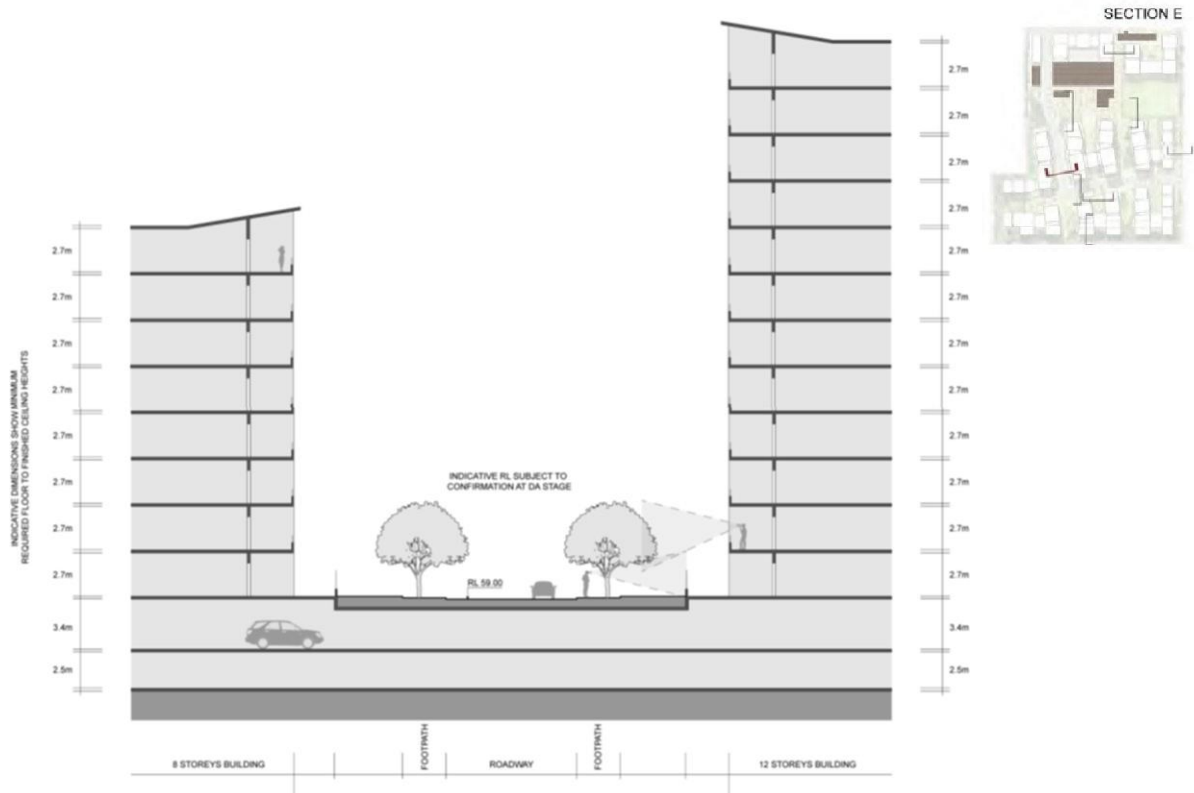

Figure 9: Indicative internal street section

### 3.5 Open space

#### Objectives

- O1. Development provides for open space that includes a publicly accessible multi-use park for the precinct and surrounding Pendle Hill community.
- O2. Development provides for public and private open spaces that are well located and accessible, forming an interconnected network of green spaces.
- O3. Development provides for public and private open spaces that have a layout, design, area and dimensions that are useable and fit for their intended purpose.
- O4. Development provides for public and private open spaces that have a high level of amenity, including adequate solar access.
- O5. Development provides for public and private open spaces that where publicly accessible, are physically and visually accessible and permeable, and are directly overlooked and activated by adjoining uses.
- O6. Development provides for public and private open spaces that have a coherent, legible landscape character, and offers a high level of visual amenity.
- O7. Development provides for public and private open spaces that cater for a diverse range of informal passive and active recreation activities.

- O8. Development provides for public and private open spaces that cater for biodiversity, enable infiltration of stormwater into the ground and improves microclimate.
- O9. Development that enhances the surrounding and internal street landscapes with quality landscaping and architectural responses, to facilitate a network of green links.
- O10. Development promotes social cohesion and a sense of community through providing spaces that cater for organised and informal community gathering and interaction.

**Controls**

- C1. Development creates a publicly accessible multi-use public park having a minimum area of 5,500sqm on the northern part of the site that is located between the heritage buildings and new development and has substantial frontage to Jones Street.
- C2. The multi-use park includes the following facilities:
  - soft and hard landscaping for passive recreation and active play;
  - adaptable playground areas; and
  - amenities such as BBQ facilities, shade structures, seating, lighting, bins and signage.
- C3. Development provides for continuous linear space through-site links between development blocks that provide a physical and visual connection between the multi- use public park and public plaza and the site's southern boundary.
- C4. Development includes at least five public pocket parks distributed throughout the precinct.
- C5. Development provides for approximately 25,000sqm of publicly accessible open space.
- C6. Where possible, public open space includes areas for community gardens in locations that do not compromise the useability of the space for informal active and passive recreation activities.
- C7. Publicly accessible open space is provided with a range of amenities such as seating, lighting, paving and BBQ facilities.
- C8. A minimum of 4 hours of solar access should be maintained to at least 60% of the public park on June 21.
- C9. Open space is provided generally in accordance with Figure 10.  
  
Indicative sections of the public park and marketplace plaza are provided in Figure 11 and 12.
- C10. Existing significant trees around the perimeter of the site, in particular those that provide a screening function for adjoining uses, are retained where not required for site access points, and are integrated into the prevailing landscape character of the precinct.
- C11. Development provides for:
  - public open space;
  - private communal open space;
  - private, individual use open space; and
  - landscaped areas and deep soil areas.

- C12. Development includes a public plaza as an extension of the multi-use park that features a combination of hard paving and soft landscaping and caters for informal community gathering and interaction, including occasional events.
- C13. Deep soft landscape areas are located between buildings and the southern boundary of the site.
- C14. Plantings in open space areas incorporate a diverse selection of locally native species including trees, shrubs and grasses/groundcovers.
- C15. Except for the public plaza, public open space optimises permeable soft landscaping such as turf and planted areas.
- C16. Open space includes sufficient area for deep soil planting to support large, spreading canopy trees.
- C17. All streets:
- include a minimum 4m landscaped verge on both sides; and
  - are generally in accordance with the landscaping elements shown in Figures 11 and 12.
- C18. Extensive, co-ordinated tree plantings are provided within new street reserves.
- C19. Development creates a community precinct focussed within and around the heritage buildings that includes public open space and non-residential uses.
- C20. Development facilitates public access to the site by maintaining strong connections and a permeable pedestrian and public open space network.
- C21. Development includes community gardens.



Figure 10: Open space network

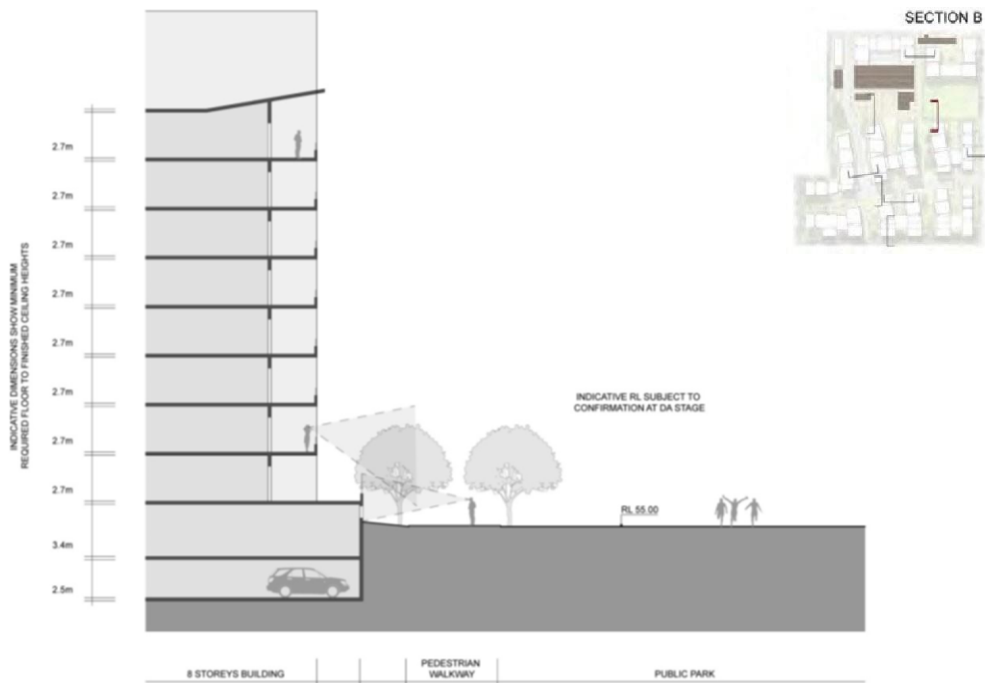

Figure 11: Indicative section of public park



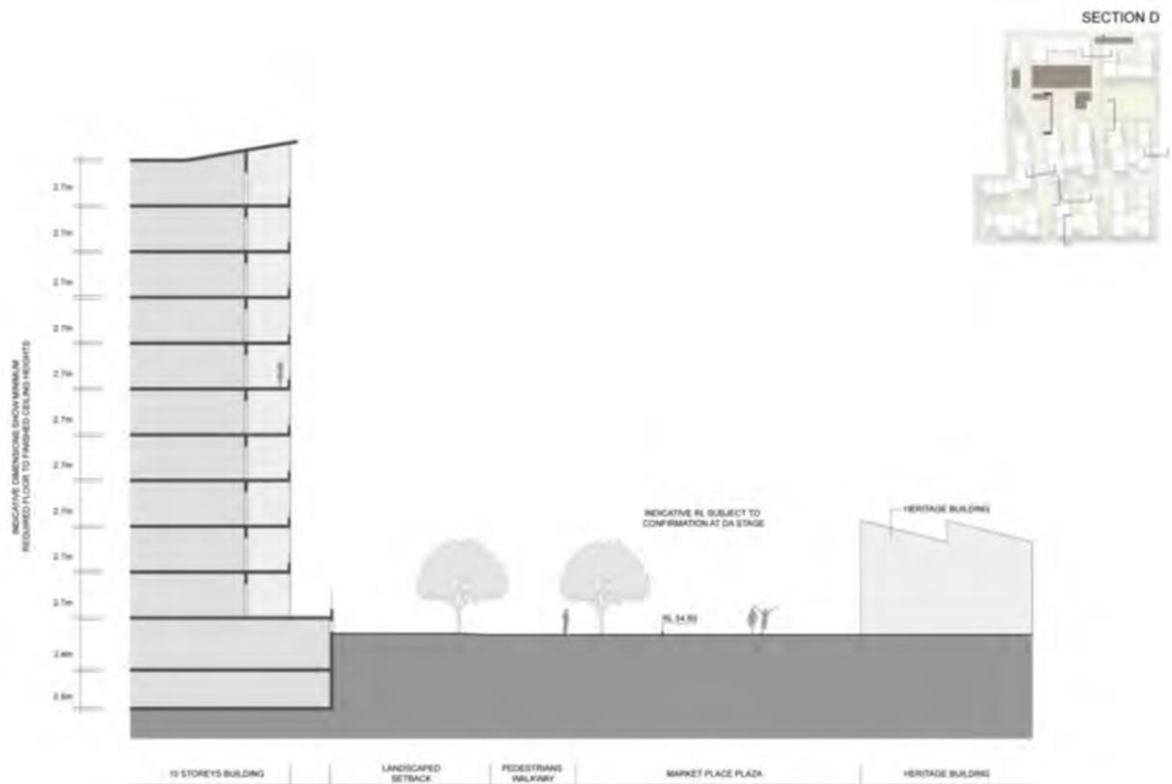

Figure 12: Indicative section of marketplace plaza

### 3.6 Movement network

#### Objectives

- O1. The movement network provides for multiple points of public access to the precinct.
- O2. The movement network is functional and provides for the efficient and safe movement of vehicles, pedestrians and cyclists.
- O3. The movement network provides a comfortable and attractive environment for pedestrians and cyclist.
- O4. The movement network where appropriate, provides opportunities for social interaction and gathering.
- O5. On-site car parking is provided at a rate that balances the need to provide for the convenience needs of residents and visitors with encouraging more sustainable forms of movement such as the public transport, walking and cycling for commuter and recreational trips.
- O6. On-site car parking is provided in a form that reduces overall building size and enables the creation of a positive relationship between buildings and the adjoining public domain, in particular through high levels of integration at the ground level.

#### Controls

- C1. The street network, pedestrian network, site access and car access points are provided generally in accordance with Figure 13 – Movement Network.

- C2. The existing street network is extended into the site to provide for at least one vehicle access onto Dunmore Street and one access on to Jones Street.
- C3. Vehicle ingress and egress to the site is two-way.
- C4. Pedestrian and cyclist movement is prioritised over vehicular movement.
- C5. Streets include pedestrian paths on both sides.
- C6. The pedestrian and cycle access network:
- is direct and accessible to all;
  - is easily identified by users;
  - has a public character;
  - includes signage advising of the publicly-accessible status of the link and the places to which it connects;
  - is clearly distinguished from vehicle access-ways; and
  - allows visibility along the length of the link to the public domain at each end
- C7. Strong, legible pedestrian connections are established between the site and adjoining areas.
- C8. The pedestrian and cycle access network:
- aligns with breaks between buildings so that views are extended and the sense of enclosure is minimised;
  - includes materials and finishes (paving materials, tree planting, furniture etc.) integrated with adjoining streets and public spaces and be graffiti and vandalism resistant;
  - is well-lit to safety standards;
  - is open to the sky along the entire length; and
  - is accessible 24 hours a day.
- C9. Provision is made to allow possible future connections from the site to the south
- C10. Street furniture is provided and includes a high quality, durable and co-ordinated selection of:
- paving;
  - seating;
  - lighting;
  - rubbish bins; and
  - signage.
- C11. Street trees are to be provided within deep soil zones on all streets that:
- comprise a co-ordinated palette of climatically responsive species;
  - are robust and low-maintenance;
  - are planted in a co-ordinated, regularly spaced and formalised manner;
  - increase the comfort of the public domain for pedestrians, including through the provision of shade in summer; and
  - enhance the environmental performance of the precinct by increasing opportunities for energy conservation.
- C12. In areas where deep soil zones cannot be achieved, suitable trees species still:
- comprise a co-ordinated palette of climatically responsive species;
  - are robust and low-maintenance; and

- provide adequate canopy shade, for the comfort of pedestrians.
- C13. On-site car parking is provided in accordance with Part G, Cumberland DCP 2021.
- C14. Carpark access is co-ordinated to provide for efficiently and convenience while not adversely affecting the pedestrian movement or the visual amenity of the public domain.
- C15. On-site resident car parking is provided in basement form.
- C16. Basement car parking protrudes above ground level:
- for ventilation purposes only; and
  - for a maximum height of 1m.

### 3.7 Managing transport demand

#### Objective

- O1. Ensure that the transport demand generated by development is managed in a sustainable manner.

#### Controls

- C1. All development applications are to include a 'Transport Impact Study' addressing the potential impact of the development on surrounding movement systems, where the proposed development comprises:
- non-residential development of more than 1,000m<sup>2</sup> GFA;
  - residential development of 100 or more new dwellings; or
  - likely to generate significant traffic impacts according to the consent authority.
- C2. The development application and applications for subdivision are to include a site wide 'Green Travel Plan' to outline initiatives for walking, cycling and the use of public transport. The Green Travel Plan should address different transport needs and patterns for residential and non-residential uses. Where relevant, initiatives are to be implemented prior to the issue of an Occupation Certificate.
- C3. All development applications are to include a 'Transport Access Guide', and a strategy for its future availability to residents, employees and visitors, where the proposed development comprises:
- Multi-dwelling housing; or
  - Non-residential development more than 1,000m<sup>2</sup> GFA.
- C4. Residential development within an 800m radial catchment of a railway station must provide at least one car-share parking space for every 100 dwellings.
- C5. Car-share parking spaces are included in the maximum number of visitor car parking spaces required for a development in Part G - Miscellaneous Controls, *Cumberland DCP 2021*.
- C6. Car-share parking spaces must be publicly accessible at all times, conveniently located, adequately lit and identified with sign-posting and road marking.
- C7. Car-share spaces must comply with the relevant Australian Standard.
- C8. Written evidence must be provided with the construction certificate demonstrating that offers of a car space to car-share providers have been made together with the outcome of the offers or a letter of commitment to the service.

- C9. All car-share parking spaces are to be retained as common property by the Owners Corporation of the site. A covenant is to be registered with the strata plan advising of any car-share parking space. The covenant is to include provisions that the car-share parking space(s) cannot be revoked or modified without prior approval of Council.
- C10. End-of-trip facilities including showers and lockers must be provided to adequately service the number of bicycle parking spaces required for employees in commercial premises and are to be located close to the bicycle parking area, entry/exit points, and within an area of security camera surveillance preferably where there are such building security systems.

*Note: Council will give consideration to granting a floor space exemption where the applicant demonstrates the provision of end of trip facilities within the residential and commercial components of the development.*



Figure 13: Movement network

### 3.8 Heritage

#### Objectives

- O1. All development seeks to respect and celebrate the site's former use as the Bonds Spinning Mill.
- O2. All development seeks to identify the potential for archaeological remains.

- O3. All development seeks to ensure adequate protection and best-practice management of archaeological relics.
- O4. All development seeks to minimise the potential for the disturbance of archaeological relics likely to be located on the site.

### **Controls**

- C1. The following heritage buildings are retained as shown in Figure 14:
  - Administration Building;
  - Dance Hall;
  - Cutting Room;
  - Cotton Bale Stores; and
  - John Austin Centre
- C2. Development is sited and designed in accordance with Section 11.10 of the Conservation Management Plan (Design Guidelines). Refer to Council's website for a copy of the CMP.
- C3. Retained heritage building are sympathetically restored, adaptively re-used and integrated with the balance of the precinct.
- C4. The spaces around the heritage items are accessible to the public.
- C5. New buildings adjacent to heritage buildings shown in Figure 14, are to achieve proportional relationships, including:
  - fenestration proportions;
  - materiality; and
  - key elevational alignments.
- C6. New development which falls within, or adjoins heritage curtilage zones, requires consideration of building materials that are complimentary to the retained heritage buildings, and are sympathetically designed in accordance with the CMP.
- C7. Industrial archaeology such as information signage and public artwork is distributed throughout the site to provide a time line highlighting important events and characters from the site's history.
- C8. The first development application is supported by a public art and interpretation strategy that complies with these controls.
- C9. View corridors are provided from the public plaza to Dunmore House and from Jones Street through the multi-use park to the John Austin Centre.
- C10. An historical archaeological assessment should be prepared by a suitably qualified and experienced historical archaeologist to inform the redevelopment of the site. This assessment should clearly identify and assess the potential for archaeological relics and engineering works, including providing an assessment of their significance in accordance with the NSW Heritage Division Guideline: *Assessing Significance for Historical Archaeological Sites and Relics, 2009*. The assessment should then consider what impacts, if any, the proposed activity will have on any potential archaeological resource and include appropriate recommendations for its management according to significance. The Assessment should be submitted to Council for consideration in support of the first development application.



- C11. Where the assessment determines that the development would disturb a potential historical archaeological resource, an application for an excavation permit under the *Heritage Act 1977* (NSW) must be submitted to the NSW Heritage Council. A copy of the report and the permit are to be provided to Council with the development application.
- C12. The applicant is to lodge, prior to issue of a Construction Certificate, a Construction Heritage Management Plan which addresses the following:
- Mitigation measures that will be in relation to the likely archaeology onsite;
  - The proposed monitoring in place for any archaeological relics uncovered;
  - Training, resources and consultation for staff on the site during excavation;
  - Incident management protocol; and
  - Methods dealing with unexpected finds during works.
- C13. During the development, if any archaeological remains are discovered, the developer is to stop works immediately and notify the NSW Heritage Division and Council. Any such find is to be dealt with appropriately, in accordance with the *Heritage Act 1977* (NSW), and recorded, and details given to Council prior to the continuing or works.



Figure 14: Heritage

This page has been left intentionally blank.



CUMBERLAND  
CITY COUNCIL

**PART F1- 4  
BRADMAN STREET,  
GREYSTANES  
(PROPOSED  
DEVELOPMENT AND  
SUBDIVISION)**



This page has been left intentionally blank.

## 1. Introduction

### 1.1 Land to which this section applies

This section applies to land situated in the Cumberland City being Lot 5 DP 20650, Lot 6B DP 413844 and Lots 16 and 17 DP 238362, as shown in the diagram below.

This plan aims to provide a cul-de-sac at the eastern end of Bradman Street, Greystanes.

## 2. Specific Objectives and Controls

### Objectives

- O1. Facilitate the conventional subdivision of Lot 5, DP 20650, Lot 6B DP 413844, Part Lot 16 and Lot 17, DP 238362 into 12 lots; and
- O2. Prevent the linking of the existing sections of Bradman Street.



Figure 1: Bradman Street subdivision map

This page has been left intentionally blank.



CUMBERLAND  
CITY COUNCIL

# **PART F1-5 CROSBY STREET, GREYSTANES**

This page has been left intentionally blank.

# 1. Introduction

## 1.1 Land to which this Part applies

This section applies to lands at Crosby Street precinct, Greystanes, as indicated in Table 1 and shown on Map 2.

# 2. Vision

As of 2010, Crosby Street, Greystanes, has been divided into two, unconnected sections. This section of the DCP is intended to guide future subdivision within the precinct to ensure that the two sections are connected, that development addresses the completed Crosby Street and that additional vehicular access from the parallel Great Western Highway is minimised.

# 3. Specific objectives and controls

## Objectives

- O1. Facilitate the reasonable development of the Crosby Street precinct by permitting the completion of Crosby Street, Greystanes.
- O2. Minimise the number of properties with vehicular access from the Great Western Highway.
- O3. Ensure that further development results in the completion of Crosby Street.
- O4. Ensure that development addresses both sides of Crosby Street.

## Controls

- C1. This section of the DCP applies to all development within the Crosby Street precinct, as indicated in Table 1 and shown in Figure 1.
- C2. Development for the purposes of the erection of a new detached dwelling house and additions and alterations to an existing, detached dwelling house is excluded from the provisions of this section.
- C3. Subdivision of land in this precinct shall not result in:
  - lots having a maximum dimension of more than 37m; or
  - hatched-shaped allotments having vehicular access from the Great Western Highway.
- C4. Land shall be dedicated for the Crosby Street extension in accordance with Figure 2 for a 15m wide road reservation.
- C5. A 7.5m wide vehicular carriageway shall be constructed along the proposed extension of Crosby Street, with a 3.75m footpath verge with a roll-top kerb along either side to match adjoining.
- C6. Road layout and geometry shall be in accordance with the provisions of Part A and G of this DCP and with other approved standards, either the *Guide to Traffic Engineering Practice* published by NAASRA, or the Roads and Maritime Services guidelines.

- C7. All roadworks, including drainage, kerb and gutter and footpaths, shall be constructed at the applicant's expense and the required land dedicated to Council prior to release of any Subdivision or Occupation Certificate. Alternatively, Council may accept lodgement of a bond, through a bank guarantee, for the agreed value of the works plus interest for 10 years, in lieu of construction of the works.
- C8. Where hatched shaped allotments are created with frontage to both the Great Western Highway and the Crosby Street extension, a restriction to use under Section 88B shall be included upon the title, with Council listed as a party, to require no access from the Great Western Highway, upon extension of Crosby Street to the subject property.
- C9. Temporary access shall be permitted from the Great Western Highway until such time as all land dedication and road construction for the Crosby Street extension is completed to the subject property.
- C10. Approval of temporary access from the Great Western Highway shall be subject to the agreement of the Roads and Maritime Services and any affected landholders.
- C11. Where temporary access from the Great Western Highway has been permitted, the following works shall be carried out at the expense of the landowner(s) at such time as the Crosby Street extension is completed to the subject property:
- all necessary works to permit vehicular access from Crosby Street, including removal of fences and construction of a suitable vehicular driveway from the property boundary to the kerb-line;
  - all necessary works required to deny access from the Great Western Highway, including erection of fencing at the property line and removal of any vehicular driveway from the property boundary to the kerb-line.
- C12. Development shall not extinguish the existing right of carriageways linking Crosby Street and Great Western Highway located on 477 and 485A Great Western Highway.

Table 1: Land subject to Section 1 of this Part.

Property Address	Lot No.	DP
22 Crosby Street, Pendle Hill	402	564607
467 Great Western Highway, Pendle Hill	1	1129553
469 Great Western Highway, Pendle Hill	401	564607
471 Great Western Highway, Pendle Hill	10	793480
475 Great Western Highway, Pendle Hill	2	217021
477 Great Western Highway, Pendle Hill	7	862464
485A Great Western Highway, Pendle Hill	10	1050994

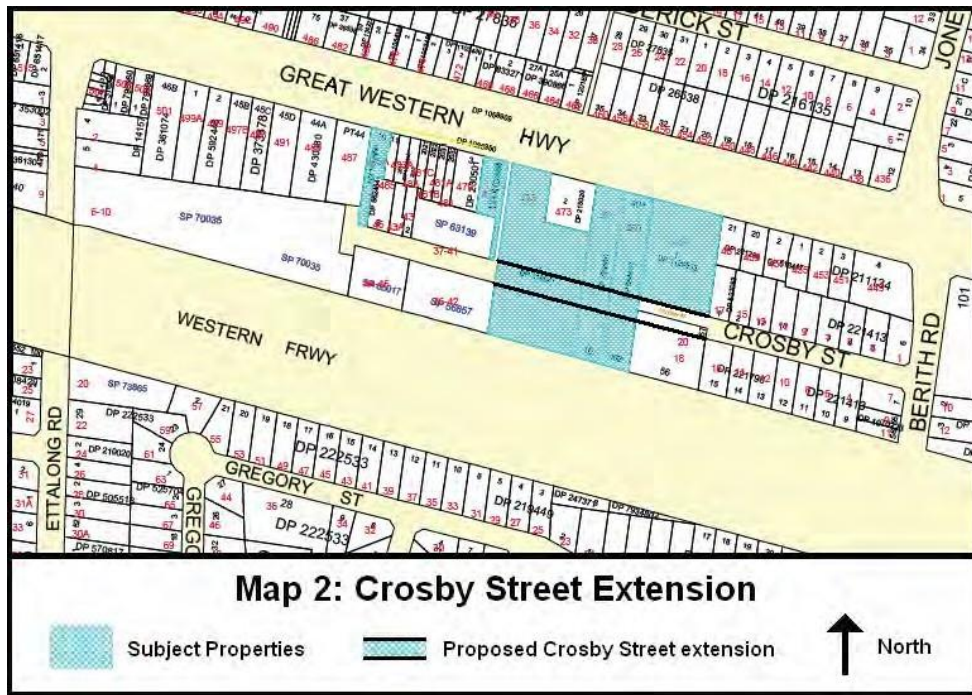

Figure 1: Crosby Street map



This page has been left intentionally blank.



CUMBERLAND  
CITY COUNCIL

# PART F1-6

# FOREST GUM ESTATE

This page has been left intentionally blank.

## 1. Introduction

The Forest Gum Estate, Greystanes is intended to be developed as a low density residential area.

As a response to potential over development, it is intended to impose additional development controls which would apply to this site. Rather than limiting the range of building forms by providing additional FSR controls, it is considered appropriate to contain development within an appropriate building envelope. In addition, controls on the minimum amount of private open space will ensure that sufficient private open space is provided for each dwelling.

As the Forest Gum Estate is a comparatively large development, it is appropriate to designate significant trees subject to Council's Tree Management Order and provide soil erosion and sedimentation controls within this Development Control Plan.

### 1.1 Land to which this Part applies

This section of the DCP applies to land outlined in heavy black as shown on the plan map below.

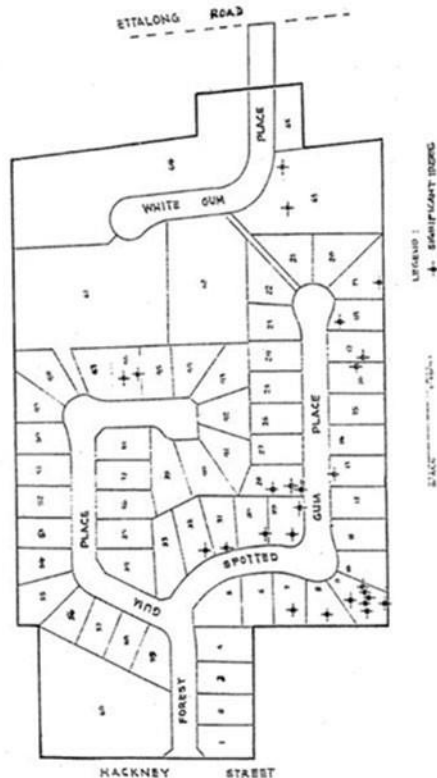

Figure 1: Forest Gum Estate map

## 2. Specific objectives and controls

### Objectives

- O1. Ensure the low density development is consistent with that allowed under the R2 zone of *Cumberland LEP 2021*.
- O2. Ensure a building envelope is provided to contain the bulk and scale of development.

- O3. Ensure significant trees are identified and protected.
- O4. Ensure controls are provided relating to soil erosion and sedimentation during construction and building works.

*Note: The provisions of Part B of this DCP relating to one and two Storey Residential Development” and “Dual Occupancy” specifically apply to the subject land except where the provisions of this section apply.*

**Controls**

Private open space

- C1. A minimum area of 80m<sup>2</sup> excluding side and rear setbacks shall be provided as usable private open space for each allotment.

Tree management

- C2. Those trees identified as being significant on the map are subject to the provisions of Cumberland City Council's Tree Management Order.
- C3. Those trees identified as being significant on the map are subject to the provisions of Cumberland City Council's Tree Management Order.
- C4. In respect of Lot 9 DP 845448 shown on the map Council may consider the removal of trees provided four significant trees are retained and a schedule of replacement trees is provided to the satisfaction of Council.

Soil erosion and sedimentation

- C5. Measures to prevent soil erosion and sedimentation as detailed in Part G of this DCP.

This page has been left intentionally blank.



CUMBERLAND  
CITY COUNCIL

# **PART F1-7**

## **FORMER LIDCOMBE HOSPITAL SITE**

This page has been left intentionally blank.



# 1. Introduction

## 1.1 Land to which this Part applies

This Part applies to land zoned R3 Medium Density Residential under the provisions of *Cumberland LEP 2021* and known as the Former Lidcombe Hospital site, as shown in Figure 1 below.

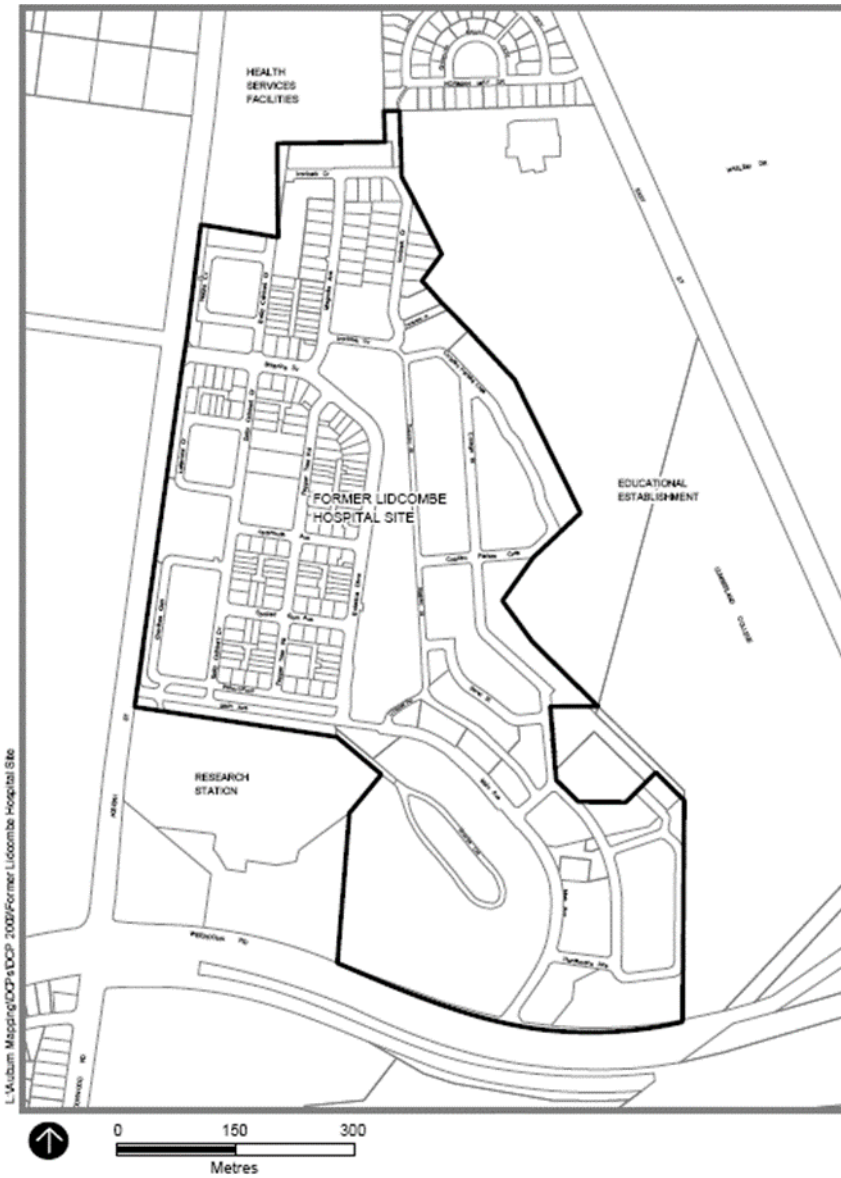

Figure 1: Area to which this Part applies

Where there is an inconsistency between this Part and other Parts within this DCP, the provisions of this Part prevail.

## 2. General objectives

This Part seeks to ensure that re-development achieves the following objectives and outcomes:

- O1. The site, when re-developed, maintains its uniqueness and character.
- O2. Future development retains and responds to key characteristics of the site.
- O3. The features of the site are integrated into the overall planning of the site.
- O4. Retention, adaptive reuse and integration of significant and other buildings to give unique character to the site, to enable future generations to read the “story” of the site and to reduce waste through reuse of existing building fabric.
- O5. Retention of significant remnant vegetation, cultural plantings and landscape features in the public domain and retention of significant road alignments, to protect and enhance biodiversity and ecological niches.
- O6. Provision of employment opportunities and opportunities for cultural development by providing for mixed uses in key heritage buildings.
- O7. Provision of a range of quality open space to meet passive and active recreational needs of the community (excluding organised sport) in locations that are easily accessible and in locations that maximise the retention of key landscape features and significant vegetation in the public domain.
- O8. Integration of landuse and transport planning by providing pedestrian, bicycle and transport connections within the site and between the site and its surrounds by way of bus transport and by co-location of services, facilities and employment opportunities.
- O9. Development of safe, well designed subdivisions, residential areas and dwellings, taking account of energy efficiency and efficient water management principles.
- O10. Create a sustainable community socially, culturally, environmentally and economically.
- O11. Ensure that a comprehensive ecologically sustainable development (ESD) strategy applies to the design, development, conservation, construction and maintenance processes.
- O12. Ensure that ESD principles underpin the overall development including the design of dwellings and living areas.
- O13. Retain and reuse the existing buildings, where possible.

### 2.1 Staged development

On 7 July 2004, consent orders were issued by the Land and Environment Court approving development application number 572/02 for the staged development of the site for subdivision, civil works including roads, drainage and provision of open space, demolition of buildings, regrading, landscaping, removal of trees, site remediation and separate access and uses.

### 2.2 Terms Unique to the Part

#### Studio accommodation

Are a room or suite of rooms no greater than 55m<sup>2</sup> in floor area located over a garage which is not part of the front streetscape. The rooms are capable of separate occupation.

Terrace houses

Are a form of multi dwelling housing. They are dwellings that have a common side wall(s) with an adjoining dwelling(s) in a group of three up to a maximum of 8 dwellings where the garage is detached from the dwelling and is accessed from the side or rear of the lot.

Town houses

Are a form of multi dwelling housing. They are dwellings that have a common side wall(s) with an adjoining dwelling(s) in a group of three up to a maximum of 8 dwellings where the garage is attached with the dwelling at the front or side.

### 3. Specific objectives and controls

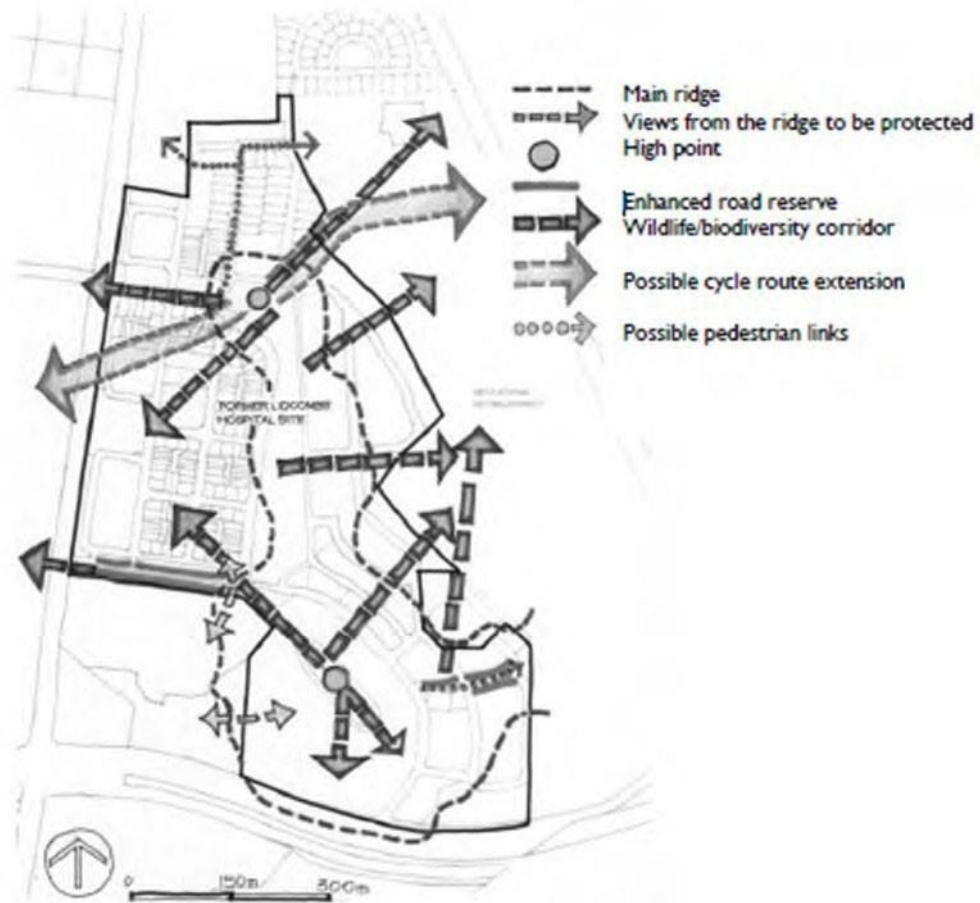

**Figure 2 – Key features.**

*Figure 2: Key features*

### 3.1 Planning Principles

This section sets out requirements that apply to the overall urban design and structure planning for the site. The key objective of this section is to ensure that the urban design/structure plan for the site retains key features (see Figure 2) of the site and responds to these.

#### 3.1.1 Built elements to be retained

##### Objectives

- O1. Ensure that, wherever possible, existing buildings and road alignments are retained and adaptively reused.
- O2. Ensure that future generations are able to interpret the history of the site.
- O3. Individual buildings of significance are to be retained and conserved, or adaptively reused, on the site to achieve quality conservation and urban design outcomes.
- O4. Retain road alignments of significance to contribute to the historical layering of the site.

##### Control

- C1. Buildings and elements to be retained shall be detailed in the plans approved as part of the determination of development application number 572/02 (as amended) for the staged development of the site.

#### 3.1.2 Landscape elements to be retained

##### Objectives

- O1. Ensure that overall landscape integrity of the site is retained.
- O2. The landscape integrity and natural and cultural attributes of the site are utilised as opportunities to define the structure of future development on the site by:
  - using the natural lines of drainage to define the location and form of streets and open spaces;
  - protecting the ridge top and high points within the public domain;
  - protecting significant tree groups within the public domain;
  - protecting individual significant trees within the private domain, where it is not possible to protect in the public domain;
  - responding to the different topography and character of the site on the western and eastern sides of the ridge;
  - retaining existing water bodies and water detention basins as part of an ecologically sustainable approach to stormwater management;
  - protecting the visual prominence of the site and protecting significant views from the site along the main ridge; and
  - protecting significant remnant vegetation within the public domain.

##### Control

- C1. Landscape elements shall be retained and incorporated into the overall urban design in accordance with the performance criteria above.

### 3.1.3 Open space

#### **Objectives**

- O1. Ensure that a variety of quality, conveniently located open space is provided to meet diverse passive and active recreation needs of the community, and where possible, to protect and promote biodiversity.
- O2. Ensure that the open space network provides high quality and diverse recreational opportunities and responding to the special features of the site by:
  - locating open space to protect significant tree groups;
  - locating open space to protect significant remnant vegetation;
  - locating open space to protect and highlight topographical features such as high points, ridgelines, drainage lines and other features;
  - protecting significant heritage items;
  - integrating stormwater management;
  - protecting the landscape frontage to the site along Joseph Street;
  - locating open space to reinforce pedestrian legibility and permeability through the site; and
  - creating wildlife corridors linking across the site from Rookwood Cemetery to Carnarvon Golf Course.

#### **Control**

- C1. Public open space shall be provided as detailed in the plans approved as part of the determination of development application number 572/02 (as amended) for the staged development of the site.

### 3.1.4 Street layout

#### **Objectives**

- O1. Ensure that the road and street layout respects the history of the site and responds to key characteristics of the site.
- O2. The roads and streets on the site are to be designed to respond to the site character by:
  - respecting and retaining the significant existing road patterns, structure and character where possible;
  - retaining the ridge road through the site as the main collector road;
  - responding to existing site topography when determining street alignments;
  - minimising cut and fill;
  - protecting significant landscape or built elements;
  - defining property boundaries or neighbourhood boundaries;
  - fronting onto open space areas;
  - providing opportunities for linkages to adjoining uses; and
  - defining clear residential and open space precincts.
- O3. The street pattern is organised so that
  - the heritage buildings and landscape are retained and fully integrated into the development;
  - there are long sight lines affording views and vistas; and
  - the undulations of the topography are clearly visible.

**Control**

- C1. The street layout shall be detailed as shown in the plans approved as part of the determination of development application number 572/02 (as amended) for the staged development of the site.

3.1.5 Street hierarchy

**Objectives**

- O1. Strengthen links and interconnections with adjoining sites.
- O2. Minimise the adverse impacts of vehicular traffic on future residential environments.
- O3. Optimise links to the surrounding road network and adjoining uses by:
- providing the main site entry of Joseph Street at the existing traffic lights;
  - providing a secondary site entry point on Joseph Street with limited turns (left-in and left-out);
  - upgrading the existing site entry on Weeroona Road;
  - providing continued access to the MS Society site and Ferguson Lodge via the local road network;
  - allowing for future road connections to the TAFE and University to the east of the site; and
  - ensuring all roads (except laneways) are public streets.
- O4. Minimise the impact of vehicular traffic on the amenity of the future residential environment by:
- providing a hierarchy of streets that concentrates the principal traffic on a collector road through the centre of the site;
  - designing local streets to be low speed low volume roads that offer high pedestrian and residential amenity;
  - providing rear laneways for private access to garages to reduce the visibility of garages on primary street frontages; and
  - creating a landscape framework that reinforces the hierarchy of the streets.

**Control**

- C1. The development shall adopt the street hierarchy consistent with the plans approved as part of the determination of development application number 572/02 (as amended) for the staged development of the site.

3.1.6 Pedestrian and cycle circulation

**Objectives**

- O1. Encourage and facilitate walking and cycling within the site and the general neighbourhood.
- O2. Encourage use by pedestrian and cyclist use of the site by:
- providing footpaths on all streets on the site;
  - providing safe and high amenity pedestrian linkages connecting all major activities and open spaces;
  - providing a cycleway through the centre of the site following the route of the main collector road along the ridge;
  - designing for safe on-street cycling conditions along residential streets;
  - providing bicycle parking at key locations;

- providing new pedestrian and cycle access to adjoining housing development to the north and Coleman Park; and
- allowing for future pedestrian/cycle links to adjoining sites and regional routes and integrating accessibility for the mobility impaired.

**Controls**

- C1. Pedestrian and cycle routes shall be provided as shown in the plans approved as part of the determination of development application number 572/02 (as amended) for the staged development of the site.
- C2. Streetscaping/public domain design shall strengthen the role of these routes and take account of safety of these routes.

3.1.7 Car parking

**Objectives**

- O1. Maintain high amenity of the residential neighbourhoods and heritage precinct by ensuring that adequate provision is made for resident, non-resident and visitor parking.
- O2. Adequate car parking is to be incorporated on the site to cater for residents and visitors without compromising the setting and amenity of the residential environment by:
- ensuring all multi-unit dwellings have basement parking accessed from rear lanes;
  - limiting on-street parking to one side on local streets;
  - limiting parking along the main collector road, where necessary, to create a parkway character and enhance heritage setting; and
  - allowing small discrete car parking areas to the rear of buildings within the heritage core.

**Controls**

- C1. Public parking spaces shall be provided in addition to the resident parking provided for each dwelling.
- C2. Public domain, street and landscape design shall clearly delineate parking areas
- C3. All car parks shall be landscaped and screened.

3.1.8 Built form character and scale

**Objectives**

- O1. Ensure that new buildings enhance the overall character of the site.
- O2. The location, scale and character of new buildings are to protect the overall cultural significance of the site by:
- ensuring new buildings associated with the existing heritage buildings respect the scale, form and character of the heritage items;
  - protecting the existing physical and visual relationship between groups or complexes of buildings;
  - siting larger footprint buildings along the northern and eastern side of the site where there are less physical and cultural constraints; and
  - developing buildings which protect the amenity of open spaces and key views into and out of the site.



**Controls**

- C1. The design of new buildings shall emphasise the street and open space hierarchy by defining built edges through building setback, height, articulation and historic/distinct architectural form.
- C2. New development shall respond to and reflect the built form hierarchy.

**3.2 Heritage****3.2.1 Built heritage****Objectives**

- O1. Ensure that use of the buildings does not expose the building to unusual risk of damage.
- O2. Ensure that the heritage buildings are economically adapted and reused.
- O3. Ensure that the works and uses of the heritage buildings contribute to the integration of the heritage core and precinct to the development as a whole.
- O4. Ensure that the use of buildings does not compromise their heritage significance and does not expose the building to unusual risk of damage.
- O5. New development is to be compatible with the overall residential character of the former Lidcombe Hospital site and the heritage core precinct (as identified on the NSW State Heritage Register).
- O6. Ensure that the use of built heritage will not impact significantly on the heritage fabric of the building or reduce its heritage significance.
- O7. The use of built heritage will not result in risk of damage to the heritage fabric of the building by virtue of how the building is to be managed or the intensity of that use.

**Controls**

- C1. Buildings and landscape elements in the heritage core precinct shall be retained.

**3.2.2 Maintenance schedule****Controls**

- C1. The detailed maintenance schedule for all buildings identified for retention shall include: immediate works; 5 year; 10 year; and continuing maintenance schedule.
- C2. Specific levels of conservation/repair works for the buildings listed in the table above are required by this Part as follows:
- All items of exceptional, high and moderate significance be brought to the following level of condition prior to time of transfer, resale or lease.

Items of exceptional and high significance:

- All external fabric (including roofs, walls, windows, doors) shall be restored/repared to a level of condition which gives the basis of a habitable building as defined by Council.
- All infestations of pest and vermin in proposed retained buildings shall be controlled and damaged fabric restored/repared to a level of condition which gives the basis of a habitable building as defined by Council.



- All electrical, water, sewerage, gas services shall be restored/repared to a level of condition which will allow full and unrestricted use of the services in the building by a new occupant. This includes fixtures such as wires, pipes, switch boards, gas and water metres but does not include finishes and fittings.
- All interiors of items of exceptional and high significance shall be brought to a standard which provides the basis for a habitable interior as defined by Council.
- Interiors of items of exceptional significance as identified by Cumberland City Council are to be conserved and restored to the condition known at a determined date.

Items of moderate significance:

- Exteriors of items of moderate significance (to be retained) shall be repaired as required to an acceptable habitable standard.
- Interiors of items of moderate significance (to be retained) shall be retained/repared as required to an acceptable level which provides the basis of a habitable interior.

### 3.2.3 Archaeological heritage

#### **Controls**

- C1. Demolition and excavation of the site is to be carried out in accordance with the approved *Archaeological Management Plan* (which sits within the Conservation Management Plan). This work should also comply with the *Heritage Act 1977* and *Cumberland LEP 2021* in relation to development works and disturbance of potential archaeological resources.
- C2. The recording and conservation of archaeological resources shall be achieved in accordance with the heritage provisions of the *Heritage Act 1977*, *Cumberland LEP 2021* and with the approved *Lidcombe Hospital Site Archaeological Management Plan*.
- C3. Proposals for development and excavation of the site shall consider the need to obtain an excavation permit in accordance with the *Heritage Act 1977* and with reference to the *Conservation Management Plan* and *Archaeological Management Plan* referred to above. Permits will generally be required to carry out further archaeological assessment in areas identified as high or moderate archaeological significance prior to further site disturbance.

*Note: No further action is required in relation to archaeological resources in other areas of the site unless relics or evidence is discovered during site disturbance or excavation and either the provision of the Heritage Act 1977 applies relating to European relics, or the National Parks and Wildlife Act 1974 applies regarding indigenous sites.*

### 3.2.4 Landscape heritage

#### **Objectives**

- O1. The Main Avenue heritage landscape element is to be restored to replace missing elements such as plantings of pines and palms.
- O2. Any new development near heritage landscape elements are not to adversely affect the significance or character of those elements.
- O3. Any items of heritage landscape significance, which are considered unsustainable by virtue of health, longevity, safety or other relevant consideration, are to be replaced with suitable new plantings in accordance with the approved landscape master plan.

## Controls

- C1. The conservation of the heritage landscape elements must be achieved in accordance with the heritage provisions of the *Cumberland LEP 2021* and with the approved *Lidcombe Hospital Site Conservation Management Plan*.
- C2. Proposals for development of the site must be made in accordance with the approved *Lidcombe Hospital Site Conservation Management Plan and Heritage Impact Statement* prepared for the site, and take account of the landscape elements defined in the *Lidcombe Hospital Site Conservation Management Plan*.

*Note: In this section, a landscape master plan is the plan prepared by the applicant which accompanies the first stage development application. It sets out the general principles of embellishment to be undertaken in subsequent stages of the development of those areas where the developer intends to undertake the embellishment of local open space. The landscape master plan is to be consistent with the principles and requirements of the Lidcombe Hospital Site Conservation Management Plan, September 2002.*

## 3.3 Landscaping, public open space and public domain

### 3.3.1 Landscape Planting

#### Objectives

- O1. Retain and enhance existing endemic vegetation and biodiversity.
- O2. Retain significant heritage plantings.
- O3. Provide quality private open space to meet the recreational and living needs of residents.
- O4. Ensure that landscaping on private land contributes to the character of precincts and streetscapes.
- O5. Provide quality public open space and public domain.
- O6. Landscaping is to:
  - enhance the amenity of all areas of the development;
  - be easily maintained and robust; and
  - contribute to the landscape masterplan of the development.
- O7. Establish linkages and connections in the design of spaces through the selection of appropriate plant species.
- O8. The selection of plant species are to be based on the following:
  - appropriate remnant and endemic species;
  - solar access to private open space and buildings;
  - cultural landscape precedence; and
  - demonstrated performance suitability of species within the planting environment.
- O9. New plants are to be of species which are suited to the site conditions and have sympathetic character and style of the existing planted species.
- O10. Ensure that the proposed planting considers the species endemic to the Auburn area and the preferred plant species list contained in the *Auburn Parks Infrastructure Manual*. This Manual is available from Cumberland City Council on request.

### **Controls**

- C1. Existing vegetation consisting of significant heritage plantings and other mature plantings shall be retained when determining site layout and road alignments. The retention of these elements in development control shall be complemented with additional planting to provide identity to different parts of the development.
- C2. Retention of trees shall consider:
  - the safe useful life expectancy (assessed by a qualified arborist) and estimated future lifespan;
  - the current and future amenity and contribution to the landscape that the tree provides;
  - management and safety issues associated with retention; and
  - heritage considerations including the natural and cultural history of the site.
- C3. Landscape design of private lots and retained existing trees shall contribute to the landscape amenity of the neighbourhood and precinct landscape framework.
- C4. Street patterns and street tree planting shall be strong components of the landscape framework.
- C5. Streetscape planting shall ensure the coherence of new plantings and continuity with key elements and themes of the existing landscape.
- C6. The detailed landscape design of streets and pathways shall reinforce people's understanding of the street hierarchy.
- C7. Public open space areas shall be sized and designed as manageable parcels and readily accessible by maintenance personnel and equipment.

### 3.3.2 Public open space area

#### **Objectives**

- O1. Ensure the provision of open space to allow suitable access and locations for both active and passive recreation activities appropriate to the size and function of the open space area. (Note: appropriateness in this sense includes matching the type of activities encouraged on that space to the proximity of dwellings to minimise disturbance of residents. Adequate protection must be provided to ensure significant existing trees are not damaged by construction activities).
- O2. Ensure the retention and enhancement of existing significant vegetation contributes to the conservation of wildlife corridors.
- O3. Existing vegetation complements the overall landscape scheme for the site and provides variety and visual identity to different residential areas.
- O4. Open space associated with the heritage core precinct are to remain accessible to the public at all times.
- O5. Pedestrian and cycle crossings of roads are to be sited in high usage locations and provide adequate safety for motorists, pedestrians and cyclists.
- O6. Ensure that the design and layout of public open space takes advantage of available views and site features.

- O7. All open space areas are to be maintained to a high level to encourage resident usage and a sense of community ownership.
- O8. The public domain needs to create focal points for the community and a hierarchy of spaces that provide a local identity.
- O9. Landscape treatments are to be provided in open space areas in accordance with the landscape master plan.
- O10. All ponds within public open space areas are to have dual use functions for water treatment and be embellished for passive recreation with appropriate safety measures.

### **Controls**

- C1. Landscape plans for local open space shall be consistent with the principles and requirements of the approved *Lidcombe Hospital Site Conservation Management Plan*.
- C2. Open space areas shall be of manageable sizes and not fragmented pockets spread throughout the site.
- C3. Footpath links shall be provided to, and through, open space areas in accordance with open space embellishment plans.
- C4. Open space embellishments shall include some provision for car parking including parking for persons with disabilities.
- C5. The maximum gradient of footpaths and cycle ways shall be similar to the adjacent road pavement.
- C6. Shared pedestrian and cycle way paths along collector roads or through open space areas shall be 2.5m wide. A pedestrian footpath along local roads (where not a shared way) shall be 1.2m wide.
- C7. Open space areas shall be designed to minimise the risk of crime and provide links to other areas of open space and focal nodes within the site.
- C8. Significant vegetation shall be retained and included in embellishment designs wherever practicable and where medium to long term public safety and tree vigour can be expected.
- C9. Drainage facilities shall be designed to provide multi use recreation opportunities and to be incorporated as an integral component of the public open space network.
- C10. "Village green" within the heritage core shall be publicly accessible at all times.
- C11. Signage in accordance with Council requirements shall be provided in all public areas to indicate street names, essential service locations, pedestrian routes and public facilities.

## **3.4 Roads and access**

### **3.4.1 Roads, streets, lanes and footpaths**

#### **Control**

- C1. The following principles underpin the design of the roads, streets and lanes within the site:

- the internal circulation network will comprise a system of roads, streets, lanes and pathways servicing the development within the site;
- all roads shall be dedicated to Council except for lanes and access lanes; and
- the visual appearance of roads of different classification shall also convey the purpose and function of that road.

### 3.4.2 Hierarchy

#### **Objectives**

- O1. Provide a road and street hierarchy that is safe and efficient for vehicles as well as pedestrians and cyclists, endeavours to create safe travel speeds and minimises the adverse effects of through traffic.
- O2. Ensure that the road and footpath system is fully accessible for elderly and people with disabilities.
- O3. Ensure that there is a clear street hierarchy reinforced by building type.
- O4. Ensure that existing roadways and associated service infrastructure to be retained, upgraded if necessary and reused as road and/or pathways within the site.
- O5. Road and street hierarchy is reinforced through landscape embellishment.
- O6. Internal roads and intersections are controlled by appropriate low impact means to slow and control traffic movement.
- O7. Access to the arterial road system and the designated locations of an approved intersection form and design is to be satisfactory to the Roads and Traffic Authority (RTA).
- O8. Footpaths and roads are accessible to people with disabilities.

#### **Controls**

- C1. A network shall be established which provides convenient linkages for all modes of transport to all areas within the site and has regard to travel distances, drainage, public utilities and view corridors.
- C2. A network of roads, streets and lanes shall be provided with a clear physical and visual distinction between each type based on function, convenience, amenity, safety and traffic volume.
- C3. All junctions and intersections shall be detailed in response to the expected future traffic volumes and operational speeds, providing appropriate restraint of speed, clarity of priority, together with the safe accommodation of pedestrians' and cyclists' movements
- C4. The network of roads, streets and lanes shall generally conform to the functions as set out in Table 1.

Table 1: Road and street functions

Road Type	Max traffic volume (vpd)	Max number of dwellings	Design speed (kph)	Standard road reserve (m)
Collector Road	3,000	1,000	50	22.2
Local streets	1,000	200	40	13
Special streets	Variable	Variable	40	Variable
Lanes	160	16	10	7
Lane (access)	160	16	10	5

- C5. Any collector roads permitted to carry loadings in excess of 3,000 vpd shall not to have direct vehicular access from the adjoining properties, and shall make provision for the restraint of over-speeding, for ease of pedestrian/cyclist crossing, and for control of intersection movements.
- C6. Road and street lighting shall be compliant with the relevant Australian Standards to facilitate a safe environment for all users.
- C7. Landscape embellishment shall be themed and respond to the road hierarchy.
- C8. Acceptable levels of access, safety and convenience shall be provided to all users ensuring acceptable levels of amenity.
- C9. New development shall make adequate provision for bus services to service the site and ensure that road and kerb design can accommodate articulated low floor buses.
- C10. Non-resident parking and overflow parking from adjoining development shall be discouraged by the use of 'resident only' controls or other appropriate parking measures.
- C11. A legible, safe and convenient network of all weather pathways for pedestrians and cyclists, including users with disabilities and limited mobility, shall be provided in accordance with provisions contained in the Disability Discrimination Act 1992.
- C12. Cater for the integrated provision of landscaping, public utilities and drainage.
- C13. No direct vehicular access except at controlled intersections shall be permitted to arterial or sub arterial roads
- C14. Safe and convenient interaction between the use of the hall, particularly peak patron use, and the operation of the adjoining road and path/cycle ways shall be provided.
- C15. The location and design of road intersection junctions with Weeroona Road will consider sight distance and expected future traffic volumes.
- C16. Road geometry shall comply with the *RTA Road Design Guide*
- C17. Footpaths and road interfaces shall be in accordance with disability standards.

### 3.4.3 Design widths

#### Objectives

- O1. Ensure that sufficient carriageway and verge widths are provided to allow streets to perform the designated functions within the overall road network and to accommodate public utilities and drainage.
- O2. Ensure that the main collector road functions as a two way bus route that allows unobstructed movement in both directions
- O3. Ensure safety at bus stop areas.
- O4. Ensure that the overall dimension and appearance of the road network visually reinforces its intended function, and in particular conveys to motorists the appropriate travelling speed.
- O5. Align with the dimensions and characteristics of the urban road hierarchy set out in Cumberland City Council's *Development Design Specifications – D1 Geometric Road Design: Urban* (Auspec March, 2001). Possible flexibility on some of the criteria enables the development to meet best management practice and the desired outcomes.
- O6. The design and alignment of collector roads are provided for the efficient and unimpeded movement of buses and needs to comply with relevant State government agency and local contracted bus service provider requirements.

#### Controls

- C1. Street planting in publicly dedicated roads shall only be permitted following Council approval of a tree planting plan prepared by a qualified Landscape Architect. All plans documenting the location of proposed street planting shall indicate the location of all services, vehicular entry points, road crossing areas, designated bus stops, traffic signs and street lighting.
- C2. Carriageway and verge widths for particular street types are set out in Table 2 below:

*Table 2: Appropriate carriageway and verge widths for particular road types*

Type	Standard carriageway width (m)	Standard total verge width (m)	Standard road reserve (m)	Footpath required	Dedication to Council required
Collector Road	12.2	9	22.2	1.2m on both sides	Yes
Local streets	7.5	5.5	13	1.2m on one side	Yes
Special streets	Detailing to achieve heritage requirements.				
Lanes	4-5	2	7	No	No
Lane (access)	3	2-3	5	No	No

- C3. Where lanes do not front garages the width of the carriageway shall be reduced to a minimum of 3m where adequate provision has been made for passing oncoming traffic.
- C4. Collector roads fronting public open space may reduce the minimum verge width to 1m and reduce carriageway width by 2.6m (providing there is adequate parking space and road infrastructure requirements are allowed for).

### 3.4.4 Streetscape, lighting and signage

#### **Objectives**

- O1. Ensure the design of the streetscape contributes to a cohesive landscape theme that relates to the development concept for the site and complements the surrounding development.
- O2. New development is compatible with the existing character of the locality in the context of the heritage precinct.
- O3. Ensure that the development enhances the visual character and amenity of the street and reflects its function in the movement hierarchy developed for the site.
- O4. Ensure that street planting defines the public realm from privately owned areas and reinforces the character of various street types and locations.
- O5. Buildings are to address the street frontage and are compatible with adjoining development in terms of street elevation and presentation.
- O6. New buildings adjacent to items of heritage significance need to comply with the requirements of the *Conservation Management Plan* regarding appropriate scale, materials and finishes.
- O7. Ensure that the building heights at the street frontage do not dominate the streetscape.
- O8. Ensure that double garage doors do not dominate the streetscape.
- O9. Streetscape design should consider vehicle crossing points, pedestrian crossing points, visual amenity, fencing styles, lighting and any other necessary street furniture.
- O10. Signage is to be clear and visible and conform with relevant Council requirements.
- O11. Street trees should be planted in accordance with the landscape masterplan in particular its reference to the retention of existing trees in the plan.

#### **Controls**

- C1. Streetscape elevations shall be required for development applications for individual blocks. Individual buildings within a block shall be considered as part of a greater whole, with particular reference to the place-making principle of creating areas of distinct character by concentrating certain dwelling types together
- C2. Public street furniture shall include bus shelters, lighting poles and lighting, plant guards, barriers and signage and shall be of a design specified and approved by Council.
- C3. Choice of materials for hard surfaces, especially carriageways and footpaths/cycle ways shall be of a type and specification approved by Council. Changes in paving material will be allowed to signal changes in street use and character.
- C4. Street trees shall be planted at approximately 10m intervals or as otherwise in accordance with the approved landscape master plan. Plant selection and streetscape design shall consider:
  - species habit;
  - mature size of species;
  - requirement for evergreen or deciduous trees depending on aspect;



- likely impacts due to surrounding structures and services plus potential impact or nuisance from flower and/or fruit drop;
- lighting, visibility and safety considerations; and
- heritage items and landscape elements

### 3.4.5 Linkages

#### **Objectives**

- O1. Ensure that the access points to the site minimises travel, provide safe and efficient access.
- O2. Ensure that the transport network makes provision for access to adjoining land uses.
- O3. Ensure that links between the site and adjoining land uses are agreed to by the adjoining owners prior to inclusion in any development application.
- O4. Controls to discourage student parking within the Lidcombe Hospital site should be considered in consultation with Council.

#### **Controls**

- C1. Provision shall be made in this development for all classes of access to the Multiple Sclerosis facility and to Ferguson Lodge, and also consideration being given to facilitating possible future connections into the adjoining lands to the south-west of the site.
- C2. Pedestrian and cycle access shall be provided through to East Street and Norman May Drive; to Joseph Street/Georges Avenue signalled intersection by the shortest practicable and convenient route and provision shall be made for possible future connections to the educational institutions to the east.
- C3. The satisfactory management of the base, casual, and the peak parking loadings and the consequent use of the parking sites shall be provided, off-street and on-street, for all land uses.

### 3.4.6 Pedestrian and cycle network

#### **Objectives**

- O1. Ensure that the design of the development encourages residents to walk or cycle for trips within the site.
- O2. Establish a network of pedestrian linkages to allow residents, including disabled residents and visitors, easy and safe access to the open space and other public amenity features of the site and public transport.
- O3. Ensure that the cycle network is connected within the site and to other networks external to the site.
- O4. Ensure a clear distinction between designated local internal routes and those used to connect to external areas of the site.
- O5. Provide a pedestrian network of suitable material, width and design that can link to existing or possible future pedestrian networks on neighbouring areas and that is serviceable in all weather conditions.

- O6. Pedestrian links should function without conflict with cycle links and link key areas or high use areas of the site.
- O7. Provide a cycleway of suitable material, width and design that can link into existing or a possible future cycle link on neighbouring areas.
- O8. Provide safe pedestrian links throughout the site, to open space areas and to adjoining sites.
- O9. Provide a cycleway and pedestrian network to link to Joseph Street, Weeroona Street and Norman May Drive.
- O10. Safe pedestrian links are provided to access the existing linkage through Carnarvon Golf Course.
- O11. Appropriate levels of lighting are provided to all road and pedestrian linkages.

**Controls**

- C1. Pedestrian links shall not conflict with vehicular movements.
- C2. Access and facilities for the disabled and physically impaired shall be provided in accordance with provisions of the Disability Discrimination Act 1992 and Council's standards.
- C3. Road crossings shall be located where there is adequate sight distance and suitable lighting provided and to provide adequate safety for motorists, pedestrians, cyclists and disabled users.
- C4. Changes in surface finish shall be considered at road crossings, designated bus stops and intersections.
- C5. Where shared use of the street pavement is required, the design shall reflect that dual use to promote safety.
- C6. Cycle links shall be of sufficient width and profile for the purpose intended and where used in conjunction with pedestrian links the pathway should be widened at conflict points to allow safe passage of both pedestrians and cyclists.
- C7. Pedestrian facilities shall be consistent and continuous, and meet all the functional requirements for independent use by elderly and disabled users, including the vision impaired, wheelchair and electric scooter users.
- C8. Tactile ground indicator tiles shall be used at all road crossings, bus stops etc.

### 3.5 Site planning controls

This section sets out the objectives, performance criteria and development standards that relate to site planning and subdivision development.

#### Objective

- O1. The site planning and subdivision controls are to ensure that:
- interference with the topography is minimised;
  - the topography can be clearly read and understood;
  - the subdivision patterns set up regular rows of buildings and spaces and are suitable for the dwelling types;
  - a system of vehicular access to properties contributes to rather than dictates the resolution of the street; and
  - there are precincts/streets with a range of discrete characters

#### Controls

- C1. The street and block pattern shall:
- relate to the building types;
  - minimise cut and fill;
  - enable small increments of change between buildings;
  - enable the street hierarchy to be reinforced by the building types;
  - set up an appropriate spacing between buildings;
  - create a regular pattern of driveway access from the street;
  - provide views and vistas;
  - reinforce the qualities of the site; and
  - have the potential to provide external linkages over time.

#### 3.5.1 Setbacks

Setbacks are required to protect the privacy of adjoining residents, to provide for sunlight to adjoining dwellings and to provide a visual rhythm and coherence to the streetscape. Refer also to the subdivision and allotment planning controls diagrams in section 3.6.

#### Objectives

- O1. Ensure that the dwellings address the public domain and set up a spatial rhythm.
- O2. Ensure there is adequate solar access and privacy
- O3. The setbacks to the street need to provide:
- a clear reading of the topography;
  - a clear edge to the street and/or open space system;
  - a semi-private zone;
  - houses which are more dominant than garages;
  - reinforcement of the street hierarchy;
  - reinforcement of the street block where appropriate; and
  - an open streetscape with adequate areas for landscaping, fencing, and screen planting.
- O4. The setbacks to the side boundary and the rear are to ensure that there is:
- adequate solar access to neighbours;
  - privacy for residents and neighbours, and minimise overshadowing; and

- an even spatial rhythm along the street so that individual building types do not dominate.

**Controls**

- C1. Table 3 below sets out the minimum setback requirements for all dwelling types on the site.

*Table 3: minimum setback requirements for all dwelling types*

All dwelling types	
Primary front setback	4m to building façade of habitable rooms from the front boundary line. This setback may be reduced to 3m for dwellings fronting public open space or a corner, providing solar access and other environmental provisions are met.
Side and rear setback	A 1.2m side setback is required for 1 and 2 storey portions of dwellings.
	Garages, including those with studio accommodation above, in lanes can be located on the rear boundary provided a minimum of 7.5m is provided between the façade and opposite boundary fence or building façade. (Refer below for additional requirements).
Eaves/facias	825mm for 1 or 2 storey buildings.

- C2. Garages facing a street shall be set back a minimum of 5.5m from the front boundary.
- C3. Lots with rear vehicular access to the property can have a zero line setback at the rear where the minimum distance between building facades which contain habitable rooms with windows or another garage is 7.5m.
- C4. Two storey, open, non-habitable structures including carports, pergolas, verandahs and entry features shall sit within the 2m articulation zone as measured from the primary front setback.
- C5. Adjoining building facades shall be aligned. Building facades may vary in alignment only if a cohesive streetscape is achieved. Any variation to the alignment shall be derived from the building type and the topography, i.e. where a lot slopes away from an area of parkland or to achieve a more successful result by locating a building or group closer to the street edge.

3.5.2 Orientation

**Objectives**

- O1. Ensure that the orientation and organisation of lots will enable dwellings to achieve the environmental performance guidelines as set out in section 2 of this Part.
- O2. The building zone for the dwelling is predominantly at the front of the lot.
- O3. The higher density areas with smaller lot frontages are predominantly east-west or north-south where the north is at the rear.
- O4. Ensure the subdivision of allotments maximises the potential for energy efficient housing development whilst maintaining the design integrity of the overall development.

- O5. All allotments are to provide for sufficient area to allow the siting of dwellings and to allow for adequate areas of private open space, vehicle access and parking as set out elsewhere in this Part.

**Control**

- C1. Lots shall be oriented to facilitate the siting of dwellings to meet the Ecologically Sustainable Development (ESD) criteria set out in this Part.

The above requirements may be varied in cases where an applicant submits an integrated subdivision and development application demonstrating that the performance criteria have not been compromised.

3.5.3 Safety (CPTED) requirements

Applicants must refer to Council's Policy on *Crime Prevention Through Environmental Design, 2006*.

3.5.4 Private open space and landscaping

**Objective**

- O1. Private open space areas are to:
- relate to the living spaces, windows, access/egress points and function of the dwelling; and
  - be amenable and suitable for the intended use
- O2. All setback areas are to be landscaped to Council's satisfaction.
- O3. Ensure private open space is of a size and location suitable for the intended use.
- O4. Private open spaces and living areas are protected from overlooking from public and neighbouring areas.
- O5. Private open space areas are clearly defined and screened for private use.
- O6. Landscape treatment of private open space areas contribute to the master planned themes for streetscape and public open space (where private open space is visible from these public areas).
- O7. Landscape treatments complement solar access requirements for buildings.
- O8. Planting:
- is appropriate for its setting and environment;
  - is provided in the public and private domain;
  - complements the existing landscaping and topography, lighting and street furniture;
  - is simple and robust; and
  - provides privacy, screening and shading where required.
- O9. All new landscaping is to be designed to be low maintenance and low water usage.

**Controls**

- C1. New plantings shall contain endemic species that are of low maintenance and low water usage.
- C2. Cultural plantings shall be used where existing plantings are to be enhanced.
- C3. The minimum area of soft landscaping for residential development as a percentage of the total site area for each dwelling type shall be as set out in Table 4 below.
- C4. Private open space shall be of a minimum size as set out in Table 4 below and be able to contain a square measuring a minimum of 4m x 4m which is free from obstructions such as garden beds and steps.
- C5. Private open space areas associated with residences shall accommodate outdoor recreation needs and function as an extension of interior living areas.
- C6. Planting shall be used to minimise overlooking between dwellings, and between dwellings and public or common areas; having regard to crime prevention principles.
- C7. Planting shall be of appropriate mature heights and volumes to the space allotted to them.
- C8. The area between the front property boundary and the front building line shall not be considered as private open space unless solar access is principally to the front garden space and this area is suitably fenced and screened.

*Table 4: Minimum private open space per dwelling type*

	Detached	Semi-detached / zero lot line houses	Terrace houses & town houses
<u>Minimum area of private open space</u>	70m <sup>2</sup>	60m <sup>2</sup>	35m <sup>2</sup>
<u>Minimum landscaped area of site</u>	45%	40%	30%

3.5.5 Fencing

**Objectives**

- O1. Fencing is to:
  - clearly demark the public, semi-public and private domains;
  - complement the dwellings and the streetscape; and
  - provide privacy where appropriate.
- O2. All new dwellings to have side and rear boundary fences.
- O3. Front fences, where appropriate, contribute to the streetscape and allow gardens to contribute to the public domain
- O4. Front fences, where appropriate, extend alongside boundaries of corner sites back to the building line.

- O5. Ensure that rear and side fencing assists in providing privacy to private open space areas.
- O6. Fence height, location and design should not affect traffic sight distances at intersections.
- O7. Ensure that front fences relate in proportion to the height of the building and are appropriate to the style of residence

#### **Controls**

- C1. Side boundary fencing constructed behind the building alignment setback shall be a maximum height of 1.8m and be constructed from materials which complement the design of the dwelling.
- C2. The front and side dividing fences where located within the front yard area shall not exceed a height of 1.2m as measured above existing ground level and shall be a minimum of 50% transparent.
- C3. Front and side dividing fences where located within the front yard area shall not be constructed of solid pre-coated metal type materials such as colorbond or similar.
- C4. Front fencing that is to provide privacy screening for external living areas shall be considered up to a maximum height of 1.8m if complementary to the dwelling design.
- C5. Fencing to secondary road frontages and rear vehicular access shall be a maximum of 1.8m in height at the road boundary from the rear boundary up to the line of the front of the dwelling and must be of materials and design complementary to both the streetscape and dwelling.
- C6. Front fences shall be compatible with and sympathetic to the dwelling design.
- C7. Fencing styles shall complement both the architectural design of the dwelling and the streetscape. Front fences should not exceed 1.2m in height unless required for provision of privacy to private open space and unless appropriately screened by landscaping and with variations in materials and alignment.

#### **3.5.6 Ancillary site facilities**

Refer to Part B of this DCP.

#### **3.5.7 Site drainage and stormwater management**

The provision for and use of treated effluent is to be considered in housing development and public open space areas.

Stormwater runoff from the overall site should not occur at a rate greater than that which existed prior to site development works unless catered for in downstream control facilities and agreed by both the owner of the affected property and Council.

The conservation and re-use of stormwater is encouraged, but not so as to cause degradation of downstream waterway systems or result in economically unsustainable design alternatives. The system provided should ensure that there is no decline in the quality of stormwater leaving the site.

### **Objectives**

- O1. The drainage strategy takes into account a total catchment management approach such that downstream drainage systems are not impacted adversely through alteration to existing drainage flows from the site.
- O2. Drainage systems and ground surface areas are to be protected from pollutants and soil erosion. Pollutant and sediment control measures are required for all subdivision applications.
- O3. The drainage works for the site are to preserve the effectiveness of existing downstream flood mitigation and drainage works.
- O4. Proposed development is not to increase downstream flooding or increase pollutants on a total site performance basis. Off-site mitigation measures will be accepted as meeting this criteria subject to satisfactory arrangements with the affected landowner.
- O5. Stormwater infrastructure is to be designed to be aesthetically pleasing and landscaped so as to serve a dual function as a continuation of the open space and stormwater management.

### **Controls**

- C1. Stormwater shall be detained so that it is discharged from the site at rates not exceeding those at present and so there is no increase in the rate of flow in the catchments below the land to which this Part applies.
- C2. Stormwater shall be treated so that it is discharged from the site with a quality not less than the water quality of discharges at present and meeting all antecedent precipitation index (API) parameters for discharge of stormwater from new development sites up to 1 year ARI.
- C3. Stormwater shall be collected, conveyed and discharged for storms up to a 20 year ARI frequency, without flooding or unacceptable inconvenience.
- C4. Residential site drainage shall comply with the Part G of this DCP as well as additional site specific requirements provided below.
- C5. Soil and water management plans shall be submitted with all subdivision applications, and development activities shall be staged in a manner to suitably manage the effects of land disturbance.
- C6. Dual use of open space areas for drainage and stormwater management shall be encouraged as an efficient utilisation of land and shall be designed and constructed in accordance with appropriate standards relating to public safety and risk management.
- C7. The developer shall determine with Council appropriate operation procedures and designs including fences and other measures to ensure appropriate public safety relating to stormwater infrastructure (both dedicated to Council and in private ownership), particularly permanent water bodies.
- C8. Drainage facilities shall be of standard or other approved designs and supported by design calculations. Designs are to facilitate maintenance, cleaning and disposal of excess plant materials and other pollutants
- C9. Drainage systems shall be designed and constructed in accordance with the design guidelines set out in the most current version of Australian Rainfall and Runoff published



by the Institute of Engineers Australia. The adequacy of water quality systems shall be assessed by suitable modelling.

- C10. On-site detention (OSD) systems shall be designed in accordance with the requirements set out in Australian Rainfall and Runoff and Part G of this DCP.
- C11. Trapped sag points shall be avoided.
- C12. Permanent structures (i.e. dwellings, garages, impervious fencing etc.) shall not be constructed within the 1% Average Exceedance Probability (AEP) storm level or drainage flow path. Habitable rooms shall have a freeboard of 500mm above the flow surface unless otherwise justified. Garages and basement car parks shall be designed to prevent storm flows from entering. Larger floods shall not result in catastrophic impacts.
- C13. Site servicing and building design shall provide for maximum practical rain water use in the private and public domain. Alternatively, these needs may be serviced by the installation of a treated effluent reticulated system to Sydney Water's requirements.

### **3.6 Residential development and subdivision controls**

#### **3.6.1 Housing and private domain principles**

This section recognises that a range of densities is required to create a diverse built form that provides a wide choice of housing types.

A range of densities across the site is occurring and is further anticipated, and concentration of certain types is encouraged where it may be appropriate to create areas of distinct character where all other urban design, built form and housing controls can be met.

The private domain is to provide a high level of amenity to residents. The private domain includes private open space as well as the interface between private open space and dwelling interiors. Adequate solar access and privacy are fundamental qualities of the private domain.

To guide the built form and character of the private domain and to ensure that a high quality environment is created the following principles are to be met:

- a range of building types and densities are to be provided. This mix should include detached, semi-detached/zero lot line dwellings, town houses and terrace houses along with some studio accommodation above garages that are separate from the dwellings;
- buildings are to address the street and reinforce territorial definition;
- building design is to be responsive to, and integrated with, its environment and adjoining dwellings;
- building design is to be contemporary and be compatible in scale and proportion with the horizontal proportions of the heritage hospital buildings;
- the building design is to be energy efficient and may include eaves and other shading devices;
- building design is encouraged to link internal living and external courtyard/garden spaces;
- street facades and appearance are to be considered as part of overall streetscape design;
- building materials and finishes are to be durable; and
- private domain landscape is to contribute to the landscape masterplan for the site.

### 3.6.2 Housing objectives

#### **Objectives**

To ensure that residential development of land:

- O1. Creates a high level of residential amenity.
- O2. Ensures that individual housing design is integrated and sympathetic to the approved master plan and intended character of the area.
- O3. Ensures a distinctive architectural approach is adopted using a variety of housing types that incorporate strong contemporary roof forms and modulation, eave overhangs, as well as elements such as louvres that control and regulate the microclimate.
- O4. Promotes the building of dwellings that maximise the opportunity for energy efficient usage and solar access.
- O5. Provides residents with a high level of private amenity, particularly in relation to outlook and private open space.
- O6. Creates a socio-economically diverse residential community that is safe and convenient for residents.
- O7. Provides opportunities for social interaction, neighbourhood living, recreation, and cultural and environmental awareness.

*Note: the Master plan is a plan prepared by the applicant that accompanied the Stage 1 development application. It sets out the general principles relating to the development of the site in relation to the principal road network, open space areas and drainage infrastructure. The master plan is consistent with the principles and requirements of the Lidcombe Hospital Site Conservation Management Plan September 2002.*

### 3.6.3 Subdivision, allotment planning, size and shape

#### **Objectives**

- O1. Subdivision provides for a variety of housing types to meet a variety of housing needs including meeting the needs of the aged and people with a disability.
- O2. The allotment size and shape is adequate to contain the particular housing type, open space and car parking (with the required amenity).
- O3. The allotment size and shape sets up a regular subdivision pattern related to the particular dwelling type, the street hierarchy and the block and street pattern.
- O4. The allotment size and shape allows for buildings to align with the street system.
- O5. Where there are special conditions relating to landscape, topography, heritage, retention of existing buildings, that unique sized and shaped allotments are created.
- O6. Subdivision makes provision for dwelling houses and multi dwelling housing such as:
  - detached housing;
  - semi detached/zero lot line houses; and
  - terrace houses.

- O7. Individual allotments permit sufficient area commensurate with the dwelling type to allow for useable outdoor open space and solar access as required elsewhere in this Part.
- O8. The allotments and the location of the buildings are organised to set up regular patterns of buildings and space.
- O9. The allotments enable a range of housing types and spatial distribution.
- O10. The irregular shaped and sized allotments provide the opportunity for specific design solutions.
- O11. The allotments are predominantly rectangular.
- O12. The allotments which provide the higher density are located around the open space system.
- O13. The allotments are located so that the dwellings relate to the street hierarchy.

**Controls**

- C1. A street hierarchy shall be defined and related to housing types.
- C2. Level changes along a street block shall be made incrementally with minimal cut and fill.
- C3. Vehicular access ways at the rear of properties shall take advantage of level changes to increase the size of rear yard areas, and minimise cut and fill, and reflect the topography.
- C4. Housing types shall be built to a height of up to 3 storeys where it is necessary to define and balance the spatial system.
- C5. Minimum lot frontages for each of the dwelling types are set out in Table 5 below.

*Table 5: Minimum subdivision standards for individual dwelling types*

	Detached	Semi-detached /zero lot line houses	Terrace houses & town houses
Minimum frontage width at building line (m)	12*	7.5	6

\*may be reduced to 10m if the dwelling has a garage that is accessed from the rear of the property

- C6. Strata titling of studio accommodation shall be considered where the following outcomes are provided:
  - both the primary residence and the studio have individual frontage to a public road;
  - a minimum of 1 covered off-street car parking space is provided for the studio in addition to car parking required for the principal residence;
  - the studio accommodation has a minimum habitable floor area of 45sqm;
  - the studio accommodation has a balcony or private courtyard (designed to eliminate overlooking) of minimum 8sqm and a minimum depth of 2m;
  - the allotment on which the studio accommodation is located has a minimum width of 10m and a maximum area of 55sqm; and

- the privacy of the principal residence's rear yard and adjoining allotments is not compromised.

C7. Ensure subdivision and allotment planning for front and rear loading and multi dwellings are undertaken in accordance with Figures 3 and 4.

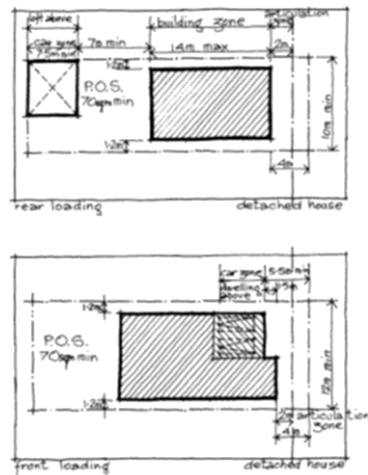

Figure 3: Subdivision and allotment planning control diagram – Front loading and rear loading.

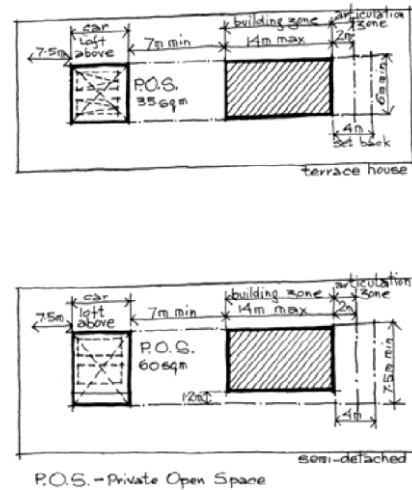

Figure 4: Subdivision and allotment planning control diagram – Multi dwellings.

### 3.6.4 Dwelling design and form

#### Objectives

- A range of dwelling types form a series of neighbourhoods, each having a distinctive character arising from the predominance of a particular dwelling type related to the street hierarchy, topography, heritage features and open space.
- Housing variation caters for a socio-economically diverse community.
- Ensure dwellings and garages are designed with regard to site conditions and minimise impact on landform.
- Ensure dwelling and garage design has regard to the amenity of adjoining development and surrounding properties.
- Ensure that dwellings built in the vicinity of heritage or retained buildings are designed so as not to detract from the significance or character of the heritage building or group of heritage buildings.
- Ensure that dwellings have a high level of internal and external amenity.
- Denser housing forms are to be located around open space and on wide verges.
- Dwelling groups are not composed of different dwelling types (e.g., terrace dwellings are to stand alone as one group).

- O9. Dwellings in the vicinity of heritage and/or retained buildings are to be sensitive to and compatible with such buildings and be designed so as to not detract from the significance or character of the heritage/retained building(s).
- O10. Taller or raised housing forms are to be located where land slopes away from an open space or across the width of the street.
- O11. Where land slopes along the street, dwellings to follow the slope of the land.
- O12. Floor to ceiling heights to enable good light penetration and cross ventilation.
- O13. Ensure that groupings of similar types of dwellings create areas of a particular identity in the built form and streetscape.
- O14. Ensure that dwelling design and types reinforce corners, the street, and open space hierarchy.
- O15. Dwellings and garages are designed with regard to the site conditions and minimise the impact on landform.
- O16. Ensure the majority of garages for dwellings are located off the primary street frontage and are accessed by a rear lane.

**Controls**

- C1. A minimum of 20% of the total number of dwellings shall be detached dwellings.
- C2. The building height controls and floor to ceiling controls applicable to buildings are set out in the Table 6, below.

*Table 6: Floor to ceiling heights*

	Levels	Minimum	Maximum
Dwellings	Ground floor	2.7m	3m
	1st and 2nd floor	2.4m	2.7m

- C3. Groupings shall comprise denser forms around parks, open space and wide verges.
- C4. The maximum building depth of any second or third storey components of dwellings shall be 14m.
- C5. Stairs, verandahs, entry features, courtyard walls, balconies, carports and porticos may encroach within the primary building line by not more than 2m provided the design, materials, colour and construction match the main dwelling.
- C6. Dwellings shall be predominantly 2 storeys with some component of single storey. 3 storey dwellings shall be considered if they are on sites where it can be demonstrated that it enhances the streetscape and/or legibility.
- C7. The floor level of any dwelling shall be a minimum of 500mm above the 1% AEP level of any adjacent drainage easement or water course or OSD facility.
- C8. Garage door openings fronting a public road shall be not be more than 5m wide or 50% of the frontage width of the allotment measured at the building alignment, whichever is the greater.

- C9. Garage door fronts shall be setback a minimum of 5.5m from the street boundary and 1.5m back from the front dwelling façade.
- C10. A minimum of 30% of dwellings shall have garage access from the rear of the allotment.
- C11. Rear access shall be organised to optimise the street character and to limit the number of garage doors facing the street frontage.
- C12. Garages, particularly doors, carports and parking areas shall be detailed to reduce their visual impact and add interest at ground level. The materials used in the garage shall complement those of the house.
- C13. Garage and carport design shall be in the same application as the dwelling even if it is to be constructed at a later date.
- C14. Carports shall be designed so that secondary elements do not dominate the dwelling façade.
- C15. Pitched roofs to carports shall not permitted unless compliance with the streetscape objectives can be demonstrated and the carport structure does not dominate the dwelling façade.
- C16. Carports shall be a maximum of 3.5m in width.
- C17. Carports shall be designed as open pergola type structures. This may include a flat roof and shall not be screened on the sides or front.
- C18. Carport structures shall be setback a minimum of 2m from a primary street front boundary.
- C19. Carport structures shall not exceed 3.5m in height including all elements.

### 3.6.5 Density of dwellings

#### **Objectives**

- O1. Ensure that the amount of development over the whole site is to enable a successful resolution between the new development, the heritage buildings and the public domain including open space.
- O2. The highest density housing forms are located around the open spaces.
- O3. Density is to be optimised while allowing for:
  - adequate open space;
  - appropriate curtilage for heritage and retained buildings;
  - appropriate curtilage for landscape of exceptional and high value;
  - a street and block system which suits the building typologies and enables the reading of the landscape setting; and
  - minimum intrusion on the topography.

### 3.6.6 Site coverage

#### **Objectives**

- O1. Site coverage enables the proposed building type, adequate open space and the required car parking.

O2. Site coverage varies to suit the dwelling type i.e. terrace houses require greater site coverage than detached houses.

O3. Development achieves:

- a clear physical (bulk) relationship between each building type and its allotment size with regard to creating neighbourhoods of some homogeneity; and
- adequate separation between dwellings particularly at the rear of the site.

**Control**

C1. The maximum site coverage for residential development as a percentage of the total site area for each dwelling type shall be as per the table below:

*Table 7: Maximum site coverage*

	Detached	Semi detached/ zero lot line houses	Terrace houses and townhouses
Maximum site coverage	55%	60%	70%

3.6.7 Composition within street blocks and along streets

**Objectives**

O1. Ensure that the organisation of the dwellings within the street block relate to the street and open space hierarchy and desired future character of the precinct.

O2. Overall the composition within the residential street blocks is arranged so that:

- the street hierarchy is reinforced;
- the characteristics of the topography and landscaping are revealed;
- there is a setting for the dwellings;
- there is a public realm of high quality;
- view corridors are reinforced;
- views and vistas between dwellings are provided where appropriate;
- competing requirements for rear access, building type, streetscape and street hierarchy are balanced;
- the composition of lanes within street blocks sets up the response required for the housing to the street;
- the number of any particular housing type within a block responds to the street composition;
- building types on opposite sides of the street are of a similar type so that precincts and streets have a consistent character;
- for parks and vegetated areas that slope from one side to the other, housing fronting the low side of that slope is to be generally higher than the housing on the high side. Thus better defining the spatial volume of the park and street;
- vehicular access ways at the rear of properties can be open (permitted security gates) at both end; and
- rear vehicular access ways, streets and dwellings are located as closely as possible to the natural contours.



**Control**

C1. Dwellings shall be organised so that:

- denser dwelling forms are to be located around open space and wide streets;
- high house forms are located on the main entrance park way;
- the spacing between different types of dwellings is to be regular and related to topography, length of street block and potential view corridors; and
- the qualities of the topography and spatial organisation are balanced by the built form.

See Figure 5 below.

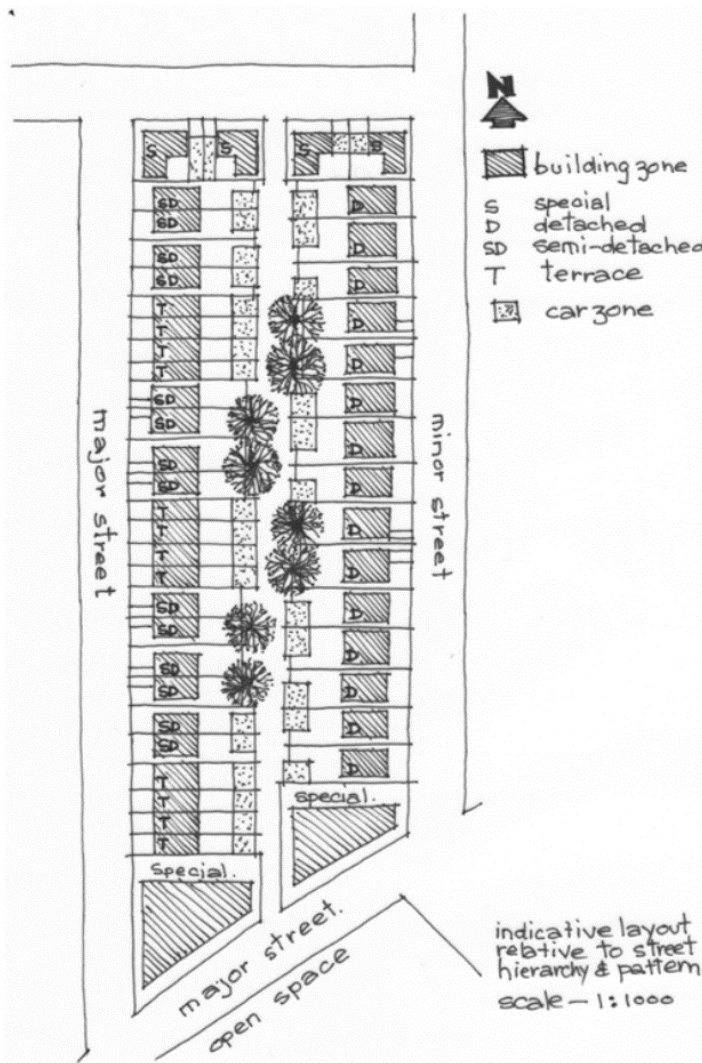

Figure 5: Composition within street blocks

3.6.8 Architectural Expression

**Objectives**

O1. Ensure that dwellings relate well to one another and contribute to the quality of each precinct and the overall quality of the development.



- O2. The architectural expression of dwellings is to ensure that:
- attached housing has clearly defined party walls which enable buildings to adjust to the topography without large benching;
  - roof forms in attached housing are to reflect the stepped changes at ground level;
  - a high standard of architectural design of both individual dwellings and groups of dwellings;
  - special design responds to unusual block shapes such as corner lots, non rectangular lots, and heritage buildings;
  - special urban design features are reinforced such as the alignment of roads which curve towards a spatial gateway or landscape focus;
  - building entries are clear and legible;
  - windows, facades and rooms are well proportioned;
  - materials and detailing are appropriately used;
  - roof forms are used which relate to the definition of space and do not create big buildings such as hip roofs on runs up terrace houses are not appropriate;
  - attention to both the building base and roof is required;
  - roof forms in attached housing reflect the stepped changes at ground level;
  - windows to main rooms are directed to the front and rear
  - the head height of windows relate to the height of the ceiling; and
  - there is variety but continuity between dwellings.

### Controls

- C1. Design of dwellings shall consider the following:
- Articulation of building facade using:
    - material and detailing;
    - legible building entrances;
    - balcony and other elements; and
    - well proportioned openings, window, type and size.
  - corner buildings shall be articulated to reinforce the corner condition by addressing both street frontages;
  - building elements such as balconies, verandahs, pergolas, sun shading, porches and other elements shall be used to articulate the façade;
  - windows to living areas shall be directed either to the street or rear private open space (and vehicular access ways) to provide surveillance to the street and other open space areas;
  - modulation of the facade shall be integral to the design of the building, its setting and not arbitrary;
  - level changes along a street block shall be made incremental with minimal cut and fill; and
  - vehicular access ways to the rear of properties shall take advantage of level changes to increase the area of the rear yard area, minimise cut and fill and reflect the topography. Refer to Figure 6 and 7 below.
- C2. Windows and doors, particularly those that face the street, shall be provided in a balanced manner and respond to the orientation and internal uses.
- C3. Roofs shall be pitched between 20 and 40 degrees with well resolved junctions. Refer to Figure 6 and 7 below.

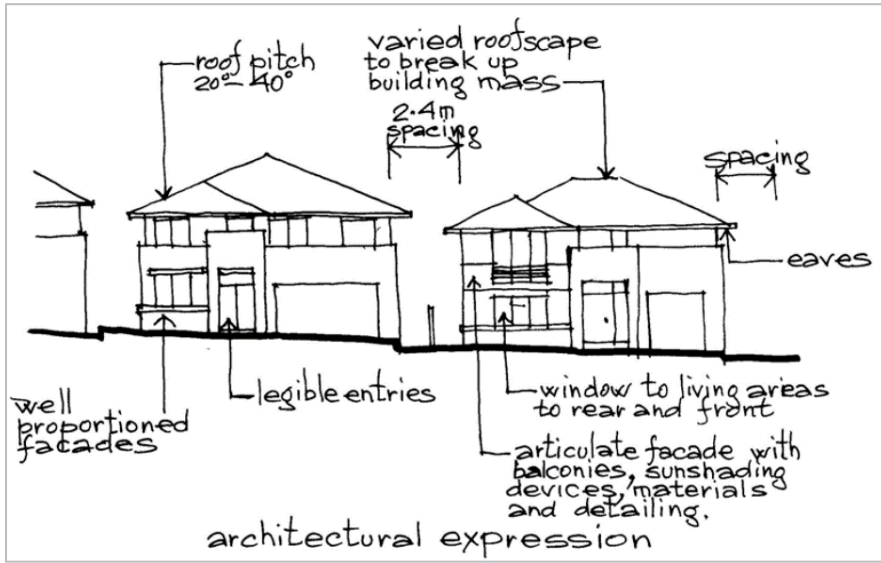

Figure 6: Forms of architectural expression

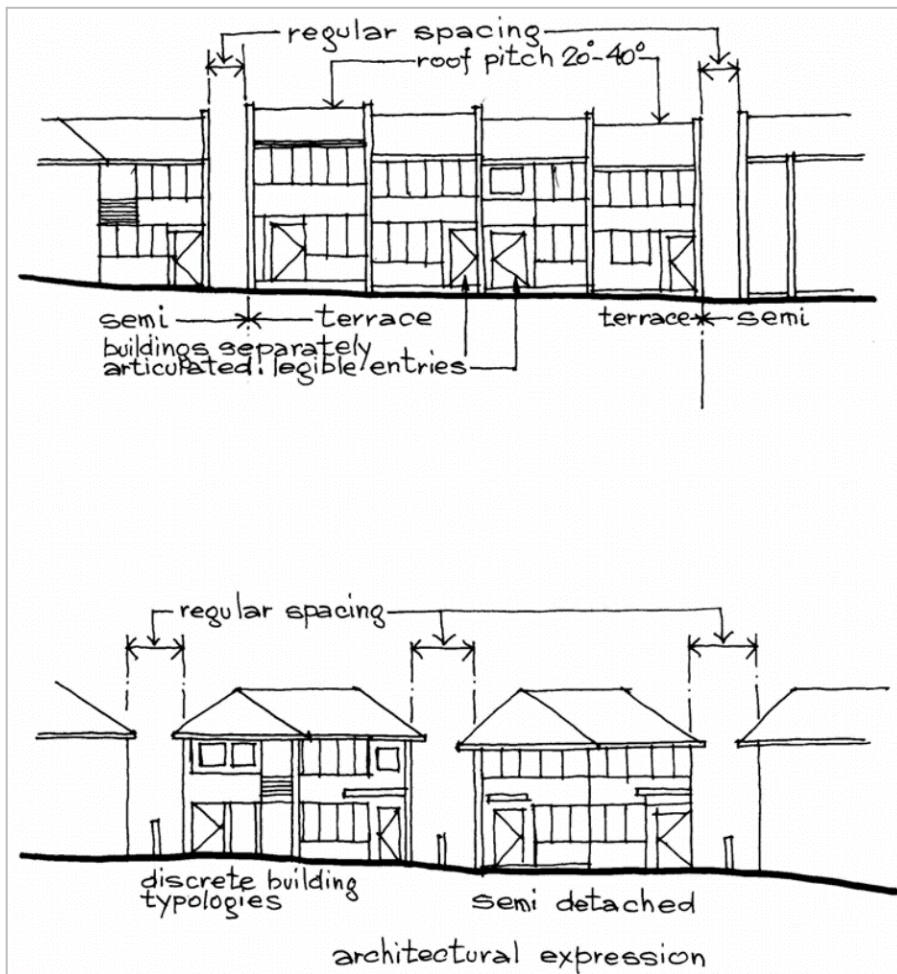

Figure 7: Forms of architectural expression

### 3.6.9 Adaptable housing

#### **Objectives**

- O1. Ensure a sufficient proportion of dwellings include accessible layouts and features to accommodate changing environments of residents.
- O2. Development to allow for dwelling adaptation that meet the changing needs of people's lifestyle.

#### **Controls**

- C4. A minimum of 10% of the total number of dwellings shall be constructed so as to be adaptable for use by aged or disabled occupants in accordance with the relevant provisions of the *Building Code of Australia* and Australian Standards.
- C5. Refer to the requirements for adaptable housing in Part B of this DCP.

### 3.6.10 Building materials

#### **Objectives**

- O1. Ensure that materials are durable and have a long life.
- O2. Ensure that materials have low embodied energy.
- O3. Ensure that materials contribute to the design of the buildings in terms of aesthetics and comfort.
- O4. Materials are to:
  - create a high quality finish which is robust over time;
  - be appropriate to the scale and detailing of the building;
  - relate well to one another;
  - respond to the heritage buildings on the site; and
  - provide thermally responsive dwellings.

#### **Controls**

##### Walls

- C1. Exterior walls shall be predominantly masonry and/or timber. Lightweight materials especially timber can be used to add interest and texture to the building and to break up larger expanses of wall.
- C2. Bolder brighter shades for areas of detail shall be appropriate provided that these are in keeping with the overall colour scheme of the house and do not detract from the general harmony of the street.

##### Roofs

- C3. Single colour tile roofs are preferred. Pre-finished metal sheeting may be used on concealed roofs or "lean to" construction.
- C4. Colours shall reinforce the character of the precinct.

### Windows

- C5. Windows may be constructed of timber or pre-finished aluminium and shall be in a dark colour.

### 3.6.11 Solar amenity

#### **Objectives**

- O1. Ensure that housing design is energy efficient, assists in developing ecologically sustainable residential communities and leads to a reduction in the household use of fossil fuels.
- O2. The design of buildings minimises household energy needs, utilises passive solar design principles and ensures adequate solar access.
- O3. Shading to western walls is to be provided where not overshadowed by adjoining walls or vegetation.
- O4. Roof insulation is incorporated into all residential development.
- O5. All dwellings have high levels of light penetration.
- O6. Cross ventilation is provided.
- O7. Buildings are to be designed with windows that are located, sized and/or shaded (including the use of eaves) to facilitate thermal performance and minimise the use of artificial light during daylight hours.
- O8. The design of residential dwellings is to demonstrate passive design principles including:
- window placement;
  - building orientation;
  - shading;
  - insulation;
  - ventilation; and
  - sensitive landscaping.

#### **Controls**

- C1. The use of materials shall minimise energy use over their whole lifecycle.
- C2. All residential buildings, where not affected by external noise sources, shall be able to be operated in a naturally ventilated mode and achieve comfortable internal conditions.
- C3. Vegetation shall be used to cool the ambient temperature within the development. Selective use of trees shall include consideration of deciduous trees to provide shading in summer and allow passive heat in winter.
- C4. Buildings shall be designed to allow passive heating in winter. Selective shading shall be applied so that the high angles of sunlight in summer do not penetrate the buildings.
- C5. Distances between buildings shall be designed to allow natural light to dwelling living spaces.

### 3.6.12 Privacy and overshadowing

#### **Objectives**

- O1. Ensure the design of buildings and position of windows respects the privacy of adjoining residents.
- O2. Buildings are to be sited and designed to ensure provision of daylight to habitable rooms in adjacent dwellings and neighbouring open space including the private open space associated with dwellings.
- O3. Buildings are to be designed to ensure appropriate levels of privacy.
- O4. Developments are to include site planning, building design and landscaping that minimises the overshadowing of adjoining properties.

#### **Controls**

- C1. Windows to living areas shall face predominantly to the street and to the rear.
- C2. Windows to living areas that face directly on to windows, balconies or private open space of adjoining properties shall be appropriately screened and/or have reasonable separation. A distance of 9m between openings of separate dwellings is required unless other mitigating measures are adopted.
- C3. First floor balconies shall not be permitted where directly overlooking living areas of adjacent dwellings unless suitable screening is provided.
- C4. At least 50% of the ground level private open space shall receive not less than 3 hours of sunlight between 9:00am and 3:00pm on June 21 for a minimum of 80% of all dwellings.
- C5. At least one internal living area shall have access to a minimum of 3 hours of direct sunlight between the hours of 9:00am and 3:00pm on June 21. This shall be achieved for a minimum of 80% of all dwellings.

### **3.7 Waste controls**

Applicants must refer to the waste requirements held in Part G of this DCP.

### **3.8 Parking and loading controls**

Applicants must refer to the parking requirements held in Part G of this DCP.

This page has been left intentionally blank.



CUMBERLAND  
CITY COUNCIL

# **PART F1-8 GARY STREET, MERRYLANDS**

This page has been left intentionally blank.



# 1. Introduction

## Proposed development and subdivision of Gary Street

This section provides a guideline for the creation of a cul-de-sac at the eastern end of Gary Street, Merrylands.

# 2. Specific objectives and controls

## Objective

- O1. Ensure the creation of a cul-de-sac occurs at the time redevelopment occurs on the subject land.

## Control

- C1. Redevelopment of the properties identified in bold outline below requires the dedication of land for the purpose of creating a cul-de-sac in accordance with the plan.

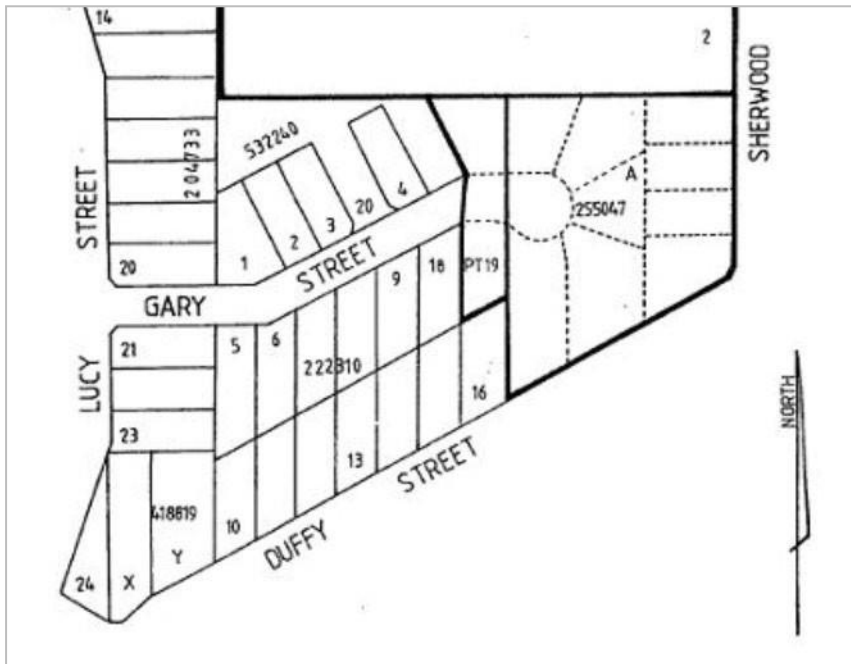

Figure 1: Gary Street Subdivision

This page has been left intentionally blank.



CUMBERLAND  
CITY COUNCIL

# PART F1-9 GREYSTANES CREEK

This page has been left intentionally blank.

# 1. Introduction

## 1.1 Land to which this Part applies

This section applies to land situated in Cumberland City outlined in heavy black as shown on the plan map marked Figure 1. A list of the properties subject to this plan is contained in Appendix A.

All sections of the Plan shall apply when affected properties are developed for multiunit dwellings or are subdivided. For other forms of development the “Setback” and “Drainage” sections shall apply.

# 2. Vision and general objectives

## 2.1 Context

In early 1993, a portion of Greystanes Creek between Oklahoma Avenue/Memphis Crescent and Octavia Road, Toongabbie was realigned as part of flood mitigation works, and a program of regeneration to re-establish the native vegetation was commenced prior to the formation of Cumberland City Council.

A Plan of Management (POM) for Greystanes Creek Reserve has also been prepared, which outlines future management strategies and works which will enhance the Reserve’s value for recreation, wildlife habitat, nature conservation, water quality improvement, drainage, and flood mitigation. Private property adjacent to the Greystanes Creek Reserve will play a vital role in supporting these works, and this section of the DCP aims to ensure that new development is compatible with the aims of the POM.

## 2.2 Aims

The purpose of this section of the DCP is to provide guidelines that will ensure development on land adjacent to Greystanes Creek Reserve is compatible with the Greystanes Creek Reserve Plan of Management by:

- extending the potential for a wildlife corridor by re-establishing the native bushland vegetation of the creek environment on land adjacent to the Reserve;
- enhancing the visual appeal, landscape characteristic and scenic quality of the Reserve;
- providing a visual buffer between the Reserve and development on land adjacent to the Reserve; and
- limiting sediment and nutrient run-off through the establishment of a vegetated buffer between new development and Greystanes Creek Reserve.

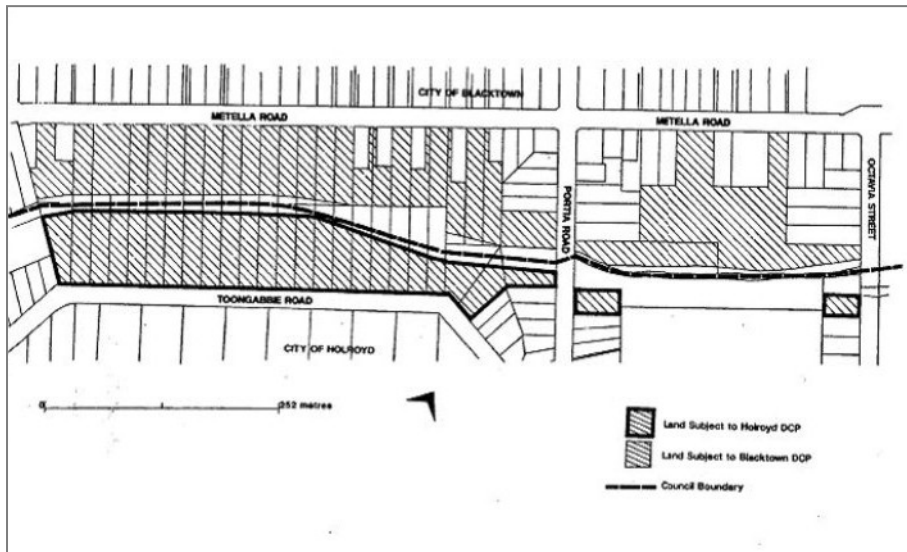

Figure 1: Greystanes Creek

### 3. Specific objectives and controls

#### 3.1 Setback

##### Objectives

- O1. Ensure the potential for a wildlife corridor onto land adjacent to the Reserve.
- O2. Ensure a visual buffer is provided between the Reserve and development on adjacent land.

##### Controls

- C1. All buildings and structures shall be set back 10m from the boundary adjacent to the Greystanes Creek Reserve. Buildings and hard surfaces shall not be permitted within this 10m zone. This zone will constitute part of the overall landscaped area of the development.
- C2. The 10m setback has been derived from the expected size of the tree canopy for those tree species indigenous to the area. This will permit the planting of trees close to the property boundary adjacent to Greystanes Creek.
- C3. Reserve with the reduced likelihood of tree roots interfering with buildings or utilities when the trees mature. The tree canopy will also not extend over the roof of any buildings, which could be a matter of concern.
- C4. Consideration will be given to setbacks of less than 10m on those blocks that have a side boundary with the reserve.

#### 3.2 Fences

##### Objectives

- O1. Ensure there is a minimal physical barrier to the extension of the wildlife corridor from the Reserve onto adjacent land.

- O2. Ensure there is a minimal visual barrier between the Reserve and development on adjacent land.

**Controls**

- C1. Fencing of property along boundaries with the Greystanes Creek Reserve shall have a maximum height of 1.8m and be of an open pool type construction.
- C2. The fencing is to be of a dull metallic finish and of a colour that blends with the natural bushland environs. This type of fencing will extend the potential for a wildlife corridor by removing the physical barrier between plantings on the Reserve and adjacent land. The open fencing will enhance the scenic quality of the Reserve through the visual integration of the Reserve and adjacent land and increase safety by providing improved visibility.

### **3.3 Landscaping and site design**

**Objectives**

- O1. Extend the potential for a wildlife corridor by re-establishing the native bushland environment on land adjacent to the Reserve.
- O2. Enhance the visual appeal, landscape characteristic and scenic quality of the Reserve.
- O3. Provide for shade and acoustic and visual privacy on land adjacent to the Reserve.

**Controls**

Retention of native vegetation

- C1. There shall be no removal of local endemic trees or understorey vegetation, other than noxious weeds, within the proposed 10m buffer.
- C2. All plans for development must ensure that local endemic plant species are retained and protected.
- C3. Vegetation to be retained is to be protected from damage during construction works, such as the compaction of soil and damage to root systems.
- C4. Council's Tree Management Order forbids the removal or lopping of any tree without Council consent.

Vegetation

- C5. Council shall require that all vegetation planted in the landscaped area are plants commonly found in the area, as per Appendix A. A list of specialist nurseries is available from Council.
- C6. Developers will be required to submit landscape plans with the Development Application.
- C7. The details of the proposed landscaping are to be prepared by a suitably qualified person acceptable to Council.
- C8. Council requires that a landscape bond be lodged on the basis of the value of the proposed development. The bond is to be retained for a minimum period of 12 months

after the completion of development to ensure that landscaping works have been undertaken, are successful, and have been satisfactorily maintained.

Landscape works

- C9. Within the 10m buffer zone landscape works shall be undertaken in accordance with this plan so as to re-establish local bushland vegetation.
- C10. The landscape works shall consist of a garden bed located adjacent to the boundary fence (Refer to Figure 2).
- C11. The garden bed shall have a minimum width of 2.5m, be planted only with those endemic plant species listed in the Species List and include trees, shrubs and groundcover.
- C12. The planting shall be of sufficient density to replicate a natural bushland ecosystem. The aim is to provide habitat for native wildlife, such as birds, invertebrates and insects.
- C13. The following density of plantings are given as a guideline:

Planting Densities:

- Trees: 1 per 4-5 m<sup>2</sup>;
- Shrubs: 2 per 1m<sup>2</sup>; and
- Ground cover: 4-8per m<sup>2</sup>.



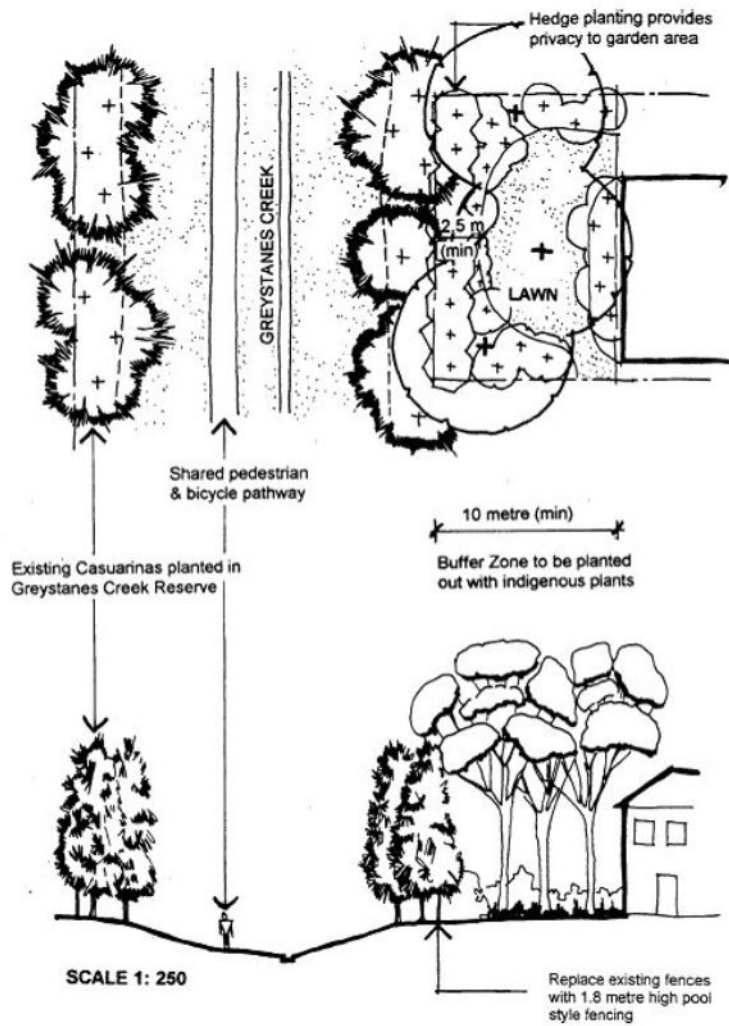

**Figure 2.** Landscape treatment for new development adjacent to Greystanes Creek Reserve.

*Figure 2: Landscape treatments*

### 3.4 Drainage

#### Objectives

- O1. Ensure the amount of urban run-off pollutants to Greystanes Creek is as minimal as possible.
- O2. Ensure adequate control erosion measures are taken.

#### Controls

- C1. Appropriate erosion and sedimentation controls shall be undertaken in accordance with Council's *Erosion and Sedimentation Control Policy* to the satisfaction of Council's Building Surveyor.

- C2. Measures to minimise nutrients and sediment entering Greystanes Creek shall be undertaken through the establishment of a vegetated buffer between the development and Greystanes Creek.

### **3.5 Fire**

#### **Objectives**

- O1. Ensure the potential for bushfire risk on the Reserve and adjacent land is as minimal as possible.

#### **Controls**

- C3. It is recommended that fuel reduction measures are undertaken on land adjacent to the Reserve.
- C2. Measures include the provision of leaf guards to gutters. Within the Greystanes Creek Reserve itself, the creek and drainage channels form natural fire breaks, which, combined with fragmented and isolated nature of the vegetation, means that major fire events are unlikely to occur.

## **4. Appendix A – Greystanes Creek**

### **Land within the Greystanes Creek Precinct**

DP 837421 Lot 41 139 Toongabbie Road, Toongabbie  
DP 837421 Lot 40 137 Toongabbie Road, Toongabbie  
DP 837421 Lot 39 135 Toongabbie Road, Toongabbie  
DP 837421 Lot 38 133 Toongabbie Road, Toongabbie  
DP 837421 Lot 37 131 Toongabbie Road, Toongabbie  
DP 837421 Lot 36 129 Toongabbie Road, Toongabbie  
DP 837421 Lot 35 127 Toongabbie Road, Toongabbie  
DP 837421 Lot 34 125 Toongabbie Road, Toongabbie  
DP 837421 Lot 33 123 Toongabbie Road, Toongabbie  
DP 837421 Lot 32 121 Toongabbie Road, Toongabbie  
DP 837421 Lot 31 119 Toongabbie Road, Toongabbie  
DP 837421 Lot 30 117 Toongabbie Road, Toongabbie  
DP 837421 Lot 29 115 Toongabbie Road, Toongabbie  
DP 837421 Lot 28 113 Toongabbie Road, Toongabbie  
DP 837421 Lot 27 111 Toongabbie Road, Toongabbie  
DP 837421 Lot 26 109 Toongabbie Road, Toongabbie  
DP 837421 Lot 25 107 Toongabbie Road, Toongabbie  
DP 837421 Lot 24 105 Toongabbie Road, Toongabbie

DP 837421 Lot 16 103 Toongabbie Road, Toongabbie

DP 837421 Lot 18 101 Toongabbie Road, Toongabbie

DP 837421 Lot 23 99 Toongabbie Road, Toongabbie

DP 837421 Lot 22 97 Toongabbie Road, Toongabbie

DP 837421 Lot 21 95 Toongabbie Road, Toongabbie

DP 617512 Lot 1 26 Portia Road, Toongabbie

DP 11508 Lot 206 29 Portia Road, Toongabbie

DP 11508 Lot 181 18 Portia Road, Toongabbie

This page has been left intentionally blank.



CUMBERLAND  
CITY COUNCIL

# PART F1-10 GUILDFORD PIPEHEAD PRECINCT

This page has been left intentionally blank.

# 1. Introduction

## 1.1 Land to which this Part applies

This part applies to the land shown on Figure 1 and known as the Guildford Pipehead Precinct.

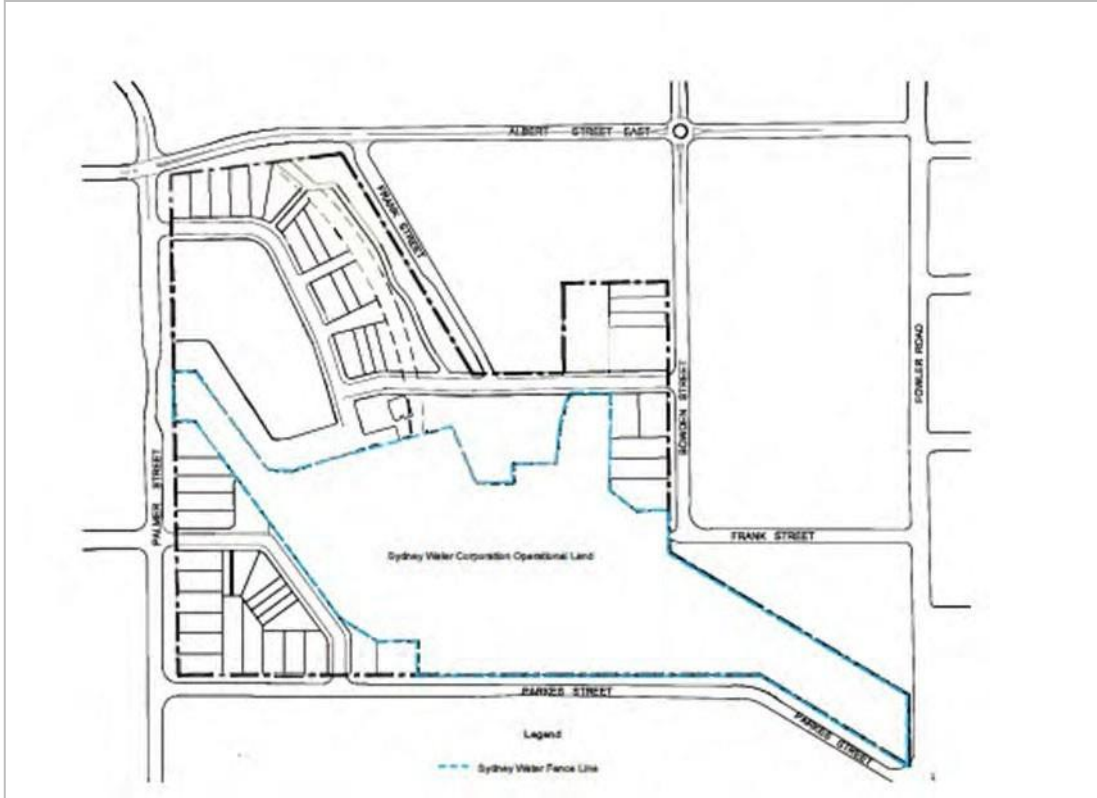

Figure 1: Guildford Pipehead precinct map

## 1.2 Relationship to other Parts of this DCP

Part F of the DCP shall be read in conjunction with the following Parts of *Cumberland DCP 2021*, which contain objectives and development controls that may relate to development in this part:

- Part B – Development in the Residential Zones;
- Part C – Development in the Business Zones;
- Part E - Other Land Use Based Development Controls; and
- Part G – Miscellaneous Development Controls.

## 2. Vision and general objectives

### 2.1 Objectives

- O1. Facilitate the appropriate reuse of lands within the Guildford Pipehead Precinct that is surplus to current Government needs.
- O2. Conserve and enhance the heritage significance of the Guildford Pipehead Precinct.
- O3. Protect and conserve the natural heritage features of the Precinct and allow historic interpretation of the Guildford Pipehead Precinct.
- O4. Only permit development that is reflective and sympathetic to the historic nature of the Guildford Pipehead Precinct and the character of the area surrounding it.
- O5. Ensure that development on the perimeter of the precinct is compatible in character and scale with the surrounding residential area.
- O6. Mitigate the impact of the change in land use with respect to the security needs of the operational Pipehead site.
- O7. Provide for the conservation of and public access to:
  - Land with significant natural heritage or conservation values; and
  - That part of the Lower Prospect Canal outside the operational Pipehead site.

### 2.2 Sub-Precincts

For the purposes of this Part of the DCP, the Guildford Pipehead Precinct is divided into the three sub-precincts, as indicated on Figure 2, whose character is described below.

#### Sub-Precinct A

- having an approximate area of 24,011m<sup>2</sup>;
- bounded by Palmer, Albert and Frank Street;
- includes State heritage listed canal and significant heritage landscape plantings;
- land is generally flat, with several steep embankments;
- contains existing industrial sheds, from sites former use;
- provides vistas to Prospect Hill, Blue Mountains and Holsworthy;
- partial interface with low density, detached dwellings; and
- sub-Precinct A allows permeable views to Sydney Water site.

#### Sub-Precinct B

- approximate area of 17,842m<sup>2</sup>;
- frontage to Bowden Street;
- contains significant plantings, predominant woodland character;
- existing cycleway access is located within Sub-Precinct; and
- contains a number of steep slopes.

#### Sub-Precinct C

- approximate area of 13,600m<sup>2</sup>;
- located at the intersection of Palmer and Parkes Streets;
- separated from SWC land by existing pipeline;
- land is generally flat, although sloping along Parkes Street; and
- interface with existing low density, detached dwellings.



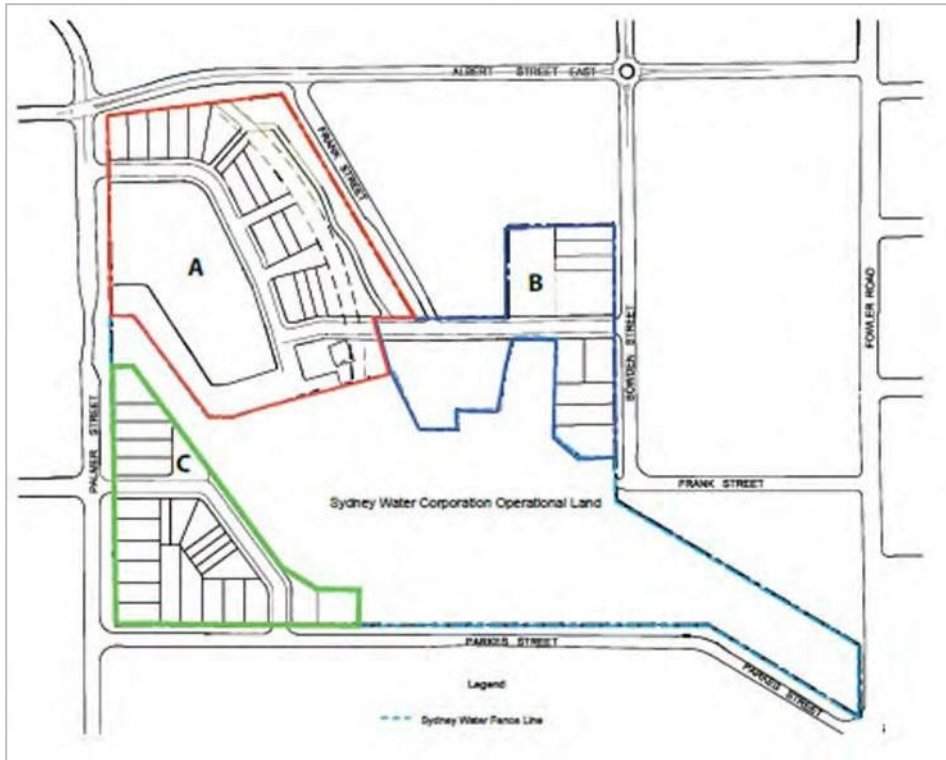

Figure 2: Sub-Precincts map

### 3. Specific Objectives and Controls

#### 3.1 Urban Design

##### Objectives

- O1. Provide passive surveillance to the Sydney Water operational land through road and lot layout to allow visual connectivity and security.
- O2. Interpret key historic themes and heritage values of the site through urban design and built form.
- O3. Conserve existing significant vegetation.
- O4. Allow the provision of a network of well located and usable open spaces.
- O5. Provide a range of housing types that integrate with the existing built interface and landscape features.

##### Controls

- C1. Create an east/ west link through the site to provide physical and visual connectivity.
- C2. Create connections with the established residential area of Guildford West.
- C3. Maximise pedestrian access and visual connectivity to the existing canal.
- C4. Integrate new housing with housing forms in the existing area.

- C5. Locate higher density housing types having regard for topography and significant visual corridors of the precinct.
- C6. Facilitate pedestrian and vehicular access that allows connectivity within precinct.
- C7. Design development to retain, as far as possible, the natural heritage features of the precinct.
- C8. Maintain the landscape character of the precinct.

## 3.2 Lot Structure

### Objectives

- O1. Integrate new development with established development within the Guildford West area.
- O2. Ensure all lots have a street address and enforce the street edge.
- O3. Allow visual connectivity into and within the precinct.
- O4. Create lot structures to ensure development maintains significant visual corridors.
- O5. Ensure sustainable development through lot orientation.
- O6. Ensure active surveillance of all public spaces.

### Controls

- C1. All lots shall have a primary frontage addressing a street.
- C2. No battleaxe lots are to be created within the precinct.

*Note: Refer to Figure 6.*

#### Sub-Precinct A

- C3. Lots located north of New Road 1 in Sub-Precinct A shall have a primary frontage to New Road 1 and a secondary frontage to Albert Street East.
- C4. Lots located between New Road 1 and the Lower Canal in Sub-Precinct A shall have a primary frontage to New Road 1 or New Road 4.

#### Sub-Precinct B

- C5. Lots in Sub-Precinct B shall have frontage to Bowden Street.
- C6. Where possible, lots in Sub-Precinct B shall have a secondary frontage to New Road 1.
- C7. Internal lots shall have frontage to New Road 1.

#### Sub-Precinct C

- C8. Lots in Sub-Precinct C shall have frontage to either Palmer or Parkes Streets, or New Road 2.
- C9. Lots Sub-Precinct C may have a secondary frontage to New Road 2.

### 3.3 Built form

#### Objectives

- O1. Ensure that building heights have regard for the heritage values of the Precinct, the topography and significant visual corridors of the Precinct and the character of the surrounding residential area.
- O2. Ensure development is setback from internal and external roads and the Lower Canal so that the open appearance of the precinct is maintained.
- O3. Allow row housing and zero-lot-line detached houses to be erected within the Precinct.
- O4. Maintain existing views to, from and through the precinct.
- O5. Ensure that the built form of the Precinct responds to existing vegetation and heritage items, including those on the Sydney Water operational land, and the surrounding built environment.

#### Controls

##### Building orientation and articulation

- C1. All buildings shall address the relevant lots primary frontage to an existing or new road (or both) with appropriate articulation to provide interest to the public domain.

##### Building height

*Note: The maximum permissible height (in metres) is detailed within Cumberland Local Environmental Plan 2021, as a written statement and associated maps.*

- C2. The maximum height of buildings, in storeys, within the Guildford Pipehead Precinct shall be:

*Table 1: Maximum height of buildings (storeys)*

Building type	No. of storeys
Detached and Attached Housing	2
Multi Dwelling Housing	2
Residential Flat Building	4

- C3. Notwithstanding C1, Council may permit 3-storey multi dwelling housing:
  - within Sub-Precinct A, south and west of New Road 1; and
  - within Sub-Precinct B, south of New Road 1 immediately east of the Community Park

##### Setbacks

- C4. Buildings within Sub-Precinct A shall be setback from streets, side and rear boundaries in accordance with the requirements of Part B of this DCP but with the following exceptions (as shown on Figure 3):
  - 15m from Palmer Street, between the Sydney Water operational land and New Road 1;
  - 5m from the Lower Canal.

- C5. Buildings within Sub-Precincts B and C shall be setback from streets, side and rear boundaries in accordance with the requirements of Part B of the DCP, except where specified under C4 above.
- C6. Despite the requirements of Part B of the DCP, except where the relevant lot boundary is also the boundary of the Guildford Pipehead Precinct:
- row houses forming part of multi dwelling housing may be constructed with no setback to a side lot boundary; and
  - detached houses on lots less than 450m<sup>2</sup> may be constructed on one lot boundary.

#### View corridors

- C7. The view corridors identified on Figure 3 shall be a minimum of 10m in width and be free of all buildings and structures, except:
- access ramps;
  - barbeques;
  - children's play equipment;
  - clothes lines and hoists;
  - driveways, paths and paving;
  - fences less than 1.8m in height;
  - on-site detention tanks and basins below finished ground level;
  - rainwater tanks below finished ground level; and
  - water features and ponds.
- C8. Landscaping within the view corridors shall not include species greater than 1.8m in height at maturity.

#### Building form and materials

- C9. Buildings shall respond to existing vegetation and heritage items, including those on the Sydney Water operational land, and the surrounding built environment through the use of:
- dark tones of brick sympathetic to the dark tones of the existing landscape;
  - light tones for metal roofs;
  - low pitched roofs and generous eaves; and
  - natural or painted timber detail to complement the dark shades of existing vegetation.
- C10. Apartment buildings are to incorporate:
- articulated facades to add character to the public domain and streetscape; and
  - split face block structure or panels including the use of metal sheeting elements to reflect the former industrial heritage of the site.
- C11. Gable and hipped roofs are to have a pitch of 20 – 30 degrees, to match that of existing Building 25, while skillion roofs are to have a pitch of 10 degrees.

#### Sub-Precinct A

- C12. Housing within Sub-Precinct A should include a mixture of residential flat buildings, multi dwelling housing, attached housing and detached housing on small lots.

#### Sub-Precinct B

- C13. Housing within Sub-Precinct B should include a mixture of residential flat buildings, multi dwelling housing, attached housing and detached houses.

Sub-Precinct C

- C14. Housing within Sub-Precinct C should include a mixture of multi dwelling housing, attached housing and detached houses.

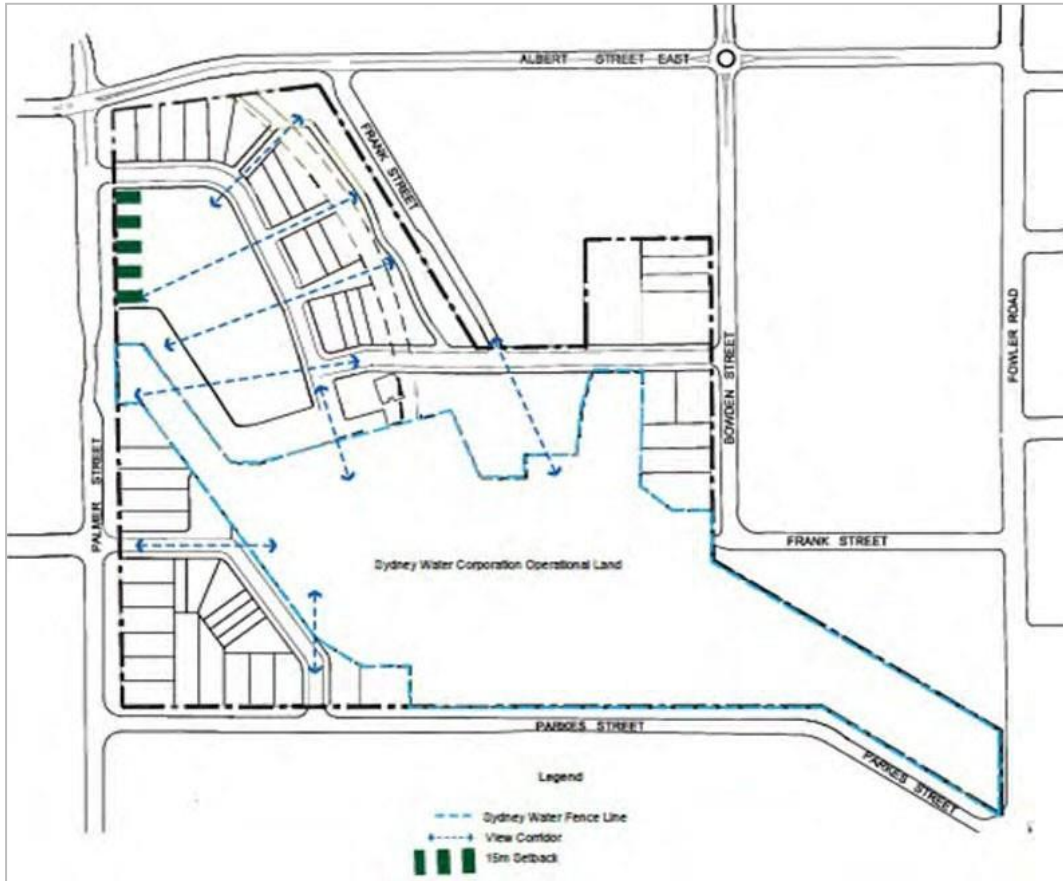

Figure 3: View corridors and setbacks

### 3.4 Landscape and Open Space

#### Objectives

- O1. Conserve existing significant vegetation within the precinct.
- O2. Enhance the appearance and amenity of the proposed development by sensitively integrating architecture and landscape through effective site planning and landscape design.
- O3. Retain and enhance the landscaped amenity of the precinct.
- O4. Provide areas of landscaped open space for a new residential community.
- O5. Integrate proposed open spaces with the surrounding landscape, open spaces and streets.
- O6. Consolidate stands of various species forming part of the Cumberland Plain Woodland endangered ecological vegetation community within the proposed open space areas.

- O7. Ensure any proposed fencing does not detract from the visual amenity and landscape character of the site, and is sympathetic to the built form of the precinct.
- O8. The streetscape character shall reinforce and enhance the road hierarchy.
- O9. Incorporate crime prevention through design principles in landscape and open space design.
- O10. Ensure that the streetscape character and tree species reflect the precincts natural character and landforms while accommodating the function needs of pedestrian, cycle and vehicular movements along each of the roads.

**Controls**

- C1. A variety of open spaces shall be provided. A number of areas have been identified by Council as suitable and are indicated on Figure 4:
  - Canal Park;
  - Community Reserve; and
  - Woodland Reserve.

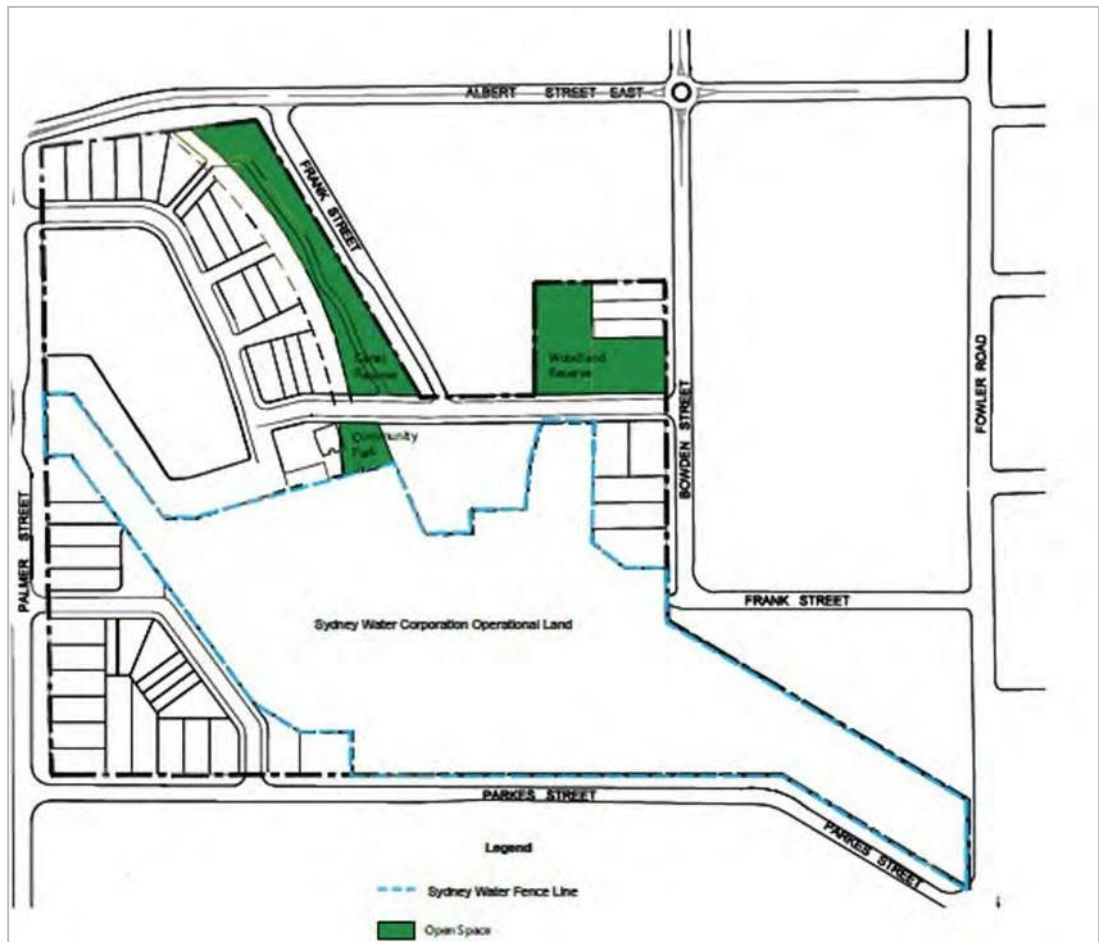

Figure 4: Open spaces map



- C2. Landscape plans shall be prepared for each proposed open space, providing the following character and facilities for each:
- Canal Park – passive and active recreation, including a children’s playground and a cycleway connecting the existing Lower Canal Cycleway with Bowden Street;
  - Community Reserve – passive recreation, including picnic and BBQ facilities; and
  - Woodland Reserve – passive recreation and native vegetation conservation.
- C3. The creation of a Heritage Square for passive recreation, including picnic and BBQ facilities is encouraged. Refer to Section 3.6.
- C4. Trees identified as high and moderate significance indicated on Figure 5 must be retained.
- C5. All other trees should be incorporated into site planning.
- C6. All tree species shall be in keeping with Council’s native tree list and be low water, low maintenance and suitable for use in urban environment. Planting shall build upon the existing landscaped character of the precinct, and not be in direct conflict with existing historical plantings.
- C7. Street trees shall be located in accordance with those indicated on Figure 5.



Figure 5: Trees map

C8. Appropriate street tree species to be planted shall be in accordance with the table below.

Table 2: Appropriate street tree species

Appropriate street tree species		
Street	Species	Common name
New Road 1 New Road 2	Angophora Floribunda	Roughed Barked Apple
	Brachychiton Acerifolius	Illawarra Flame Tree
	Waterhouse Floribunda	Weeping Lilly Pilly
Other roads and accessways	Corymbia Ficifolia 'Summer Red'	Red Flowering Gum
	Jacaranda Mimosifolia	Jacaranda
	Melaleuca linaiifolia	Snow in September
	Tristaniopius laurina	Water Gum

### 3.5 Transport and Access

#### Objectives

- O1. Provide pedestrian, cycle and vehicle connections to create permeable site.
- O2. Draw on existing infrastructure, far as possible, by incorporating existing entry points into the road design of the precinct.

#### Controls

- C1. The road structure within the precinct should be provided as shown on Figure 6.

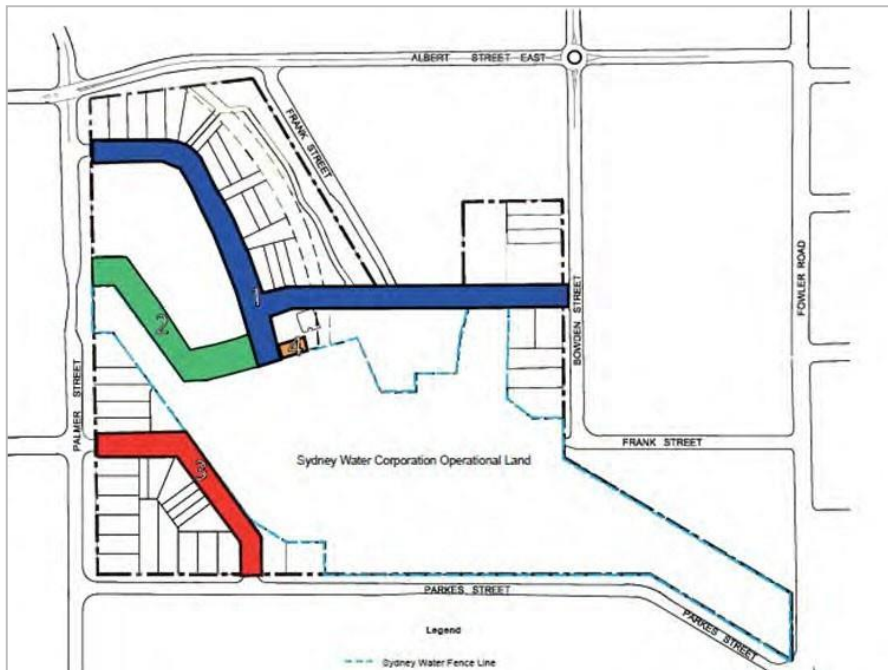

Figure 6: Road structure map



C2. Roads shall be constructed to the following specifications:

New Road 1

- 15m road reserve;
- 8m carriageway, including provision for parking on one side;
- 2.5m shared path on one side where cycleway is located;
- 1.5m footpath on one side; and
- grass verges on both sides (2m or 1.5m where cycleway is located).

New Road 2

- 15m Road reserve;
- 8m carriageway, including provision for parking on one side;
- 1.5m footpath on one side; and
- grass verges on both sides (3.5m or 2m where footpath is located).

New Road 3

- 15m road reserve;
- 8m carriageway, including provision for parking on one side;
- 1.5m footpath on one side; and
- grass verges on both sides (3.5m or 2m where footpath is located).

New Road 4

- 6m carriageway; and
- grass verges on both sides (to match New Road 2).

C3. For the purposes of Sydney Water operational requirements, New Roads 2, 4 and the southern component of new road 1 shall be designed and constructed to a standard suitable to carry the loading of a 130 tonne crane.

C4. Suitable crash prevention barriers be included in the design of New Road 2 and 4 to ensure that vehicles cannot impact on Sydney Water Operational Infrastructure.

C5. Development in Sub-Precinct A shall not have vehicular access from Palmer Street or Albert Street East.

C6. Development located between New Road 1 and the Lower Canal shall not have vehicular access from New Road 1.

C7. Vehicular access to lots located between New Road 1 and the Lower Canal may be provided through a shared private accessway located within a view corridor shown on map 4.

## **3.6 Heritage**

### **Objectives**

O1. Acknowledge the historically significant role the precinct and the existing Sydney Water site combined played in delivering Sydney's water supply.

O2. Provide visual continuity across the site so there are vistas into the Sydney Water site from the surplus land.

- O3. Maximise public access through the site as well as adjacent to the Sydney Water boundary so that the Sydney Water function is readily apparent.
- O4. Retain existing structures within the precinct to provide a connection with the character of the former use of the site.
- O5. Interpret the history of the site through the retention of structures and moveable heritage items located in the precinct.
- O6. Ensure the upper canal is a distinct landscape element of the site.
- O7. Retain significant landscape vegetation, to allow interpretation of the site and landscape continuity between the precinct and the Sydney Water site.

### **Controls**

- C1. Development shall be sited to maintain significant view corridors between the precinct and the established residential area, as identified on Figure 4.
- C2. Roads and residential development shall be located to maximise views into the operational Sydney Water site.
- C3. Moveable items located in the precinct, that contribute to the story of the site and the history of water supply in Sydney should be retained and incorporated into the landscape as sculptural elements.
- C4. Existing landscape vegetation, identified as significant heritage landscape elements are to be retained in order to provide interpretation of the site and continuity between the precinct and the Sydney Water site.

*Note: Figure 5 details significant landscape vegetation to be retained.*

- C5. Public interpretation strategy for the lower canal and Pipehead site shall be developed and implemented during redevelopment of the site.
- C6. Development in the precinct shall be designed to follow and not disrupt the topography of the landscape.
- C7. Black palisade fencing shall be erected between the residential and operational lands within the precinct.

### Adaptive reuse of Building 25 structure

*Note: Building 25 was originally built as a storage depot for the construction of the Warragamba Dam and relocated to Guildford.*

- C8. Part of the structure of building 25 shall be retained in order to:
  - provide a significant visual landmark element that recognises the former use of the site;
  - visually connect the residential lands with the continuing operational Sydney Water site; and
  - interpret the former use of the Pipehead site.
- C9. Any part of the structure of building 25 retained within the proposed Heritage Square may be used for general recreation or social purposes and may retain a part of the roof sheeting for sun shading.

- C10. The roof character of new buildings shall integrate with, and not effect the character of the precinct.

*Note: It is recommended that gable and hipped roofs are to have a pitch of 20 – 30 degrees, to match that of existing Building 25, while skillion roofs are to have a pitch of 10 degrees.*

Sub-Precinct A

- C11. Housing within Sub-Precinct A should include a mixture of residential flat buildings, multi dwelling housing, attached housing and detached housing on small lots.

Sub-Precinct B

- C12. Housing within Sub-Precinct B should include a mixture of residential flat buildings, multi dwelling housing, attached housing and detached houses.

Sub-Precinct C

- C13. Housing within Sub-Precinct C should include a mixture of multi dwelling housing, attached housing and detached houses.

This page has been left intentionally blank.



CUMBERLAND  
CITY COUNCIL

# **PART F1-11 HEREFORD PLACE, WENTWORTHVILLE**

This page has been left intentionally blank.

# 1. Introduction

## 1.1 Land to which this Part applies

This Part applies to development on land as detailed within this Part.

The Hereford Place precinct comprises the land described in Table 1 below, known as 20-44 Jersey Road and 23-45 Hampden Road, South Wentworthville and as indicated on Figure 1. Medium density residential development is envisaged for this precinct.

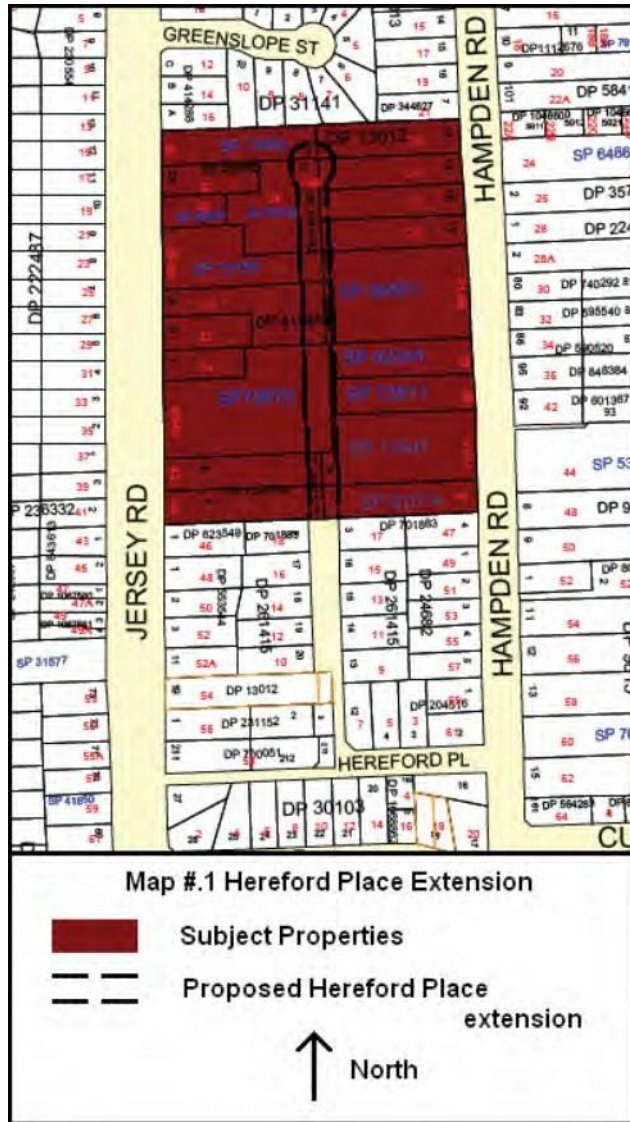

Figure 1: Hereford Place extension

Property Address	Lot and DP or SP No.
20 Jersey Road (Cumberland Hwy) South Wentworthville	SP73491
22 Jersey Road (Cumberland Hwy) South Wentworthville	Lot 2A DP406503
24 Jersey Road (Cumberland Hwy) South Wentworthville	SP68037
24A Jersey Road (Cumberland Hwy) South Wentworthville	SP68192
26-28 Jersey Road (Cumberland Hwy) South Wentworthville	SP73156
30 Jersey Road (Cumberland Hwy) South Wentworthville	Lot A DP412854
32 Jersey Road (Cumberland Hwy) South Wentworthville	Lot B DP412854
34 Jersey Road (Cumberland Hwy) South Wentworthville	Lot A DP414666
36-40 Jersey Road (Cumberland Hwy) South Wentworthville	SP79670
42 Jersey Road (Cumberland Hwy) South Wentworthville	Lot 4 DP1138704
44 Jersey Road (Cumberland Hwy) South Wentworthville	Lot 3 DP1138704
23 Hampden Road, South Wentworthville	Lot 14 DP13012
25 Hampden Road, South Wentworthville	Lot 13 DP13012
27 Hampden Road, South Wentworthville	Lot 12 DP13012
29 Hampden Road, South Wentworthville	Lot 11 DP13012
31-35 Hampden Road, South Wentworthville	SP66581
37 Hampden Road, South Wentworthville	SP42344
39 Hampden Road, South Wentworthville	SP73811
41-43 Hampden Road, South Wentworthville	SP77447
45 Hampden Road, South Wentworthville	SP81074

*Table 1: Land subject to Section 1 of this Part*

## 2. Vision

Medium density residential development requires adequate local road access. However, half of the properties within this precinct have vehicular access only from the Cumberland Highway (also known as Jersey Road). This is unsatisfactory given that the Highway is primarily a metropolitan arterial road. Given this, the provision of alternative vehicular access to these properties is required to facilitate satisfactory development and minimise traffic conflicts on the Highway.

To provide this alternative vehicular access, it is proposed to extend Hereford Place north from Jersey Lane. To achieve this, land is required from properties currently fronting both the Cumberland Highway and Hampden Road. To minimise traffic conflicts and congestion on Hampden Road, and to prevent private driveways from being used by through traffic, access from Hampden Road will not be permitted for redeveloped properties.



### 3. Objectives and Controls

#### Objectives

- O1. Facilitate the reasonable development of the Hereford Place precinct by permitting the extension of Hereford Place, Wentworthville.
- O2. Minimise vehicular access to properties from the Cumberland Highway.
- O3. Ensure that alternative vehicular access is provided to properties with frontage to the Cumberland Highway, South Wentworthville.
- O4. Reduce vehicular traffic and conflicts on Hampden Road, South Wentworthville, by providing alternative vehicular access from an extended Hereford Place.

#### Controls

- C1. This section of the DCP applies to all development within the Hereford Place precinct, as indicated in Table 1 and shown on Figure 1.
- C2. Development for the purposes of additions and alterations to existing detached dwelling houses is excluded from the provisions of this section.
- C3. All development shall provide for future permanent vehicular access from the Hereford Place extension.
- C4. Land shall be dedicated for the Hereford Place extension in accordance with Figure 1.
- C5. An 8m wide vehicular carriageway shall be constructed along the proposed extension of Hereford Place, with a 4m footpath verge with a roll-top kerb along either side.
- C6. Road layout and geometry shall be in accordance with the provisions of Part G of this DCP and with other approved standards, either the *Guide to Traffic Engineering Practice* published by NAASRA, or the Roads and Maritime Services guidelines.
- C7. For all development except the erection of a dwelling house, all roadworks, including drainage, kerb and gutter and footpaths, shall be constructed at the applicant's expense and the required land dedicated to Council prior to release of any occupation certificate. Alternatively, Council may accept lodgement of a bond, through a bank guarantee, for the agreed value of the works plus interest for 10 years, in lieu of construction of the works.
- C8. For the erection of a new detached dwelling house, all roadworks, including drainage, kerb and gutter and footpaths, shall be constructed at the applicant's expense and the required land dedicated to Council prior to release of any construction certificate.
- C9. A restriction to use under Section 88B shall be included upon the title, with Council listed as a party, to require no access from either the Cumberland Highway or Hampden Road, upon extension of Hereford Place to the subject property.
- C10. Temporary access shall be permitted from the Cumberland Highway or Hampden Road until such time as all land dedication and road construction for the Hereford Place extension is completed between Jersey Lane and the subject property.

- C11. Approval of temporary access from the Cumberland Highway or Hampden Road shall be subject to the agreement of the Roads and Maritime Services and any affected landholders.
- C12. At such time as all land dedication and road construction for the Hereford Place extension is completed between Jersey Lane and the subject property, the following works shall be carried out at the expense of the landowner(s):
- all necessary works to permit vehicular access from Hereford Place, including removal of fences and construction of a suitable vehicular driveway from the property boundary to the kerb-line;
  - all necessary works required to deny access from the Cumberland Highway or Hampden Road, including erection of fencing at the property line and removal of any vehicular driveway from the property boundary to the kerb-line.

This page has been left intentionally blank.



CUMBERLAND  
CITY COUNCIL

# PART F1-12 HILLIER STREET, MERRYLANDS

This page has been left intentionally blank.

# 1. Introduction

## 1.1 Hillier Street, Merrylands

Hillier Street, Merrylands (Hilltop) is an incomplete cul-de-sac, where subdivision and development has not yet permitted the construction of a turning bulb. This section of the DCP is intended to guide future development within the precinct to ensure that a turning bulb may be constructed without unnecessarily preventing development of properties zoned R3 Medium Density Residential.

# 2. Specific objectives and controls

## Objectives

- O1. Facilitate the reasonable development of the Hillier Street precinct by permitting the completion of Hillier Street, Merrylands.
- O2. Ensure that further development results in the completion of Hillier Street.
- O3. Minimise the number of properties required to dedicate land to Council.
- O4. Ensure that 82 Clarence Street retains the opportunity to subdivide broadly in accordance with Council's previous development control plan.

## Controls

- C1. This section of the DCP applies to all development within the Crosby Street precinct, as indicated in Table 1 and shown on Figure 1.
- C2. Development for the purposes of the erection of a new detached dwelling house and additions and alterations to an existing, detached dwelling house is excluded from the provisions of this section.
- C3. Land shall be dedicated to Council to allow creation of the cul-de-sac head in accordance with the layout shown on Figure 1.
- C4. Land dedication is to occur prior to the redevelopment of 69 and 71 Burnett Street for medium density housing.
- C5. Medium density residential development of 69 and 71 Burnett Street is subject to:
  - amalgamation of these properties;
  - a boundary adjustment between 69 Burnett Street and 82 Clarence Street, in accordance with Figure 1, to ensure that the later has a frontage to the Hillier Street extension; and
  - vehicular access to the amalgamated site is only provided from the Hillier Street extension.
- C6. An appropriate cul-de-sac turning bulb is to be constructed within the area shown on Figure 1.
- C7. Road layout and geometry shall be in accordance with the provisions of Part G, of this DCP and with other approved standards, either the *Guide to Traffic Engineering Practice* published by NAASRA, or the Roads and Maritime Services guidelines.

- C8. All roadworks, including drainage, kerb and gutter and footpaths, shall be constructed at the applicant's expense and the required land dedicated to Council prior to release of any Subdivision or Occupation Certificate. Alternatively, Council may accept lodgement of a bond, through a bank guarantee, for the agreed value of the works plus interest for 10 years, in lieu of construction of the works.

Table 1: Land subject to Hillier Street extension

Property Address	Lot No.	DP
71 Burnett Street	5C	398018
69 Burnett Street	5D	398018
82 Clarence Street	8	22133
80 Clarence Street	4	23384

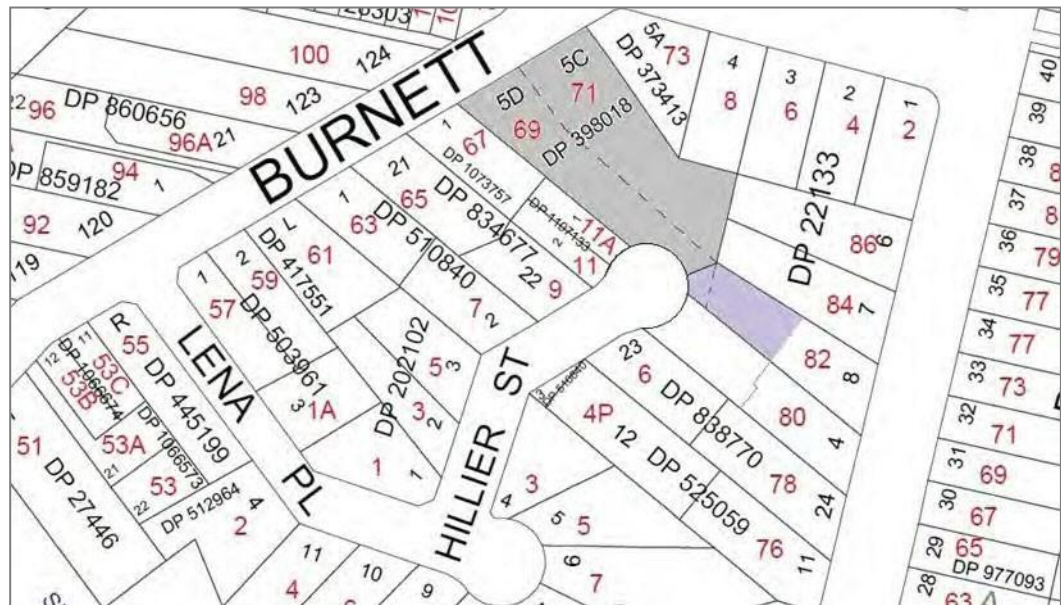

Figure 1: Hillier Street extension:

This page has been left intentionally blank.





CUMBERLAND  
CITY COUNCIL

# PART F1-13

# HOLROYD GARDENS

This page has been left intentionally blank.

# 1. Introduction

This Part of *Cumberland Development Control Plan 2021* provides a framework that will guide future development in Holroyd Gardens.

The controls and guidelines demonstrate Cumberland City Council’s commitment to ensuring redevelopment of the former Goodlet and Smith Brickworks site takes place in a sensitive, sustainable and exemplary manner.

Both Council and the joint venture development partner, Delfin Property Group, are committed to ensuring development of the site is of the highest quality.

## 1.1 Land to which this Part applies

This Part applies to land known as “Holroyd Gardens”, located adjacent to Walpole Street, the Main Southern Railway and Walpole Street Park, Holroyd. The site is defined by the locality plan (Figures 1 and 2) Boundaries for this DCP may be extended in future by the inclusion of additional lands. Where this is the case, the DCP will be amended accordingly.

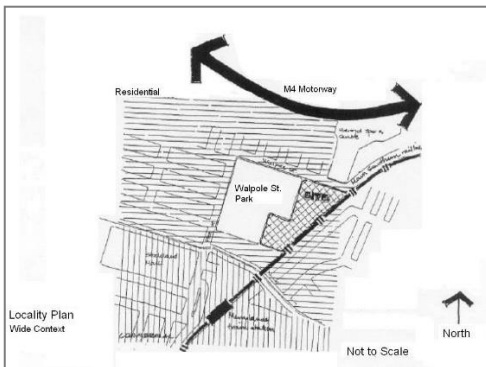

Figure 1: Locality plan - wide context

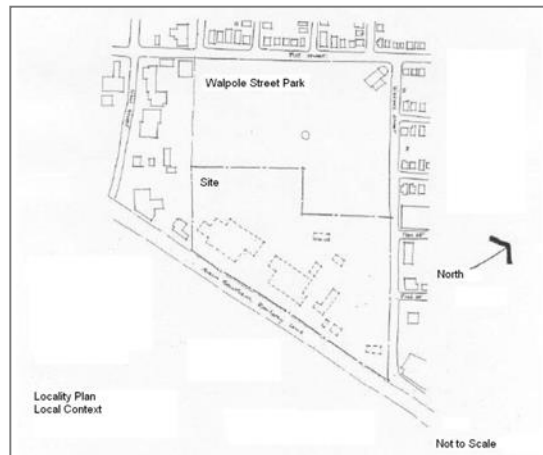

Figure 2; Locality plan – local context

## 1.2 Relationship to other Parts of this DCP

Part F of *Cumberland DCP 2021* shall be read in conjunction with the following Parts of *Cumberland DCP 2021*, which contain Objectives and Development Controls that relate to development in this Part:

- Part A – Introduction and General Controls;
- Part B – Development in Residential Zones;
- Part C – Development in Business Zones;
- Part E – Other Land Use Based Development Controls;
- Part G – Miscellaneous Development Controls; and
- Definitions.

## 2. Vision and general objectives

### 2.1 Vision and context

Holroyd Gardens is intentionally considered as a garden neighbourhood, with ample open space throughout and the distinctive heritage precinct being actively used as interpretation, open space and community facilities at the heart of the neighbourhood.

A wide linear parkway traverses the length of the neighbourhood and has adjacent to its mid point a large artificial wetland. The site is also directly connected to Walpole Street Park, which extends through to the Heritage Precinct. This combined park system enables all residents to have easy access to a variety of pleasant recreation opportunities.

The main road system and pathway system through the centre of the neighbourhood is intended to give all residents easy access to Walpole Street Park and the Merrylands Town Centre. The road system and attention to streetscape gives the neighbourhood a distinctive character.

With the exception of the Heritage Precinct, the site will be developed for residential and activities ancillary to such residential development, such as open space and home offices.

Based on the current indicative Master Plan, this DCP envisages that the site will have a maximum density of 260-280 dwellings, comprised of a mix of detached, semi-detached and medium density multi- unit housing. Council may at its discretion consider and approve a variation to the Master Plan where compelling economic, environmental or social grounds are present, and where the overarching objectives and principles of this DCP can be achieved.

### 2.2 Objectives

#### General

- O1. Redevelopment of the former Goodlet and Smith Brickworks site should:
  - be responsive to the needs of the community,
  - achieve high levels of design and appearance,
  - be responsive to the heritage significance of the site, and
  - be well integrated with its surrounding urban context.
- O2. Ensure that the urban structure, layout and form of the development responds positively to its urban context, Specifically:
  - incorporation and extension of Walpole Street Park into and through the site;
  - establishing open space links, including pedestrian and bicycle linkages, which connect the site with Walpole Street Park, Merrylands Town Centre and areas further afield; and
  - ensure an appropriate and supportive frontage to Walpole Street and Walpole Street Park
- O3. Ensure a supportive relationship with the heritage significance of the site. Specifically:
  - conserve and refurbish significant heritage buildings within an established heritage precinct;
  - Introduce activities within the heritage precinct in order to ensure that the area becomes a “seamless” component of the greater site; and
  - Implement specific controls for areas in close proximity to heritage items that ensure new buildings are complementary and not mimicking in terms of form and appearance.
- O4. Ensure that buildings on the site provide a supportive relationship with the public domain and appropriately respond to the needs of pedestrians.

- O5. Enable a wide choice of housing types, including adaptable housing, in order to effectively respond the changing need of the community and residential market.
- O6. Provide a high level of amenity for future residents and users of the site through the provision of a coordinated palette of urban elements including furniture, lighting, paving and vegetation.

## 2.3 Access and linkages

### Collector Road

A collector road serves to provide a link road through the project. The collector road will have a strong landscape amenity with a regular row of advanced trees and wide verges with wide foot paths/cycleways. The collector road commences at Walpole Street near the Fox Street intersection.

### Park Edge Terraces

Park Edge Terraces are positioned along the flanks of the Linear Park and elsewhere. These Terraces have two advantages: They allow access to houses overlooking the reserve; and, they also allow access to the Walpole Street Reserve, allowing the eastern side of the park to be accessible to potential users.

### Cycleways and pedestrian paths

Cycleways and pedestrian paths are aligned with the open space system as well as streets. These cycleways and pathways link towards:

- Merrylands Town Centre;
- A'Becketts Creek;
- Merrylands railway station; and
- The Heritage Precinct.

## 2.4 Open spaces

### Public open spaces

The open space system within Holroyd Gardens is extensive and provides variety of spaces appropriate for a wide range of activities. These include:

- linking visually and physically the heritage precinct buildings with the Walpole Street Reserve;
- the formation of a linear parkway that provides visual amenity, recreation areas and pedestrian/cycle linkages;
- the retention and the re-use of several of the former brickworks buildings as a centre piece for community use;
- a central open area adjacent to the Heritage Precinct, opens up to the linear parkway and lake, and provides direct visual links with Walpole Street Park; and
- creation of a variety of landscaped spaces throughout the neighbourhood.

### Semi public/semi private open spaces - front gardens

The amenity of the front gardens is important for extending the general quality of Holroyd Gardens landscape system.

The front yard areas of housing are considered as an opportunity to extend the quality of the street landscape into the front areas of the housing. Colourful front area planting is encouraged.

## 2.5 Built form

### Objectives

#### Density and building height

- O1. Housing is placed so that there is a clear transition in building height and bulk from Walpole Street, towards the railway line and from the Heritage Precinct outwards. This enables the gradual change in density from key elements of the open space system, as well as the vehicular and pedestrian approaches to the housing areas.
- O2. Housing is positioned so that all houses provide direct surveillance of the proposed street and open space systems, with the majority of housing positioned so that it has frontage to reserves and open space. This strategy encourages a high level of community supervision of the open space areas, as well as maximising the benefit of the open space system to the enjoyment of the residents.
- O3. Housing is grouped in order to provide areas with opportunity for distinct residential character. There are areas of terrace housing for instance forming two “crescents” facing open spaces. Multi- unit housing is placed alongside the Linear Parkway as well as the Collector Road. The longer building forms of the multi- unit dwellings assist in providing a noise buffer alongside the railway corridor.
- O4. Residential buildings are to complement heritage buildings within and adjacent to the heritage precinct. It is intended that the addition of any new residential buildings will encourage a higher degree of supervision and better use of the heritage precinct. New buildings adjacent to heritage buildings are to complement (though not mimic) the heritage buildings by virtue of their height, scale, bulk, materials and appearance.

## 2.6 Streetscape

A high level of attention to streetscape is a key principle to the visual success of the Holroyd Gardens. This applies to the areas immediately fronting the street, as well as those spaces that are visible from the street.

### Objectives

- O1. The streetscape should be characterised by buildings with individual variety that give interest, while still forming a cohesive sense of neighbourhood.
- O2. Ensure that each of the individual houses or groups of houses reinforce and add to the tree lined street environment with a high level of private area planting.
- O3. Ensure consistent frontages, ridge heights and eave heights.
- O4. Require a variety of materials within an agreed palette of building materials to be used.

## 2.7 Building envelope

### Objectives

- O1. Ensure housing is considered in terms of its relationship to adjoining buildings to encourage the reinforcement of street enclosure and street character.
- O2. Encourage verandahs and projecting awnings, “Dutch Gable” roof forms and similar techniques that “break up” the roof shape.

- O3. Ensure long flat faced walls are avoided. Walls should incorporate bay windows, porches, small verandahs, French windows to give relief and articulation to exterior walling, and provide internal amenity.

## **2.8 Adaptable housing**

### **Objective**

- O1. Ensure housing addresses, where practicable, the needs of the disabled and the elderly.

## **2.9 Energy efficiency**

### **Objective**

- O1. Ensure housing demonstrates attention to energy efficient design by:
- Maximising north orientation;
  - The use of wall and ceiling insulation;
  - Building forms that allow cross ventilation and zoned heating and cooling;
  - The use and sensible placement of thermal mass; and
  - Appropriate landscape placement.

## **2.10 Waste management**

### **Objective**

- O1. Ensure the provision of adequate dedicated spaces for the storage of waste and recycling away from street. Adequate storage is required for all dwellings.

## **2.11 Off street parking**

### **Objectives**

- O1. Ensure parking complies with Council's provisions and is to be designed so as to reduce visual impact on the streetscape.
- O2. Ensure driveways are designed to minimise the area of hard paving to a practicable minimum.

# **3. Specific objectives and controls**

## **3.1 Open space**

### **Objectives**

- O1. The open space system is generally as defined in Figure 3.
- O2. Open space on the site will be interpreted as a continuous system, comprising places (the heritage precinct, landscaped spaces etc) and linkages (linear park corridor, streets etc).
- O3. All parks are to be highly accessible, as well as framed and defined by the street system.
- O4. The site is to provide for linkages to the wider open space system, such as the regional bicycle corridor and Walpole Street Park.
- O5. Streets are important elements of the open space system. They should provide direct links between key open space destinations.

Pedestrian linkages

- O6. The pedestrian system is generally as defined in Figure 3.
- O7. A Linear Park Corridor, generally corresponding to the alignment of A'Becketts Creek, will allow for a future pedestrian and bicycle linkage between the site, Merrylands and areas to the north. It will also incorporate a segment of the regional bicycle system.
- O8. A strong pedestrian linkage will be developed between the Heritage precinct, artificial wetland, and will eventually continue on to the rotunda and Children's Museum in Walpole Street Park. This pathway will provide a strong physical and visual link between Walpole Street Park attractions, the heritage precinct and the site generally.
- O9. Secondary pedestrian linkages will be provided adjacent to Walpole Street park, adjacent to Walpole Street and south west through Walpole Street Park, linking Merrylands to the site.

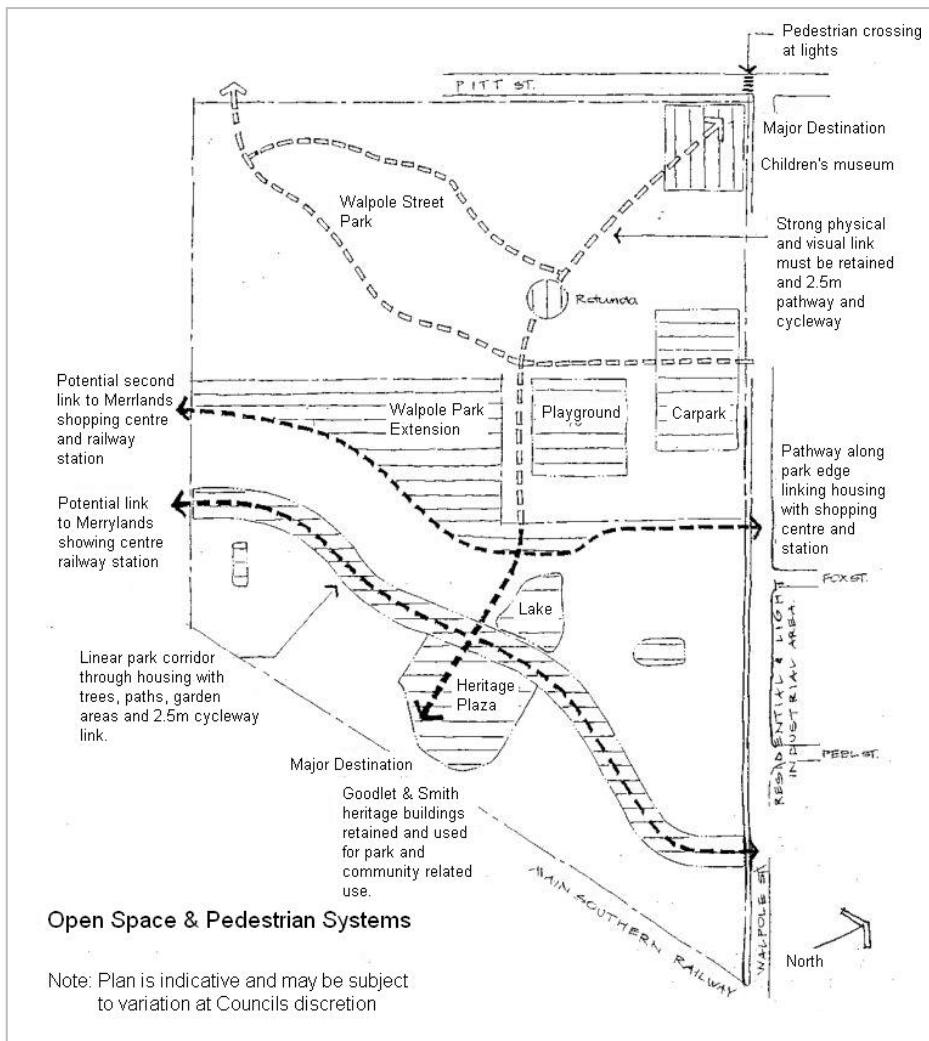

Figure 3: Open space and pedestrian systems map



Landscape

- O10. A coordinated landscape master plan for the entire site will be developed and implemented.
- O11. Plant species chosen for the site should be appropriate in terms of meeting the functional requirements of the environment in which they are to be utilised.
- O12. The Heritage Precinct and link with Walpole Street Park will be enhanced through the use of (complementary) feature planting.
- O13. Each Precinct and/or each major street type will contain subtle differences in landscape approach in order to accentuate legibility.

3.1.1 Elements of the Open Space System

The Heritage Precinct

The Heritage Precinct is located generally adjacent to the Main Southern Railway line, in a central location between Walpole Street and the southern boundary of the site. The location and extent of the Heritage Precinct is defined in Figure 4.

The Heritage Precinct should be the focus of development on the site. Refer to the Development Strategy for the Heritage Precinct of the Goodlet and Smith Brickworks Site.

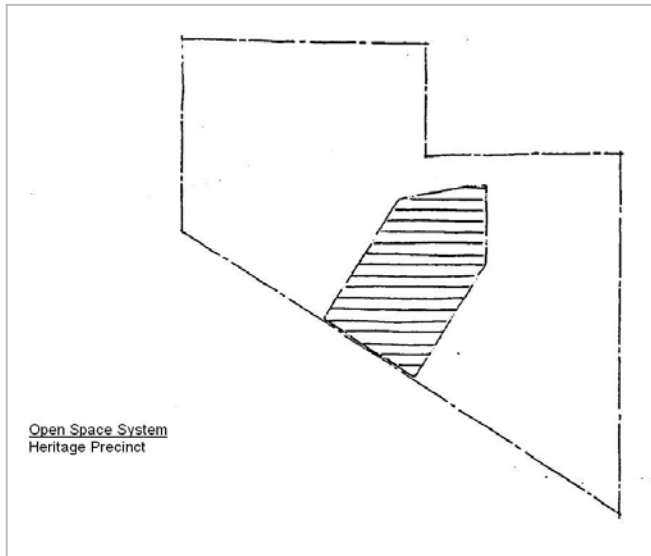

Figure 4: Open space system - Heritage precinct

### Linear Park Corridor

The location of the linear park corridor is described in Figure 5.

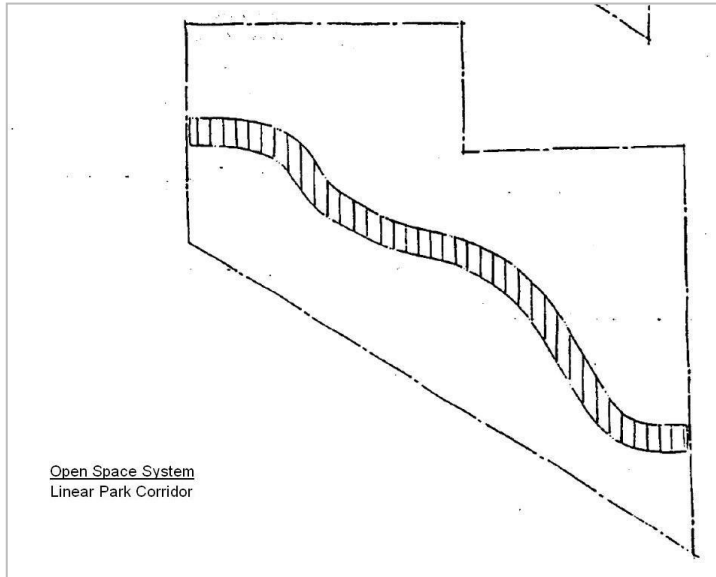

Figure 5: Open space system - linear park corridor

### **Objectives**

- O1. Encourage the relocation of the weir currently located within the existing A'Becketts Creek alignment to a position within the Linear Park Corridor is encouraged. This will be confirmed following detailed hydraulic investigation ensuring the ability to maintain adequate flood capacity.

### **Controls**

- C1. The Linear Park corridor will be approximately 19m in width.
- C2. The Linear Park corridor is to be accessible from both sides and is to incorporate a pedestrian and bicycle path of at least 2.5m width
- C3. The Linear Park Corridor is to accommodate a component of the overland flow generated by development on the site and is to incorporate substantial planting and other landscape treatments to accentuate its appearance as a "creek-like" corridor.

### 3.1.2 Extension to Walpole Street Park

#### **Objectives**

- O1. Provide a pedestrian connection to the principal east-west linkage between the Park and Heritage Precinct.
- O2. Maximise casual surveillance from adjacent residences.
- O3. Ensure the park extension is well lit.
- O4. Ensure Walpole Street Park is to be highly accessible.

**Controls**

- C1. Walpole Street Park is to be extended to a new boundary alignment immediately adjacent to residential development on the site (see Figure 6).
- C2. The extension area of Walpole Street Park is to incorporate an informal pedestrian path linking Walpole Street to the southern extent of the site.
- C3. Planting in the Walpole Street Park extension area is to be ground covers or clean trunked tree species only.

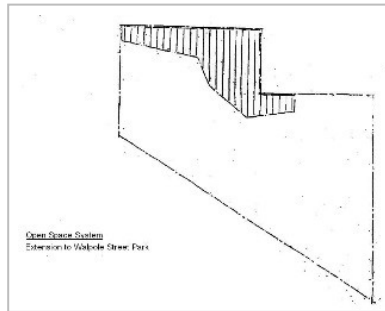

Figure 6: Open space system - extension to Walpole Street Park

3.1.3 Landscaped Spaces

**Objective**

- O1. Ensure high quality landscapes spaces are provided at various locations throughout the site.

**Controls**

- C1. The design of landscape spaces should complement and contribute to the urban setting and add value and amenity to adjacent areas. In addition, they should be designed to:
  - be environmentally sustainable, particularly in their use and demand for water;
  - clearly convey a message that they are available and meant to be used;
  - allow a range of potential activities;
  - be engaging from the outside and within; and
  - foster a safe and secure public domain.

3.1.4 Pedestrian and Cyclist Facilities

The off-street pedestrian system is comprised of formed paths of either 2.5m width for major linkages and pedestrian/bicycle linkages, or 1.5m width for secondary (pedestrian only) linkages. These are detailed in Figure 3.

**Objective**

- O1. Ensure all pedestrian and cyclist paths allow high levels of casual surveillance through their location, lighting and form of adjacent planting.

**Development Controls**

- C1. All footpaths adjacent to streets are to be a minimum of 1.5m width.
- C2. Footpaths are to be provided adjacent to streets according to the following schedule:

Table 1: Footpath provision

Street/location	Footpath provision
Collector Road	at least one side
Access Street	at least one side
Access Street serving a maximum of 8 dwellings	none required
Park Edge Terrace	at least one side
Shared Accessway	none required

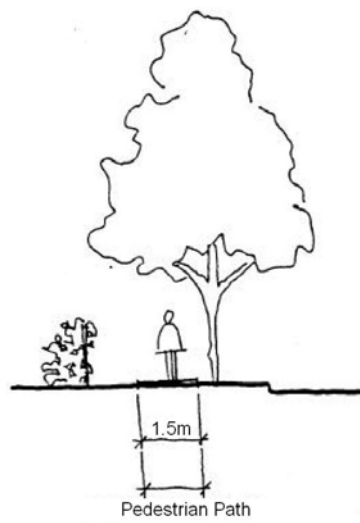

Figure 7: Pedestrian park

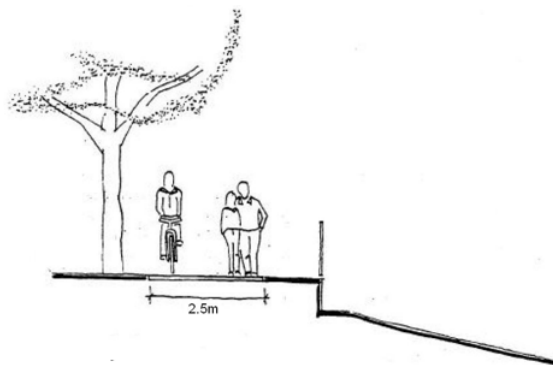

Figure 8: Pedestrian and cyclist facilities



**Controls**

- C1. Require streets to frame and define key public spaces.
- C2. Ensure the provision for the requirements of emergency and service vehicles are made.

Street character

**Objective**

- O3. Ensure streets are designed such that they are appropriate for all potential users. The design of the street environment should support the establishment of distinct zones of activity, including public space (traffic, parking and pedestrian zones), semi-public space (front yards and porches) and private space (within the building).

**Controls**

- C1. Buildings shall be sited so that they provide strong definition of the public realm. The ratio of building height (at any point) to the horizontal distance between buildings (at a corresponding point), across a street, should generally fall between 1:1.25 and 1:3.7, except in areas adjacent to heritage items. A ratio of up to 1:3.7 will be allowed in cases where smaller buildings are to be located opposite apartment buildings.
- C2. In situations where no other building has been proposed for across the street, the horizontal distance between buildings is assumed to be the distance between the proposed building and the maximum building setback (as defined in Clause 4.2) behind the opposite verge/property boundary.
- C3. Streets are to be designed such that there is a clear distinction and progression from private space to semi public, to public space.
- C4. Buildings shall be sited and designed to maximise casual surveillance of the public realm.

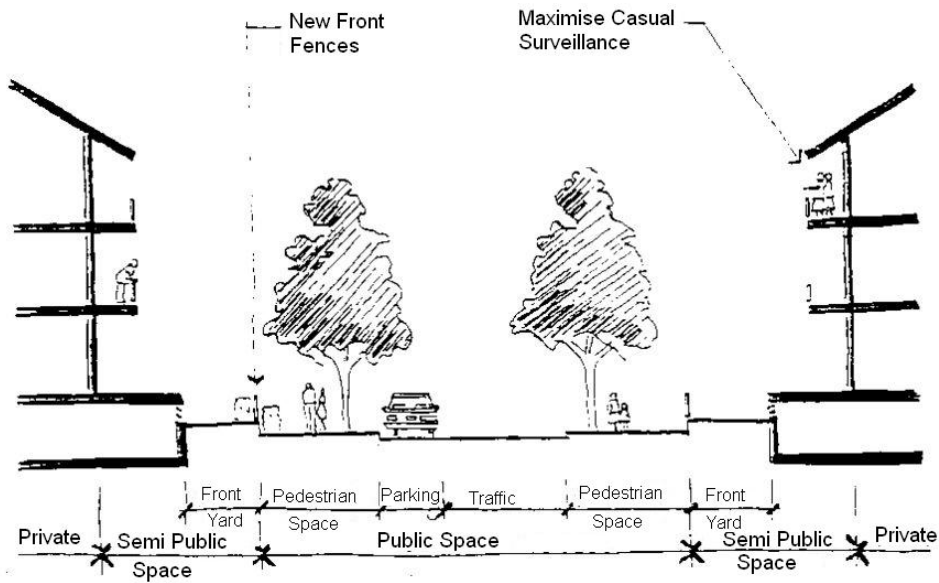

Figure 10: Street character - cross section

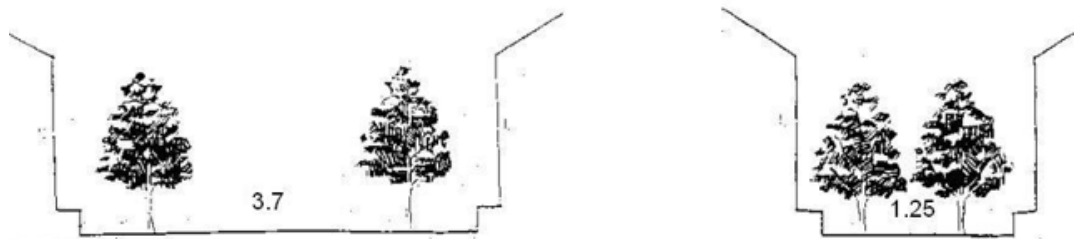

Figure 11: Street character – building height to road length

### Principal entrance

The principal entrance to the site will be from Walpole Street, adjacent to the Walpole Street Park boundary.

### **Objectives**

- O1. Allow for a possible second entrance to the site to align with Peel Street.
- O2. Ensure the main entrance is to be designed to provide and coordinate with speed and traffic control on Walpole Street.
- O3. Ensure the main entrance will be designed to reflect its role as a gateway to the site.

### 3.2.2 Street Types and Dimensions

#### Collector road

#### **Objectives**

- O1. Provide a principle access for the entire site by connecting with Walpole Street adjacent to Walpole Street Park and circulating east around the heritage precinct.
- O2. Make provisions for future connections with residential development to the south of the site.
- O3. Allow all potential housing types to have frontage to the Collector Road.

#### **Controls**

- C1. Typical street sections for the collector road are illustrated in Figure 15:
  - carriageway: 8m wide kerb to kerb over its entire length (any variation to be demonstrated to the satisfaction of Council’s Engineer);
  - verge area: 3m - 3.75m (both sides);
  - building setback: 4.5m maximum to the principal façade; and
  - the verge area may be reduced to 1.5m on one side where the collector road has development frontage to only one side.
- C2. Council may consider variations to the above dimensions only where overarching principles for Street System, Street Character and Street Landscape (Section 3.3.1) are achieved.

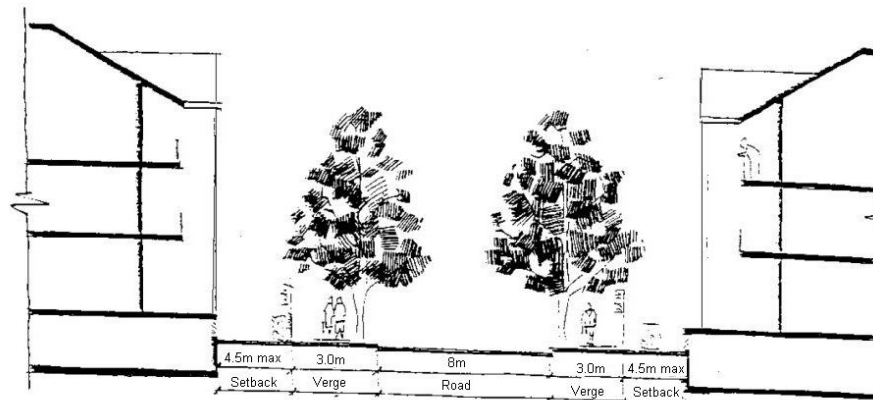

Street Types  
Collector Road

Note: Drawing is indicative and may be subject to variation at Council’s discretion

*Figure 12: Street types – collector road*



### Park edge terrace

The Park Edge Terrace is a street type which has dwellings located on one side and park frontage on the other.

#### **Objectives**

- O4. Increase the level of casual surveillance, thereby enhancing activity, safety and security for park users through the positioning of a road between buildings and the park.
- O5. Allow all potential housing types to have frontage to the Park Edge Terrace.

#### **Controls**

- C3. A typical street section for the Park Edge Terrace is illustrated in Figure 16:
  - carriageway: 6.5 – 7m maximum;
  - verge area: 3 - 3.75m to development side 1.5m to the park side; and
  - building setback: 4.5m maximum to the principal façade.
- C4. Council may consider variations to the above dimensions only where overarching principles for Street System, Street Character and Street Landscape (Section 3.3.1) are achieved.

### Access streets

#### **Objectives**

- O6. Provide access streets that connects with the collector road and may be either through routes or cul-de-sacs.

#### **Controls**

- C5. Typical street sections for Access Streets are illustrated in Figure 17:
  - carriageway: 6.5-7m;
  - verge Area: 3 - 3.75m (both sides); and
  - building Setback: 4.5m maximum to the principal façade.
- C6. The verge area may be reduced to 1.5m on one side where the access street has development frontage to only one side, or where the access street is a cul-de-sac and serves no more than 8 dwellings.
- C7. Council may consider variations to the above dimensions only where overarching principles for Street System, Street Character and Street Landscape (Section 3.3.1) are achieved.

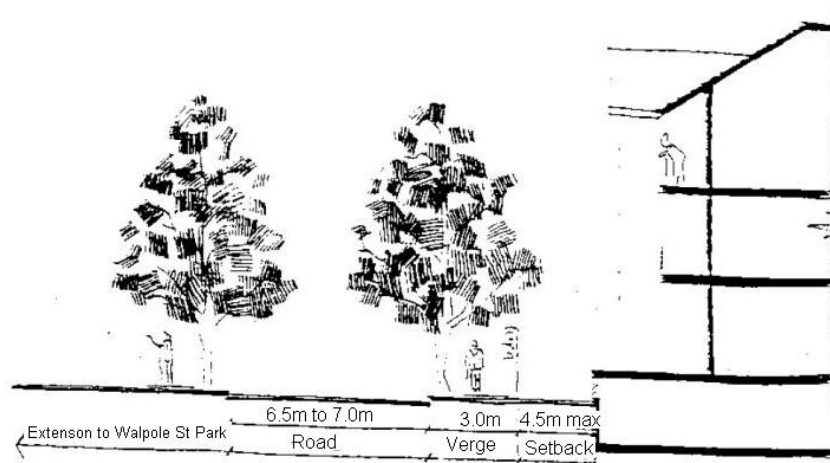

**Street Types**  
Park Edge Terrace

Note: Drawing is indicative and may be subject to variation at Council's discretion

Figure 13: Street types – park edge terrace

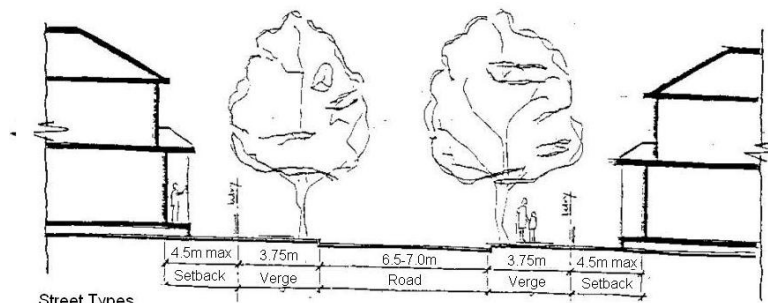

**Street Types**  
Access Street

Note: Drawing is indicative and may be subject to change at Councils discretion

Figure 14: Street types – access street

**Shared accessway**

**Objectives**

- O7. Allow for shared accessways which may be provided at various locations within Holroyd Gardens and will serve only a limited number of dwellings.
- O8. Ensure the shared accessway will be designed in a manner which provides equal priority for both pedestrians and vehicles.

**Controls**

- C8. A typical street section for the Shared Accessway is illustrated in Figure 15. Final dimensions and street design is subject to RMS concurrence:
- carriageway: 5m - 6.5m maximum;
  - verge area: none required; and
  - building setback: 4.5m maximum to the principal façade.
- C9. Turning areas shall be provided for garbage services and delivery trucks in the form of 8m radius turning bulbs or equivalent turning areas within the road reserve at the end points of roads or at a location where garbage trucks can service residences.
- C10. Allowance shall be made for visitors to the Heritage Precinct to turn and exit the site in that vicinity.

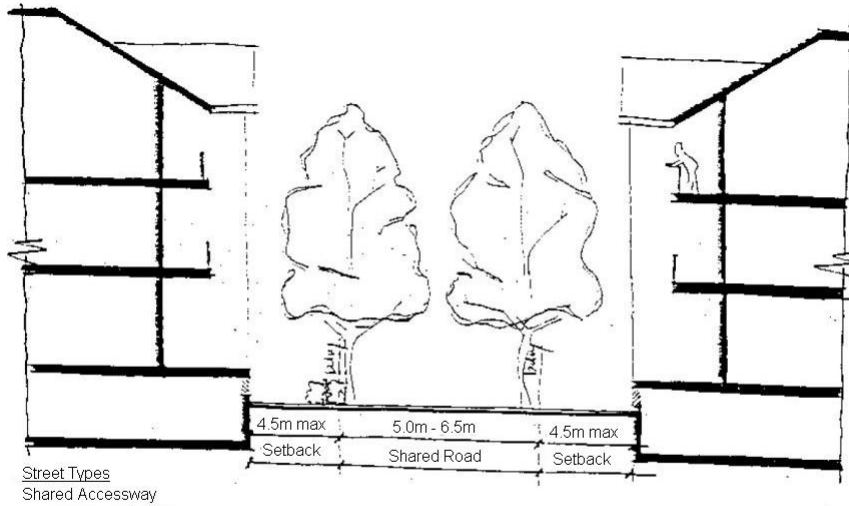

Note: Drawing is indicative and may be subject to change at Councils discretion

Figure 15: street type – shared accessway

**3.2.3 Road Intersections**

**Objectives**

- O1. Ensure all road intersections encourage safe vehicle movement.
- O2. Make provisions for efficient and safe pedestrian movement.

**Controls**

- C1. Require minimum curb radius profiles to encourage slower vehicle turns.
- C2. Pram ramps are to be provided for all pedestrian crossing movements.

On street parking

**Controls**

C3. On Street parking will be available on all streets according to the following schedule:

*Table 2: Parking provisions*

Street/location	Parking provision
Collector Road	at least one side
Access Street	at least one side
Access Street serving a maximum of 8 dwellings	none required
Park Edge Terrace	at least one side
Shared Accessway	none required

Street tree planting is to achieve a mature canopy coverage of at least 70% shading of the street and verge.

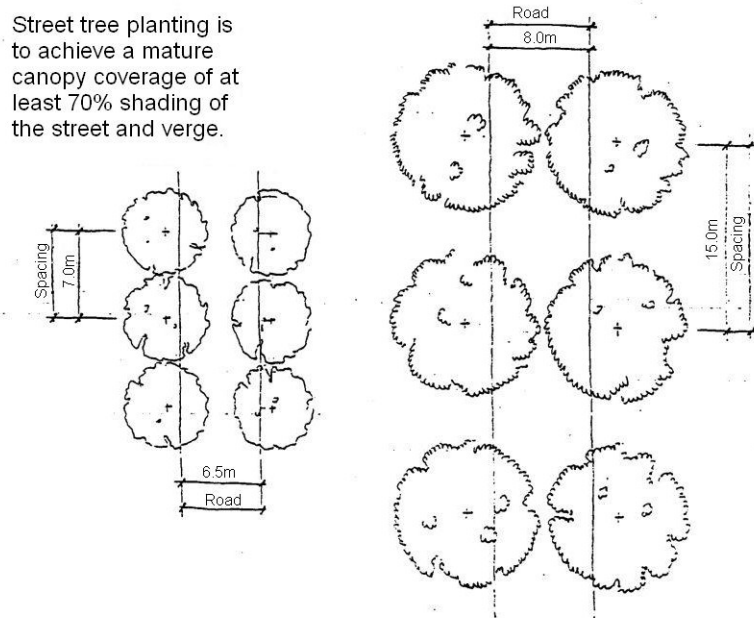

**Recommended Tree Spacing Options**

*Figure 16: Recommended tree spacing options*

3.2.4 Street Landscape

Street tree planting

**Objectives**

- O1. Utilise thematic street tree planning to complement the functional role of streets.
- O2. Ensure that separate species be utilised on separate street types
- O3. Encourage deciduous street tree planting on all streets.

### **Controls**

- C1. Street trees will be planted at a maximum spacing of 15m, measured from centre of trunk to centre of trunk.
- C2. At least one street tree shall be planted for each allotment.
- C3. Street Tree species should be selected such that they achieve the following:
  - super-advanced at planting (at least 200 litre);
  - possess suitable anti vandal treatment;
  - clean trunked to a height of at least 2m;
  - a mature height which is complementary to the scale of the street and the height of predominant buildings which have frontage to that street; and
  - a mature canopy diameter of at least 7m and which allows for 70% of the street and verge area.

### Street furniture

#### **Objectives**

- O4. Ensure there is to be a coordinated palette of street furniture utilised on the site.
- O5. Ensure the items will be selected to relate strongly to the heritage significance of the site.

#### **Control**

- C4. Items Detail of the palette of street furniture selected shall be submitted within a Landscape Master Plan for the site, which will address all elements of the public domain in a coordinated and holistic manner.

### Lighting

#### **Objectives**

- O6. Provide lighting to improve the level of safety within all streets.
- O7. Ensure light pole and luminaires shall be of a style, colour and form compatible with the heritage context of the site and the style, colour and form of other urban elements.
- O8. A strategy for lighting public spaces will be developed in conjunction with Council and will address the full range of issues including light type, appearance and spacing, as well as achievement of the relevant standards for acceptable ambient lux levels in public streets and spaces.



Street Landscape  
Lighting

*Figure 17: Street landscape - lighting*

**Controls**

- C5. Light poles shall be compatible with the pedestrian scale by virtue of their height and relationship to street dimensions.
- C6. Light poles shall be evenly spaced and contribute to establishing a regular pattern and rhythm in the street. Spacing of light poles is to be coordinated with the spacing of street trees.

Services

**Controls**

- C7. All services are to be located below ground, both within streets and between streets and individual dwellings.
- C8. All principal services are to be provided in accordance with the requirements of the responsible authority.

**3.3 Built form**

**Objectives**

- O1. Buildings should address and define the public domain, including streets and open space.
- O2. Buildings may be located up to the surveyed boundary of the Walpole Street Park Extension.
- O3. Development should form an organised and visually supportive and pleasing appearance to Walpole Street Park and Walpole Street. A high level of casual surveillance is to be afforded by the design of buildings. Service spaces and private open space areas are to be appropriately screened from public view.
- O4. Setbacks along each street should not be randomly composed. There should be a general consistency of building alignment and the street frontage.
- O5. Development of the site will be staged, commencing in the area adjacent to Walpole Street.

O6. Development of the site shall comprise a mix and variety of housing types throughout.

### 3.3.1 Building envelope and form

With the exception of the Heritage Precinct, the site will be developed for residential and activities ancillary to such residential development, such as open space and home offices.

Based on the current indicative Master Plan, this DCP envisages that the site will have a maximum density of 260- 280 dwellings, comprised of a mix of detached, semi-detached and medium density multi- unit housing. Council may at its discretion consider and approve a variation to the Master Plan where compelling economic, environmental or social grounds are present, and where the overarching objectives and principles of this DCP can be achieved.

#### Setbacks

#### **Controls**

- C1. Buildings must be set back from the property boundary by a distance which supports the achievement of the preferred building height to street width principle. (refer to section 3.3.1).
- C2. Building setbacks are described on the street sections appearing in Section 3.3. Specifically these correspond to a maximum of 4.5m to the principal facade.

#### Building height

- C3. The building height on any street must fall within the range defined by achievement of the preferred building height to street width principle (refer to Section 3.3.1).
- C4. Building height must conform with the Master Plan approved by Council. A revised Master Plan may be accepted and approved by Council from time to time.

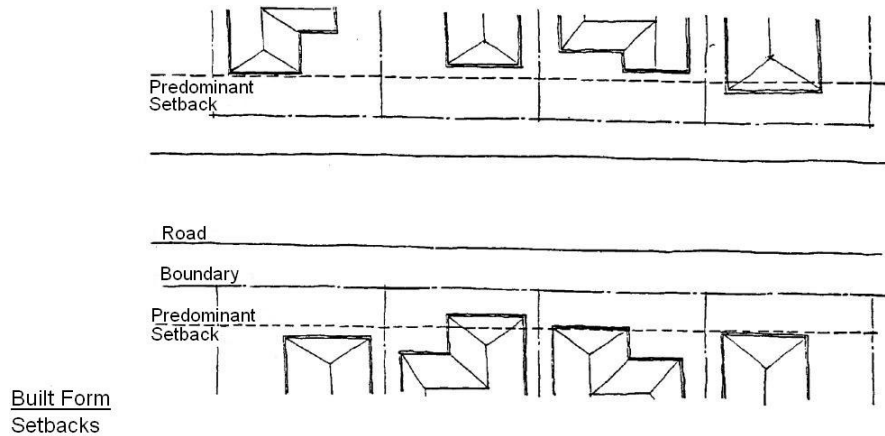

Figure 18: Built form setbacks

### Roof form

#### **Objectives**

- O1. Ensure there is a defined palette of roof colours and materials to be utilised throughout the DCP area.
- O2. Habitable use of roof space is encouraged in all residential development. Roof space is not counted as an additional storey for the purposes of this DCP.

#### **Controls**

- C5. Roofs shall be pitched at a slope which allows their habitable use and which is compatible with the pitch of roofs present on the heritage structures within the Heritage Precinct.
- C6. Roof form features such as hips, gables, chimneys etc. are encouraged in order to give greater visual interest and break up the bulk and mass of the roofscape
- C7. Eaves overhang should be considered in order to provide weather protection to walls.
- C8. Roofs should be of a colour and material which is compatible with important heritage buildings in the locality, and the surrounding urban context. Coloured corrugated steel and Marseilles tiles are encouraged due to their historic association with the site.

### 3.3.2 Massing and Fenestration

#### **Objectives**

- O1. The massing of buildings on the site should serve to fragment larger building forms into more human scaled components, in both vertical and horizontal planes.
- O2. Building facades are to be articulated and fragmented. They are to utilise building form, the play of light and shade, solid and void, and a variety of materials and elements in order to achieve visual interest and supportive relationship with the scale of pedestrians experiencing the urban environment both inside and outside the site.
- O3. Building facades are to exhibit a clear expression of “base”, “middle” and “top” components.

#### **Controls**

- C1. The horizontal bulk of buildings shall be downplayed through the use of strong vertical elements, particularly in cases where long walls will address the street.
- C2. There shall be regular spacing of solid elements and openings within the street facade of buildings.
- C3. Windows shall be vertical in proportion in order to reduce the apparent bulk of buildings.



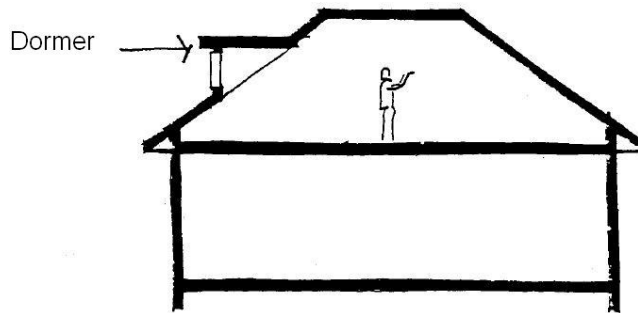

Habitable use of roof space is encouraged

*Figure 19: Habitable use of roof space*

### 3.3.3 Orientation and Solar Access

#### **Objectives**

- O1. While having regard to the orientation of the site, buildings are to be sited and designed in a manner which minimises their impact in terms of overshadowing.
- O2. Buildings are to be sited and designed such that a maximum of solar access is gained to internal living spaces and outdoor private open spaces.

#### **Controls**

- C1. North facing windows to main living spaces should receive a minimum of 4 hours direct sunlight during mid-winter while east and west facing windows should receive a minimum 2 hours direct sunlight during mid-winter. South facing windows in connection with main living areas should be minimised.
- C2. No building should unreasonably overshadow a public space or neighbouring private space between the hours of 10:00am and 2:00pm during mid-winter.

### 3.3.4 Building appearance

#### **Objectives**

- O1. The appearance of housing across the site should be coordinated such that there is a reasonable level of individual variety, within the context of achieving a compatible relationship between all buildings. There should be a mix of building forms.
- O2. Porches and verandahs are encouraged in order to provide shelter, identity, enhance casual surveillance of the street and provide the opportunity for increased community interaction.
- O3. Front yards are an important aspect for the setting and public appearance of buildings. Front yards should be seen as an opportunity to extend the quality of public landscape into semi-public areas.
- O4. Front yards should be designed and planted to support the architecture of the building as well as the overall landscape concept for the site.

### **Controls**

- C1. All new buildings must consider and respond supportively to buildings located in adjacent positions, as well as across the street. Consistency between ridge, eave and opening heights are important in this respect.
- C2. Building materials and colours selected and utilised on the site are to be coordinated throughout the site and are to be compatible with the heritage structures currently, or formerly, located on the site, and adjoining buildings. Generally, buildings of masonry and/or render construction with light colours of a neutral tone are preferred.
- C3. All housing shall have a clear and visible address point that is directly approached from the street. The front entrance pathway should not be shared with other buildings.
- C4. Entry spaces shall be designed in a manner that restricts direct views into the living spaces of dwellings.
- C5. Landscaping within front yards should enable high levels of casual surveillance of the street to be maintained.
- C6. Landscape details shall be submitted with each development application.

### 3.3.5 Specific Precinct Controls

#### Heritage Precinct Transition area

Building controls for the heritage precinct transition area apply to the area defined on Figure 20. Specifically, this area encompasses all land within 25m inside of the Heritage Precinct's northern, eastern and southern boundaries.

### **Objectives**

- O1. Provide an appropriate visual setting for heritage items;
- O2. Ensure that new development respects the established patterns in the former Goodlet and Smith Brickworks;
- O3. Ensure a harmonious and compatible relationship between the scale of heritage buildings and new development;
- O4. Ensure that new development respects the architectural style and character of the heritage precinct.

### **Controls**

#### Setting

- C1. Care should be taken in the placement of new buildings such that vistas of important heritage buildings are maintained along streets.
- C2. No part of any new development within the heritage precinct should project below the eaves overhang of a heritage item.
- C3. No new building should be located closer than 3m from a heritage item or its overhang, whichever is the greater.
- C4. New buildings within the heritage precinct should be designed in a manner compatible with the appearance of existing heritage items, without mimicking those heritage items.

### Scale

- C5. New buildings located within the heritage precinct should be compatible with existing heritage buildings. They should not visually dominate or compete with the scale of heritage items.
- C6. New development within the heritage precinct should not have more than 2 storeys of habitable space (exclusive of roofspace). Roof pitch and form should reflect that of adjoining heritage items
- C7. No portion of a new building located within the heritage precinct should extend above the ridge height of the Patent Kiln.
- C8. Simple roof forms, which do not compete with heritage buildings, are appropriate.



*Figure 20: Example of clearly defined entry*

### Materials

- C9. While not mimicking existing heritage buildings, new buildings located within the heritage precinct should adopt and utilise external materials and finishes complementary to the heritage fabric. These should be neutral tones
- C10. Front fences should be either low brick walls or incorporate a plinth, composed of simple rendered and painted brick. Exposed recycled brick is also appropriate.
- C11. Balconies and verandahs should incorporate only simple railings and balustrades, sympathetic with fencing.
- C12. Elaborate fretwork is to be avoided.

- C13. Gutters and flashings are to be of a traditional form. Fascia gutters are to be avoided.
- C14. New development proposed for the heritage precinct should be reviewed by Council's heritage advisor.

### 3.3.6 Development Adjacent to the Heritage Precinct

Building controls for areas adjacent to the heritage precinct apply to the area defined on Figure 21. Specifically, this area encompasses all land outside 25m of the Heritage Precinct's northern, eastern and southern boundaries.

#### **Objectives**

- O1. Provide an appropriate visual setting for heritage items.
- O2. Ensure that new development respects the established patterns in the former Goodlet and Smith Brickworks.
- O3. Ensure a harmonious and compatible relationship between the scale of heritage buildings and new development.
- O4. Ensure that new development respects the architectural style and character of the heritage precinct.

#### **Controls**

##### Setting

- C1. New development should be designed and sited in a manner which does not detrimentally effect the heritage significance of either the entire precinct, or individual elements within the precinct.
- C2. New development should be designed in a manner sympathetic to the appearance of existing heritage items.

##### Scale

- C3. The scale, bulk and height of new buildings located adjacent to the heritage precinct should be visually compatible with, and should not dominate, existing heritage items located within the precinct.
- C4. Any proposed building (or part of a building) located within 20m of an identified heritage item should not have more than 2 storeys of habitable space (exclusive of roofspace).
- C5. Roof forms which are sympathetic to those within the heritage precinct are encouraged.

##### Materials

- C6. While not mimicking existing heritage buildings, new buildings located adjacent to the heritage precinct should adopt and utilise external materials and finishes complementary to the heritage fabric. These should be light colours and neutral tones
- C7. Front fences should be either low brick walls or incorporate a plinth, composed of simple rendered and painted brick.
- C8. Balconies and verandahs should incorporate only simple railings and balustrades, sympathetic with fencing.

- C9. Elaborate fretwork is to be avoided.
- C10. Gutters and flashings are to be of a traditional form. Fascia gutters are to be avoided.

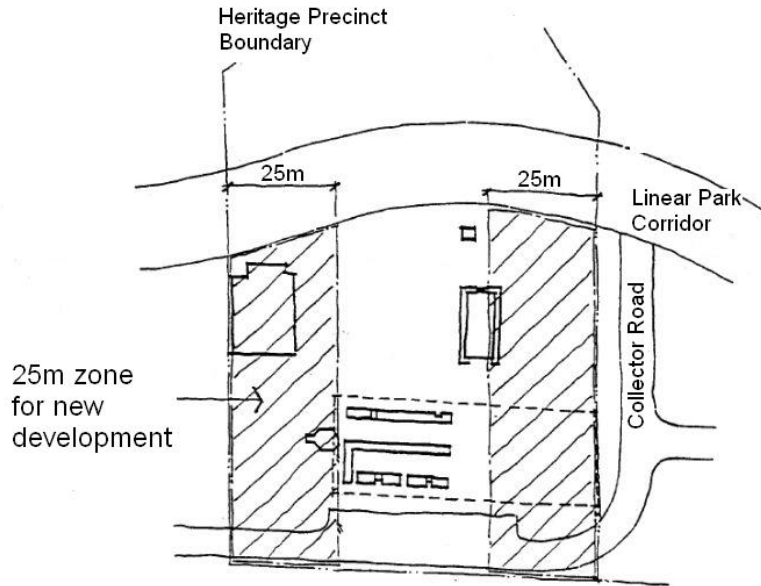

Built Form  
Heritage Precinct Transition Area

Note: Location of Collector Road is indicative only. Alignment is subject to further design and confirmation.

Figure 21: Built form – heritage precinct transition area

### 3.3.7 Development Adjacent to Walpole Street

#### Objectives

- O1. Ensure buildings experiencing dual frontage to both Walpole Street and streets internal to the site, present a suitable facade to Walpole Street and foster a suitable relationship to the public domain external to the site.
- O2. Provide high levels of casual surveillance to Walpole Street.
- O3. Ensure there is a balance between the requirements of privacy for dwellings and the creation of a suitable interface with Walpole Street.

#### Controls

- C1. Service areas fronting Walpole Street are to be adequately screened such that they are obscured from pedestrian view.
- C2. Building services such as water heaters, rainwater tanks etc may not be located on facades facing Walpole Street.
- C3. Boundary fencing must be coordinated along the length of Walpole Street.
- C4. Boundary fencing may be no higher than 1.8m in height.

- C5. Boundary fencing should utilise a variety of materials and/or incorporate substantial articulation and modulation in order to create visual interest. The creation of recessed bays, incorporating planting is encouraged in this respect.
- C6. Buildings with frontage to Walpole Street shall include adequate measures to ameliorate noise impacts generated from both passing traffic and industrial activities located opposite. These measures, and their appropriateness, must be demonstrated through submission of an acoustic assessment.

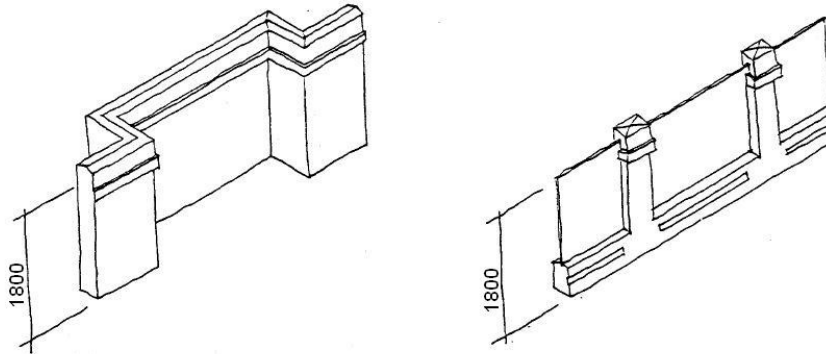

Built Form  
Potential Fencing Types for  
Walpole Street.

*Figure 22: Built form – potential fencing types for Walpole St*

### 3.3.8 Development Adjacent to the Main Southern Railway and Adjoining Industrial Development

#### **Objectives**

- O1. Ensure buildings located adjacent to the Main Southern Railway present a suitable facade to the railway alignment in order to enhance the visual perception of the site.

#### **Controls**

- C1. Service areas fronting the railway alignment are to be adequately screened/obscured from view.
- C2. Building services such as water heaters, rainwater tanks etc should not be located on facades facing the railway alignment.
- C3. No building should be located within 3m of the railway alignment or the common boundary of adjoining industrial development.
- C4. All buildings located adjacent to the railway alignment and/or adjoining industrial activities must include adequate measures to ameliorate noise impacts generated from the railway and/or industrial activities. These measures, and their appropriateness, must be demonstrated through submission of an acoustic assessment.

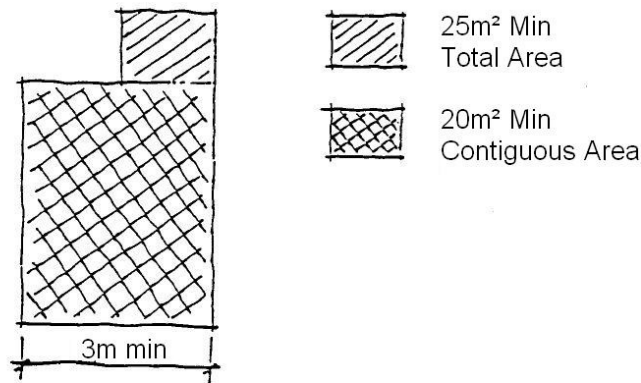

**Built Form**  
On Site Open Space

Figure 23: Built form – on-site open space

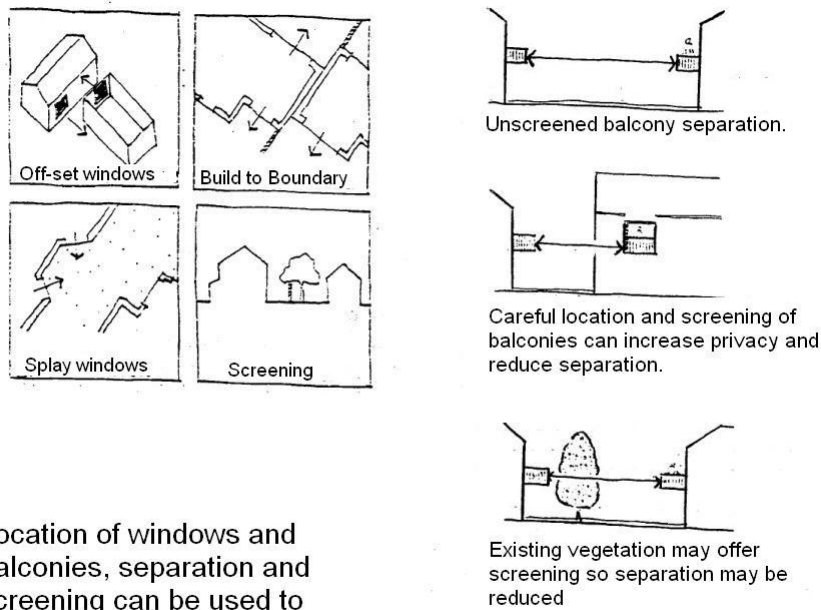

Location of windows and balconies, separation and screening can be used to ensure adequate visual privacy.

Figure 24: Examples of adequate visual privacy

### 3.3.9 Site development issues

#### On site open space

C1. All dwellings are to be provided with private open space which achieves the following principles:

- amenity, slope and dimensions suited to the needs of users;
- adequate privacy for residents;
- access to adequate direct sunlight, particularly during winter months; and
- be adjacent and/or visible from the main living areas of dwellings.



- C2. Each dwelling must be provided with a minimum area of private open space consisting of one of the following attributes:
- ground level area totalling 25m<sup>2</sup>, having a minimum contiguous area of 20m<sup>2</sup> and a minimum dimension of 3m; or
  - a balcony, located immediately adjacent to the main living area, with a minimum area of 6m<sup>2</sup> and a minimum dimension of 1.5m (only applicable for blocks of units).

Privacy and overlooking

*Visual privacy*

- C3. Direct overlooking of main internal living areas and private open spaces of adjacent properties should be minimised through building location, the offset positioning and design of windows, the positioning and design of balconies and/or the use of screening devices where necessary.

*Acoustic privacy*

- C4. Site layout and building design minimises the transmission of external noise to habitable rooms through attention to:
- siting of buildings;
  - internal room layout;
  - location of private open space;
  - location and design of windows; and
  - building construction methods.
- C5. Habitable rooms, particularly bedrooms, shall be separated from significant noise sources.

*Casual surveillance*

- C6. Casual surveillance of streets and other public spaces is to be maximised through the following design principles:
- living areas should be located in areas which directly overlook public spaces;
  - windows should be located such that they provide for casual surveillance of public spaces; and
  - planting located in semi-public and private areas should be selected such that a generally unobstructed view of public spaces may be available.



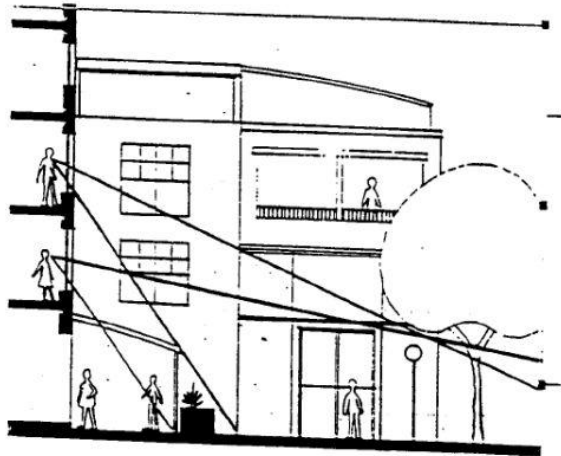

The location of living spaces and position of windows should maximise potential for casual surveillance of streets and public spaces.

*Figure 25: Location of living spaces*

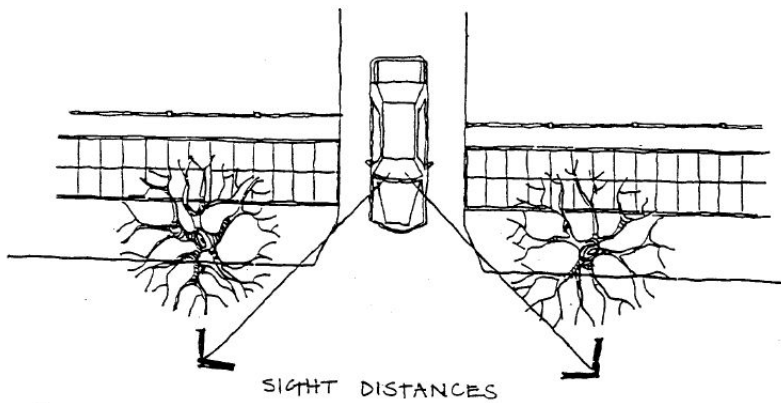

*Figure 26: Site distances*

Access and parking

C7. Parking areas, driveways and street access design are to comply with the relevant Australian Standards. Refer to Part G of *Cumberland Development Control Plan 2021*.

*Car parking*

C8. On site car parking for residents is to be provided according to the following:

*Table 3: Parking provision*

Development type	Parking provision
Apartments	1 space per apartment, dedicated to that apartment; and 1 space per 5 apartments for visitor parking.
Houses, Duplexes, Terrace Houses	At least 1 space undercover; and at least 1 additional space on site.

C9. Bicycle parking is to be provided in multi- unit buildings at a rate of 1 space per 3 apartments.

*Driveways*

- C10. Where paving materials are utilised, these should be:
- in materials, other than plain concrete, and of colours which complement the site;
  - the use of colour and materials should be coordinated across the site and be selected from a defined palette for the site; and
  - of adequate strength and non-slip qualities.

*Access for the street*

C11. Double driveways should be no greater than 5m in width. Single car driveways should be no greater than 3m in width.

*Flooding and stormwater disposal*

- C12. Habitable floor levels of buildings are to be located at least 300mm above the 1 in 100 year ARI flood level.
- C13. Basement level carparks are to incorporate measures such that they are able to remain flood free for the 1 in 100 year ARI flood event.
- C14. Connection of developments to the street or piped stormwater disposal system.

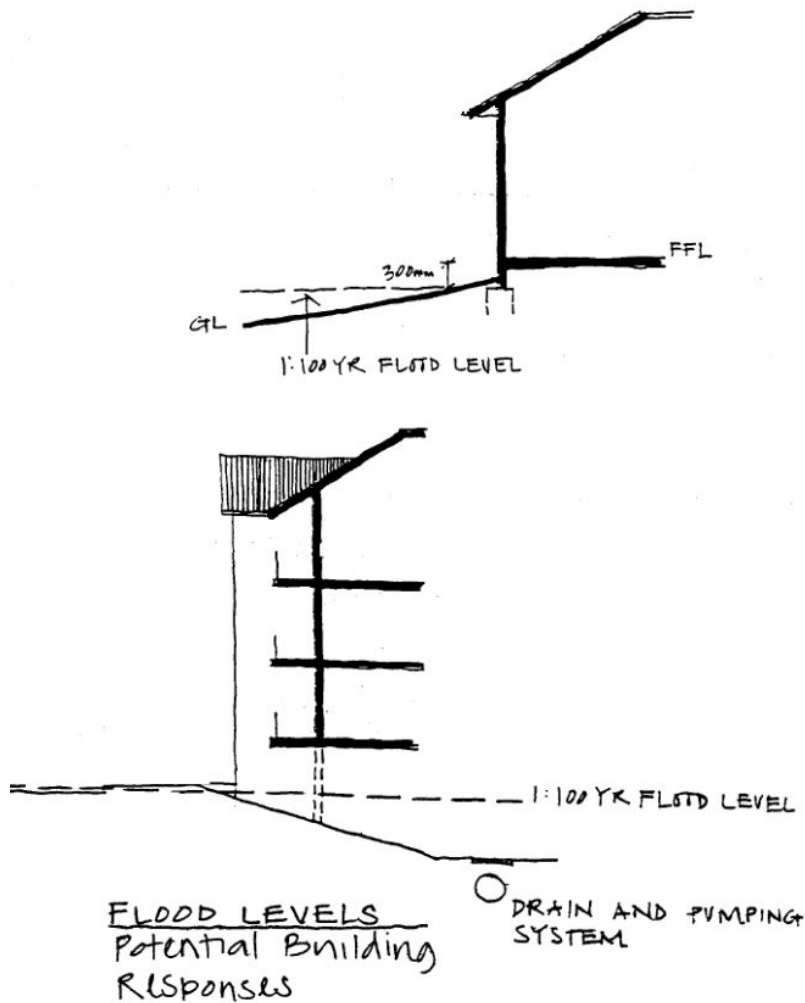

Figure 27: Flood levels and potential building responses

### 3.4 Disabled access and adaptable housing

The term adaptable housing implies that flexibility is built in at the design stage in order to allow dwellings to be modified when and if, changing circumstances dictate. In this way, adaptable housing achieves principles of robustness in the urban environment. Similarly, adequate provision of disabled access to buildings provides for greater equity and recognises the diversity of potential user groups in the community.

#### Controls

##### Disabled access

- C1. Access into or around detached dwellings, townhouses and duplexes is to be flat, or gently sloping. The majority of all ground floor dwellings (detached, terrace houses and duplexes) should be capable of adaptation to allow barrier free access.
- C2. All public spaces should be designed in a manner which allows their equitable use by disabled residents and visitors.

Adaptable housing

- C3. Development of the site is to achieve the provision of a total of 26 adaptable dwellings, in accordance with AS 4299-Adaptable Housing (Class C). This standard is based on a rate of provision of 1 adaptable unit per 10 dwellings.

### 3.5 Ancillary issues

#### 3.5.1 Energy efficiency

**Objectives**

- O1. Ensure the design and layout of housing on the site facilitates the achievement of appropriate levels of energy efficiency.
- O2. Encourage building design to minimise fossil fuel energy use and to maximise use of natural ventilation, daylight and solar energy.
- O3. Encourage buildings to utilise layouts that minimise winter heat loss and make use of solar energy for heating wherever possible.
- O4. Ensure buildings are designed to minimise excessive exposure to summer sun.

**Controls**

- C1. Windows shall be located to facilitate thermal control.
- C2. Building materials should be durable and require low levels of maintenance.
- C3. Materials, which have a higher thermal mass value (e.g. bricks, concrete and stone), shall be utilised where they may benefit thermal control and energy efficiency of a building.
- C4. Buildings are to utilise materials which possess a low level of embodied energy.
- C5. Buildings are to maximise the use of recycled and recyclable materials. In particular, building materials currently located on the site should be reused wherever possible.
- C6. Building fitouts shall utilise energy efficient appliances where available.
- C7. All dwellings are to achieve a minimum 3.5 star rating under the *Housing Energy Scheme* (NatHERS) Compliance with this requirement is to be demonstrated by the applicant as part of the development application submission.

#### 3.5.2 Garbage disposal and waste storage

**Controls**

- C1. Appropriate space shall be provided within each dwelling for the temporary storage of garbage and recyclables.

- C2. A waste storage area is provided on site, is accessible to users and is of a size that caters for the following requirements:

Tables 4a and 4b: Waste storage requirements

Capacity (litres)	Height (mm)	Width (mm)	Depth (mm)
120	930	480	550
240	1080	575	730
1100	1465	1360	1220

Dwelling type	Provision
Detached House	1 x 240litre bin 1 x 240litre split recycling bin
Villa or Townhouse	1 x 240litre bin 1 x 240litre split recycling bin
Apartments	1 x 1100litre container per 8 units
Apartments (not exceeding 10 units)	1 x 240litre split recycling bin
Apartments (>10 units)	1 x 240litre paper recycling bin per 6 units 1 x 240litre comingled bin per 6 units

- C3. The location and design of waste storage facilities is complementary to the architecture, landscape and street frontage of the development.

### 3.5.3 Boundary fencing

#### Objectives

- O1. Use fencing to enhance an image/perception of quality and provide appropriate levels of privacy.
- O2. Use front fences to provide a suitable transition between the public domain and semi-public areas located within individual allotments.
- O3. Discourage high front fences which are not transparent

#### Controls

- C1. Detached, Terrace houses Duplexes:
- the option of no front fence is encouraged;
  - front fences must not exceed 1.5m from ground level (excluding piers); and
  - front fences must be highly transparent.
- C2. Apartment Buildings:
- front fences are required for all buildings in order to provide an appropriate transition between public and semi-public space;
  - front fences must not exceed 1.8m (excluding piers); and
  - front fences must be highly transparent.
- C3. Side and rear fencing should be generally no higher than 1.8m. They should provide an adequate level of privacy to private open spaces and should be consistent with building design and where visible from the street.



Appropriate boundary fencing for detached dwellings



Appropriate boundary fencing and landscape treatment for apartment buildings

Figure 28: Boundary fencing and landscaping

### 3.5.4 Street numbers

#### Control

- C1. All street numbers must be clearly visible from the principal street frontage.

### 3.5.5 Garages and outbuildings

#### Controls

- C1. Garages and outbuildings are to comply with all other relevant sections of this DCP, Specifically, Building Envelope, Building Form, Building Appearance and Specific Precinct Controls where applicable.
- C2. Garages and outbuildings should be designed to complement the architecture of the main building to which they are related.
- C3. All garages and carports must be set back behind the main front facade of the building to which they are related.

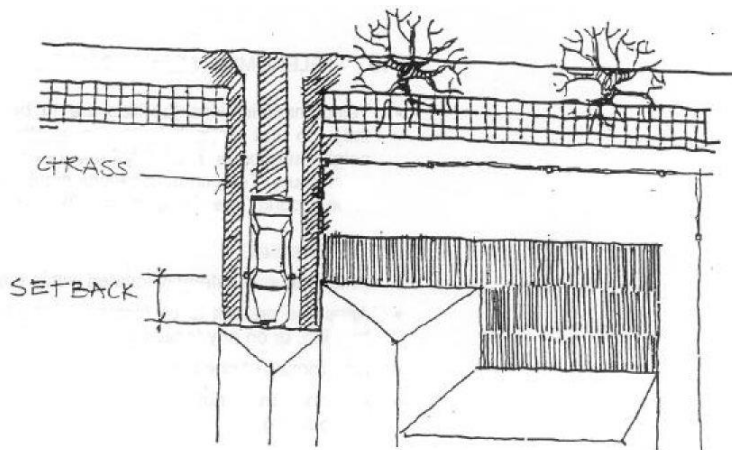

Figure 29: Garage setback

### 3.5.6 Clothes drying areas

#### **Controls**

- C1. Clothes drying areas are to be screened from both the street and adjoining properties.
- C2. Clothes drying areas are to be easily accessible from dwellings and should not dominate the form and availability of private open space within a development.

### 3.5.7 Storage areas

#### **Control**

- C1. Adequate storage space is to be provided for all residential development and may be provided either within a dwelling or within common areas such as parking garages.

### 3.5.8 Telecommunications facilities

#### **Controls**

- C1. Telecommunications facilities are to be located such that they do not detract from the aesthetic appeal of the neighbourhood or adversely impact on the visual amenity of neighbours.
- C2. Telecommunications services are to be located underground (see also section 3.3.6).

### 3.5.9 Antennae

#### **Controls**

- C1. Antennae are preferably located within the roof cavity.
- C2. Antennae are not to be located on the front facade of any building, or on any facade facing Walpole Street.
- C3. A maximum of one antenna is permitted per building.
- C4. Antennae must not extend above the uppermost ridge line of a building.

### 3.5.10 Cabling

#### **Control**

- C1. All cabling for the purposes of pay TV etc must be located below ground.

### 3.5.11 Satellite Dishes

#### **Controls**

- C1. No satellite dish is to be located on the front facade of a building, or be visible from a public street.
- C2. Satellite dishes are to be located below the ridgeline (or parapet) of the roof.
- C3. A maximum of one satellite dish is permitted per building.

This page has been left intentionally blank.





CUMBERLAND  
CITY COUNCIL

# PART F1-14 PEMULWUY RESIDENTIAL

This page has been left intentionally blank.

# 1. Introduction

## 1.1 Land to which this Part applies

Land to which this Part applies includes land identified as land within the residential precinct of Pemulwuy as shown in Figures 1 and 2.



Figure 1: Pemulwuy North sub precinct



Figure 2: Pemulwuy South sub precinct

## 2. Vision and General Objectives

### 2.1 Vision

The vision for Pemulwuy is for a high quality public domain, incorporating the natural characteristics, ecology and heritage of the site. Sustainable development principles underlie the proposed urban outcome. While most of these objectives apply at the scale of precinct and subdivision planning, many can be applied also at the lot scale.

### 2.2 General Objectives

#### Objectives

- O1. Ensure that development within the Pemulwuy Residential Precinct is primarily used for residential purposes and associated facilities.
- O2. Provide for a range of housing types, including secondary dwellings, dual occupancies, attached dwellings, semi-detached dwellings and multi dwelling housing, in areas well served by public transport and near local shops.
- O3. Allow people to carry out a reasonable range of activities from their homes while maintaining neighbourhood amenity.
- O4. Allow for a variety of small scale local non-residential uses that primarily serve local residents and are compatible with the character of the living area.
- O5. Allow home occupations where such activities are unlikely to adversely affect the living environment of neighbours.
- O6. Prohibit development that is of an offensive, hazardous, noisy, intrusive or environmentally inappropriate nature.
- O7. Allow for local open space that is accessible and well located, that promotes the use and enjoyment of local open space for both residents and the workforce, that may include elements of the natural environment, and that provides for active and passive recreation.

## 3. Specific objectives and controls

### 3.1 Public open space

#### 3.1.1 Public domain open space strategy

##### **Objectives**

- O1. Develop a strong and high quality network of public open spaces that includes town squares, parks and streets.
- O2. Develop a public domain that links the Pemulwuy community together through open space corridors.
- O3. Design the public domain at a scale that encourages pedestrian use, and is well addressed by surrounding development.
- O4. Provide areas of high amenity for the local community to focus upon and use.
- O5. Design the public domain within the site (comprising parks, riparian and drainage corridors, water bodies, paths, cycleways and streets) to create a unique setting and exemplar for development throughout Pemulwuy.
- O6. Ensure that the design of these facilities achieves longevity of the service life of the assets, and ease of maintenance of the public domain and open space areas and the improvements located in them.
- O7. Reinforce within the mixed-use centre near the Driftway Drive/Butu Wargun Drive intersection civic, cultural and recreational facilities supported by workplaces, shops and a variety of housing types.
- O8. Consider the Biodiversity Management Measures.

##### **Controls**

- C1. Locate parks to achieve views from and towards Prospect Hill.
- C2. Locate parks for the amenity of the residents and to be easily accessed.
- C3. Design parks for the site appropriate to their place and role.
- C4. Design open spaces which:
  - are generally edged by streets. Where this does not occur, the public/private interface shall be suitably delineated;
  - are within an easy 5 minute walk from most residences;
  - are well distributed and part of a public domain network;
  - provide a distinctive focus for local neighbourhoods;
  - allow for a range of passive recreational activities;
  - are part of a hierarchical public domain network of parks and streets which interpret points of difference within the site, related to topography, site features, orientation, and aspect; and
  - may be reinforced with associated community facilities.
- C5. Landscape open space areas using anti-graffiti treatment and materials, including wall treatment to masonry surfaces.

- C6. Design the Greystanes Creek Woodland Park and the Northern Bushland Park to provide access for Council's maintenance equipment through the provision of appropriate access points.

### 3.1.2 Trees and ecological habitats

#### **Objectives**

- O1. Create neighbourhood identity using indigenous tree species.
- O2. Enhance and maintain biodiversity by complementing other conservation initiatives.
- O3. Use locally indigenous plant species, including threatened and regionally significant species, in drainage areas, streetscapes and open spaces.
- O4. Conserve threatened species populations and their habitats.
- O5. Create fauna movement corridors within the site and link to external ecological resources (where practicable allowing for other site uses).
- O6. Reduce water and fertiliser demand.
- O7. Maintain tree hazard at acceptable levels.
- O8. Create an environmental corridor along Greystanes Creek.
- O9. Retain and add to existing trees on Prospect Hill, consistent with the Prospect Hill Conservation Management Plan, thereby forming large stands of trees to provide a visual buffer to development when viewed from the top of Prospect Hill.

#### **Controls**

- C1. Manage trees in accordance with Part G of this DCP.
- C2. Ensure that the tree network and structure will provide a coherent wildlife corridor throughout the site from adjacent sites.
- C3. Retain existing healthy trees unless there are clearly justifiable reasons for their removal and alternatives have been considered (see Part G).
- C4. Retain where possible existing trees consistent with Figure 1 (Pemulwuy South) and Figure 2 (Pemulwuy north), subject to future detailed design. With regard to the latter and in the interest of the development generally, retain as many trees as possible under the direction of a qualified arborist.
- C5. Retain where possible trees located in areas depicted as public open space, especially where species from the Cumberland Plain Woodland and Sydney Coastal River Flat Forrest suite of species are to be preserved and augmented. For example, stands or groups of trees are located predominantly around the existing creek line, and are to be retained as part of the riparian zone adjacent to the creek where possible.
- C6. Wherever possible, to use correct genotypes and collect seed from the local trees. This applies throughout the public domain. In some locations, exotic species can be used for landscape accent and shade.
- C7. Clear weeds and non-natives as part of a program to re-establish native plants.

- C8. Retain and add to existing trees on Prospect Hill, consistent with the Prospect Hill Conservation Management Plan, thereby forming large stands of trees to provide a visual buffer to development when viewed from the top of Prospect Hill.
- C9. Replace the predominant pine forestation of Pemulwuy with native planting.
- C10. Preserve and protect any scarred tree located in Pemulwuy, in consultation with Aboriginal/ Archaeological advice.
- C11. Ensure tree species selection is consistent with Figure 1 (Pemulwuy North) and Figure 2 (Pemulwuy South).
- C12. Ensure that the hierarchy of street trees reflect the scale of the streets, design intent, safe usage of trees and building size.
- C13. Retain scattered trees of landscape and ecological value in the private domain.
- C14. Apply the following process for tree selection and establishment for the site, whichever is the lesser:
- select the most appropriate tree species based on the suitability of the site; in particular, species which are resilient to storm damage (given appropriate establishment and maintenance);
  - ensure that tree plantings mature with the highest possible root and structural strength by appropriate plant selection, procurement, site preparation, establishment and maintenance; and
  - design the public domain to incorporate sufficient space to allow for tree establishment, where proposed. This includes the provision for the development of deep structural roots.
- C15. Manage retained native trees within the public domain by integrating periodic hazard assessment (undertaken by a qualified arborist) with the implementation of appropriate arboricultural treatments to maintain tree hazard at acceptable levels. Ensure frequency of hazard assessments is 12 monthly or at a time when significant changes in the use of the site are proposed, whichever the lesser.
- C16. Apply the following process for tree removal from the site:
- where possible, trees that may need to be removed are to be transplanted in the core riparian zone or outer protection zone of the Greystanes Creek Corridor;
  - in addition, trees to be removed are those that fall within proposed road corridors, within or close to building foot prints or those identified as structurally unsound, dangerous or inappropriate for retention as outlined in the arborist report. The total extent of these additional trees to be removed is to be determined as part of the design development phase of the project;
  - confirm the final extent of trees to be removed by a qualified arborist; and
  - ensure tree removal involves the complete removal from site of the tree and root system. Roots less than 50mm diameter may remain.

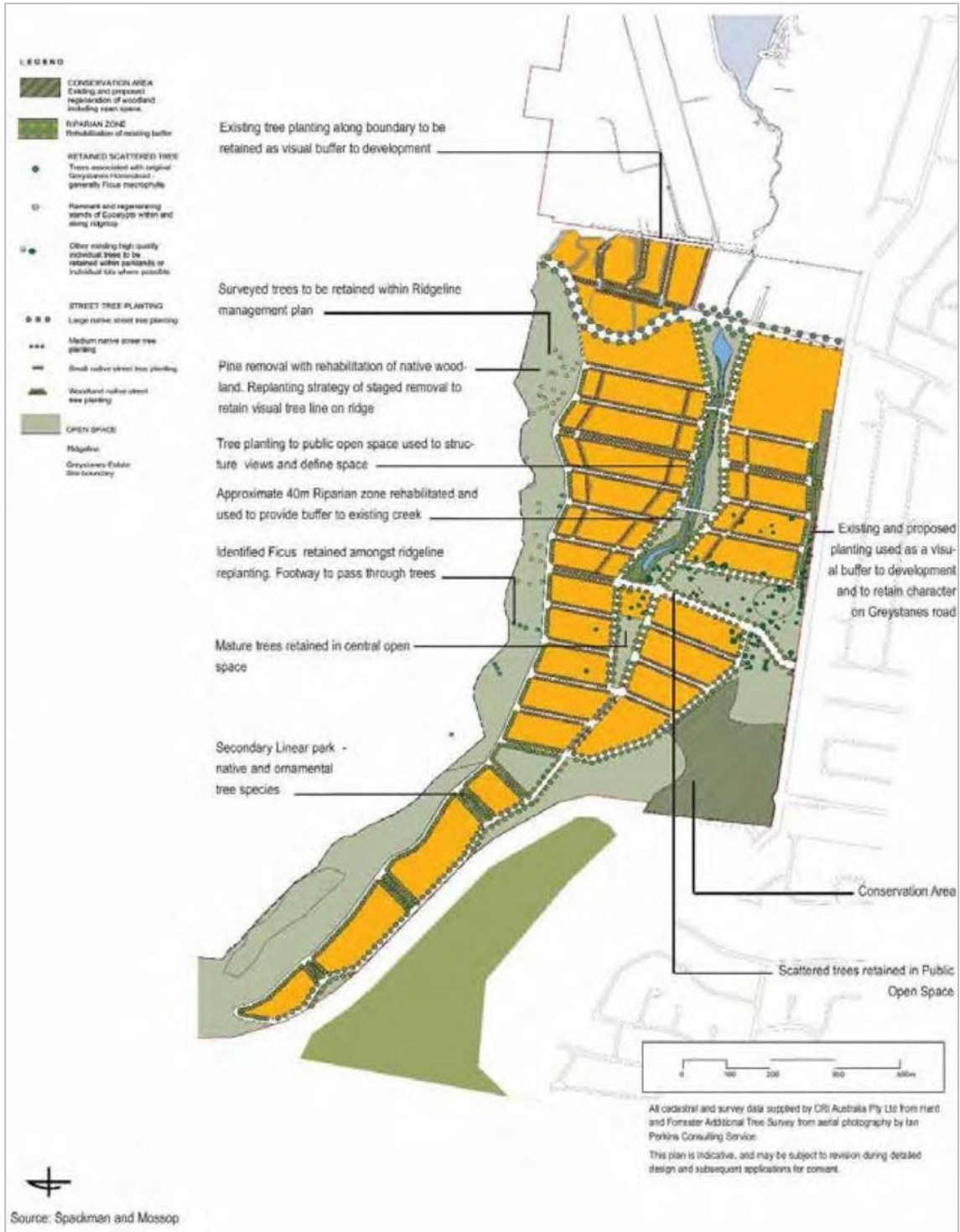

Figure 3: Trees and ecological habitat



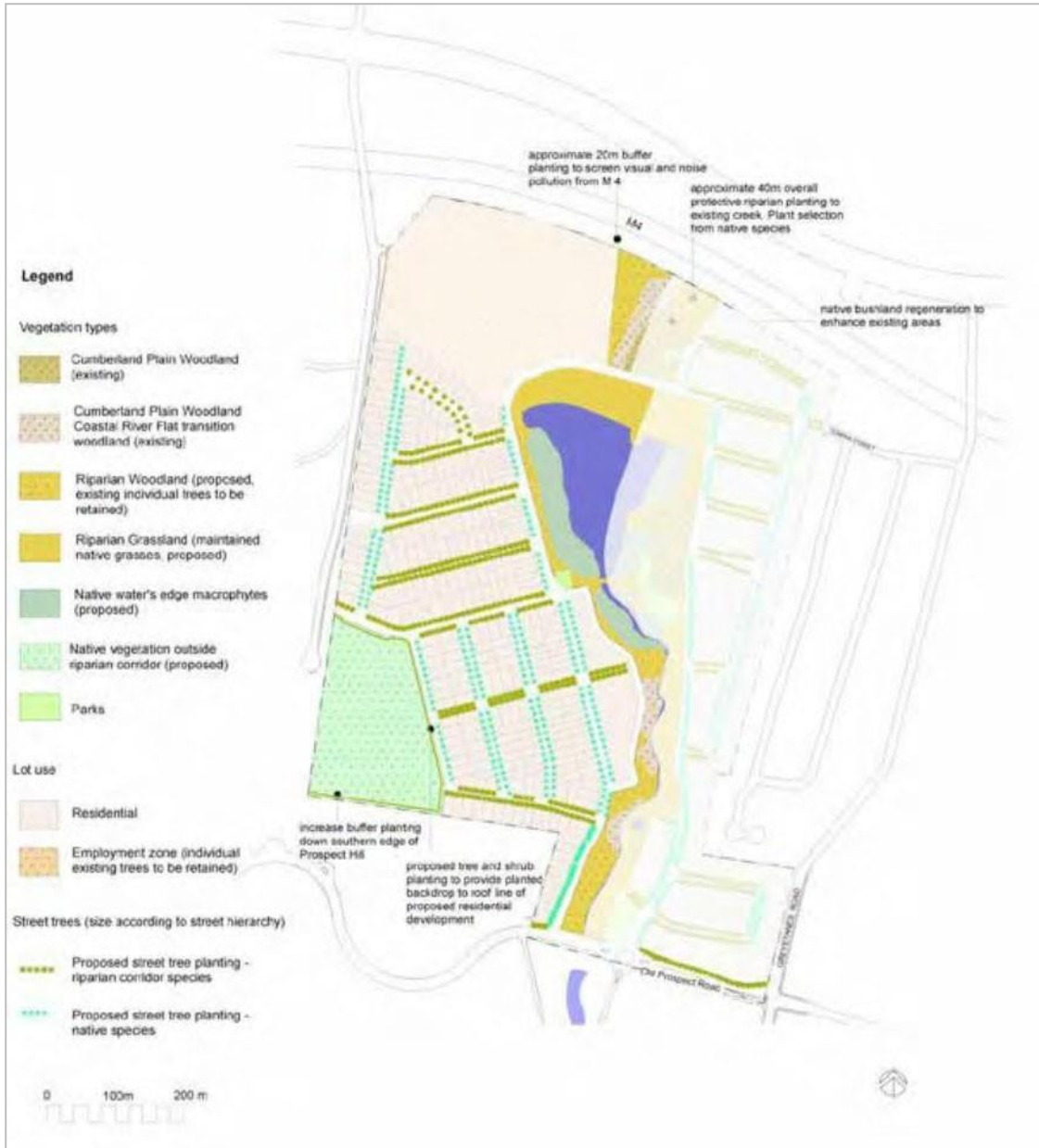

Figure 4: Proposed vegetation strategy



Figure 5: Existing individual tree strategy

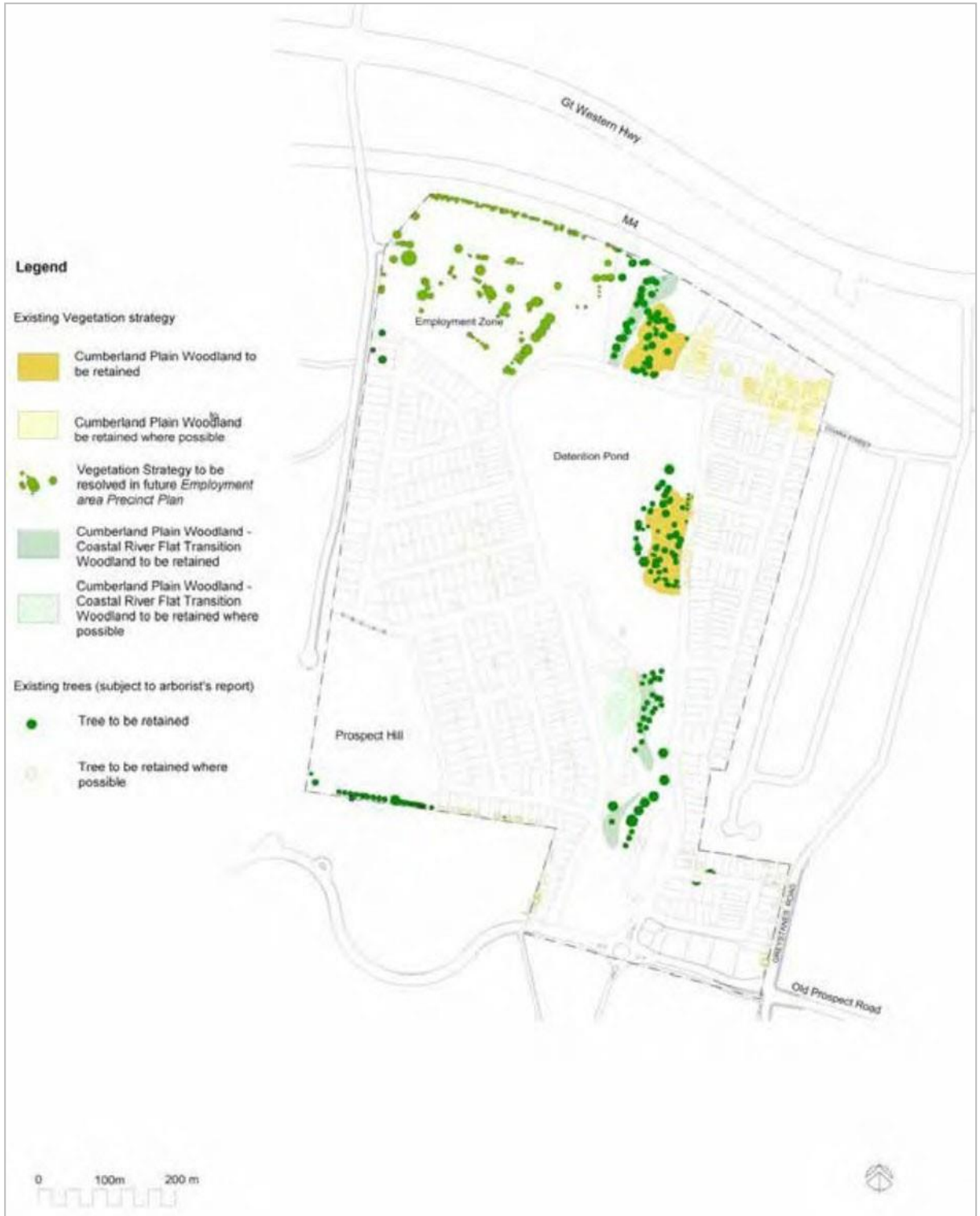

Figure 6: Existing vegetation/tree strategy

### 3.1.3 Public Open Spaces – Pemulwuy North

#### *Greystanes Creek Woodland Park*

#### **Objectives**

- O1. Provide the Greystanes Creek Woodland Park as a linear Environmental Protection area, with some open space to protect and enhance the ecological riparian outcomes on the site.
- O2. Service the community's recreational needs through provision of distinct areas.
- O3. Locate the Woodland Park centrally and overlooked on both sides by houses to improve passive surveillance.
- O4. Visually link the park clearly with the adjacent street system, enhanced by tree avenues and vistas to control views and enclose spaces.
- O5. Enhance biodiversity and ecological processes on the site through the provision of a vegetated environmental protection zone.

#### **Controls**

- C1. Greystanes Creek Woodland Park has been completed, and provides:
  - a vegetated riparian zone (consisting of a core riparian zone and an outer protection zone) in accordance with the agreement reached between Stockland and the Department of Planning (refer to Figure 7);
  - rehabilitation of the existing core environmental protection zone and outer protection zone and identified areas of Sydney Coastal River Flat Forest and Cumberland Plain Woodland;
  - a diversity of local native trees, shrubs and groundcover species in the core riparian zone, as detailed in the Vegetation Management Plan/Bushland Management Plan for the Greystanes Creek Woodland Park;
  - a coherent wildlife corridor linking surrounding open spaces and ecological habitat;
  - lighting at key points;
  - sedimentation ponding;
  - open amenity areas, such as a picnic area on the eastern side of the lake, seating and small areas of hard standing/paving;
  - unstructured recreation areas;
  - dedicated pedestrian/cycle paths, generally in the outer protection area; and
  - public art at appropriate locations and of an appropriate nature.





Figure 7: Riparian corridor plan - Greystanes Creek Woodland Park

### Prospect Hill State Heritage Register area

The Prospect Hill State Heritage Registered area is listed on the NSW State Heritage Register (SHR) and the Register of the National Estate. The area also includes land along the ridgeline south of Butu Wargun Drive, plus an identified curtilage.

The part of the SHR area south of Butu Wargun Drive, is addressed in the section on Prospect Hill under Public Open Space Precincts of Pemulwuy South.

### **Objectives**

- O6. Retain the open grass hill character as open space and preserve the distinctive ridgeline.
- O7. Consult with local community groups to ensure that the future proposal reflects the historical relevance of the past.
- O8. Because the topography of the ridgeline lends itself to prime viewing, to locate these within the pedestrian network, consistent with the *Prospect Hill Heritage Landscape Study and Plan* and the *Prospect Hill Heritage Interpretation Plan*.

### **Controls**

- C2. Ensure all development within Prospect Hill is informed by the following documents:
  - *Prospect Hill Conservation Management Plan* (Conybeare Morrison; 2005);
  - *Prospect Hill Heritage Landscape Study and Plan* (NSW Government Architect's Office; 2008); and
  - *Prospect Hill Heritage Interpretation Plan* (MUSEscape; 2009).

### Village Green

"Village Green" is located adjacent to the north-west corner of Butu Wargun Drive and Driftway Drive, Pemulwuy. This location is central to the residential developments and community and retail facilities of Pemulwuy for optimum accessibility.

### **Objectives**

- O9. Provide landscape and heritage interpretation which protects and interprets the natural, Indigenous and cultural significance of the Prospect Hill SHR area.
- O10. Open views in to the Greystanes Creek Woodland Park from the entry road, adding to the feeling of a well connected open space network.
- O11. Provide a hub for activity, close to the village centre.

### **Controls**

- C3. Village Green has been completed, and provides:
  - a paved area for seating/meeting with an open pavilion structure;
  - shade coverage and a play area for toddlers and young children allowing for parental supervision;
  - amenity lighting at key points;
  - low profile fencing around some areas of the park;
  - a large area of flat maintained turf for informal and unstructured recreation (approximately half a playing field for informal ball games). The topography is graded around the edges to define the recreation space and the interface with the road; and

- public art at appropriate locations and of an appropriate nature.

#### Northern Bushland

The “Northern Bushland” area is located north of the detention basin within the identified potential dam break flood hazard zone. The area contains the creek and identified ecological communities/trees of varying quality. An opportunity arises to create public open space in the form of unstructured open space with an ecological feel. See the Objectives below for three distinct bushland character types required.

#### **Objectives**

- O12. Retain and enhance the existing creek line as a natural system through a vegetated riparian zone.
- O13. Service the community’s passive recreational needs.
- O14. Provide a safe recreational environment.

#### **Controls**

- C4. Vegetate in accordance with the Vegetation Management Plan/Bushland Management Plan prepared for the Northern Bushland Park.
- C5. In the vegetated riparian zone, provide a diversity of local native trees, shrubs and groundcover species.
- C6. Retain existing trees, and regenerate by planting further native bushland species.
- C7. Provide a 2.5-3m pedestrian/cycleway through the area. Locate the pathway to facilitate a rider experience of the range of habitat types and the sequence of open and enclosed spaces.
- C8. Where practicable, provide pedestrian/cycle links to the north using existing culverts.
- C9. Within the open space area, provide activity nodes for a playground, fitness equipment/ sculpture/ seating and for environmental interpretation.
- C10. Regenerate areas of bushland to protect existing trees and provide a buffer zone to the M4.
- C11. Provide limited open maintained grassland with pedestrian access in accordance with Figure 8.
- C12. Provide adequate lighting at key points.

*Note: Refer to Figure 8 for the agreed riparian corridor for the Northern Bushland Park and Figure 9 for indicative concept plans.*



Figure 8: Concept plan for the Northern Bushland Park





Figure 9: Concept section A for the Northern Bushland Park

### Lakeside area

#### **Objectives**

- O15. Provide visual amenity for residents of Pemulwuy.
- O16. Enhance the existing flora and fauna species.
- O17. Sensitively locate circulation and viewpoints in order to minimise disturbance while providing the opportunity to observe and appreciate wildlife.
- O18. Service the community's recreational needs.
- O19. Provide a safe recreational environment.

#### **Controls**

- C13. Create viewpoints overlooking the lake, linked by a cycle/pedestrian route around it.
- C14. In the design of embankments and their surrounds, ensure safety around the water's edge. Fully investigate safety issues relating to the dam.
- C15. Locate the cycle and pedestrian route along the top of the dam wall offering views up and down the creekline.
- C16. Provide macrophyte zones for water quality treatment with baffling structures to direct flow.
- C17. Provide adequate lighting at key points.
- C18. Provide public art at appropriate locations of an appropriate nature.

*Note: Refer to Figure – 11 for an illustrative view and concept plan of the area.*



Figure 10: Perspective of southwest area of the lakeside



Figure 11: Concept plan for the southwest area of the lakeside

Neighbourhood pocket parks (Pemulwuy North)

**Objectives**

- O20. Provide unstructured open spaces.
- O21. Provide key pedestrian nodal points and connections.
- O22. Provide a safe recreational environment.

**Controls**

- C19. Define park tree avenues with the main aspect being in an easterly direction.
- C20. Plant shrubs and trees of an ornamental character with larger species providing shade.
- C21. Where the park is fronted by a pedestrian footpath, clearly delineate the public/private domain through the use of front fences.
- C22. Use front verandas or porches in adjacent development to encourage use and overlooking.
- C23. Create opportunities for play settings and seating.
- C24. Provide appropriate lighting.
- C25. Consider public art as part of the overall design.

*Note: Refer to s 12 and 13 for an illustrative view and concept plans*





Figure 12: Perspective of Neighbourhood Pocket Park

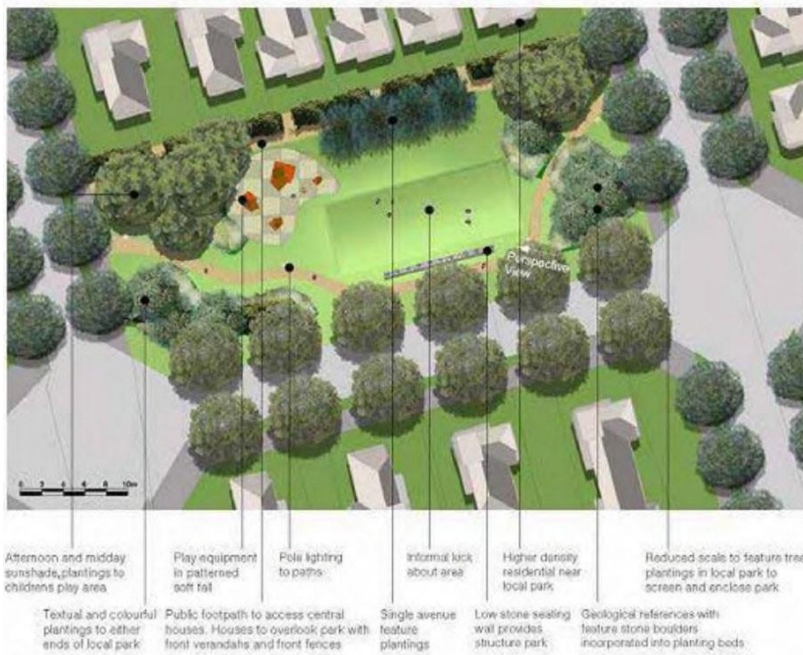

Figure 13: Concept plan for Neighbourhood Pocket Park

### 3.1.4 Public Open Spaces – Pemulwuy South

The Public Open Space Precincts of Pemulwuy south of Butu Wargun Drive (with a small exception in the north-west corner) are identified below in Figure 14.

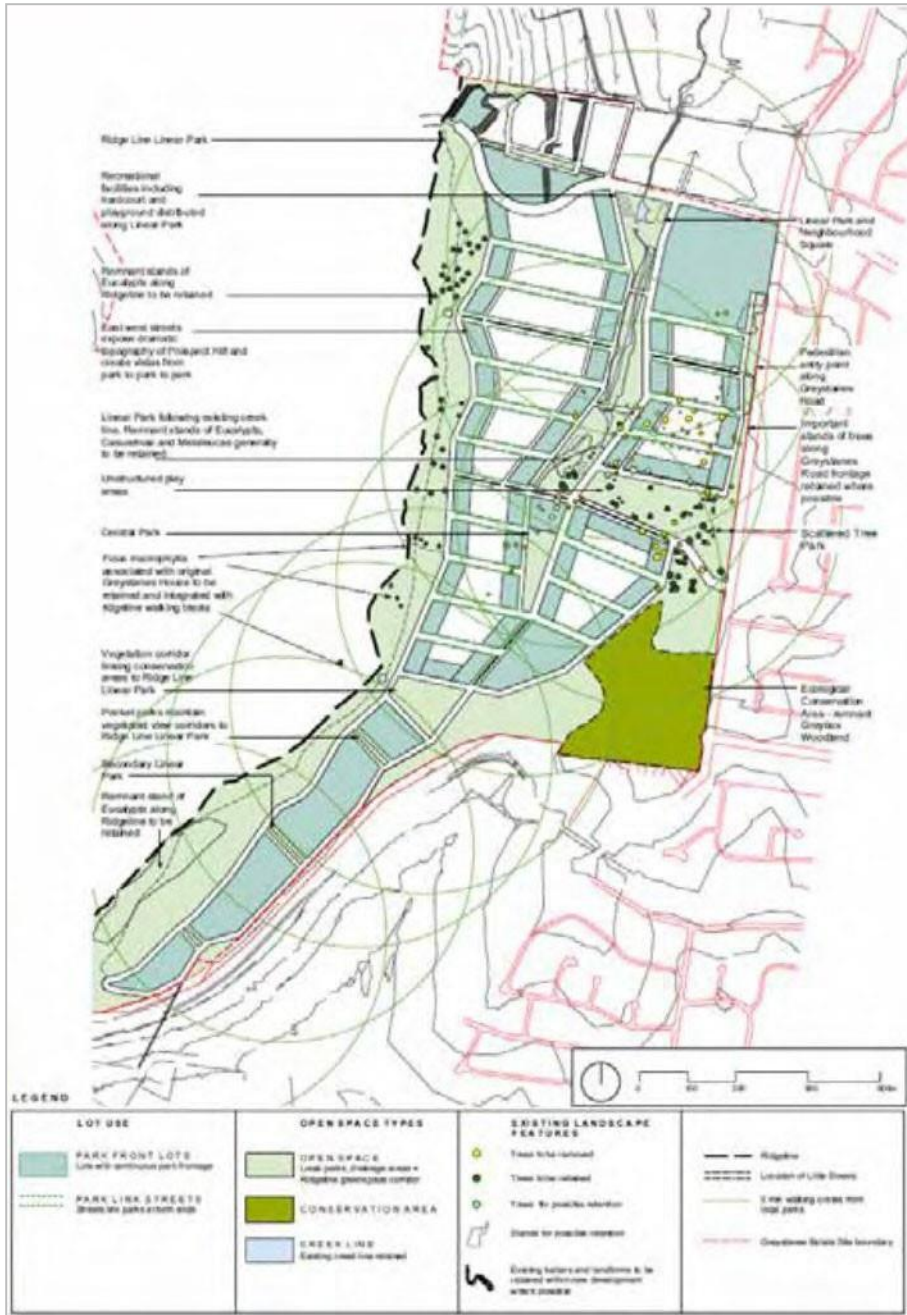

Figure 14: Open space precinct of Pemulwuy South

Greystanes Creek linear park (south of Butu Wargun)

**Objectives**

- O1. Service the communities' recreational needs by providing three distinct areas of varying size:
  - A neighbourhood square;
  - riparian buffer/open amenity; and
  - structured recreation.
- O2. Make strong visual links with the adjacent street system, enhanced by tree avenues and vistas to control views and enclose spaces.

**Controls**

- C1. Within Nelson Square, provide for:
  - a paved area for seating/meeting;
  - external café seating;
  - ornamental tree and shrub planting;
  - historical installation/public art;
  - interactive edge to existing creek line;
  - development as a visual gateway into site from east/west link street;
  - shade coverage and play area for toddlers and young children allowing for parental supervision; and
  - lighting at key points.
- C2. Ensure that the riparian buffer/open amenity zone dominates the secondary area, defining the extent of open space and creating a distinct character to the park by providing:
  - areas of open space for informal/passive recreation;
  - seating;
  - areas of hardstanding/paving;
  - connectivity through the internal area of the park to pedestrian/cycle links with the wider Estate; and
  - rehabilitation of existing riparian buffer zone.
- C3. For structured activity areas, provide two half-size multi-use hardcourts that are central to the overall layout of development. Use strategic buffer planting to reduce noise and visual disturbance to immediate residential areas.

Central park

**Controls**

- C4. In relation to the Linear Park, ensure that Central Park:
  - is a smaller scale suitable for passive recreation;
  - provides a space to service the mixed use buildings and bus stop;
  - has potential for external café restaurant seating;
  - provides a combination of paved areas, maintained grass and ornamental planting to create a character of small scale; and
  - contains high quality eucalyptus trees that add a distinct character and are pivotal to the overall design of the central park.

Scattered tree park

**Objectives**

- O3. Retain wherever possible the existing trees of ecological or landscape values in this area.
- O4. Form a link between the creekline vegetation and the narrow strip of Cumberland Plain Woodland which borders Greystanes Road.
- O5. Protect known sites of Aboriginal heritage.
- O6. Provide an unstructured recreation facility for residents.
- O7. Maintain and enhance strong links to Grey Box Reserve.
- O8. Ensure that activities and uses of this park do not impinge on Grey Box Reserve.
- O9. Generally, to provide low-key picnic and recreation activities for in this park.

**Controls**

- C5. Ensure that new vegetation is primarily Cumberland Plain species.
- C6. Enclose the open space to the eastern end with areas of regenerated bushland.
- C7. Plant and screen known aboriginal sites to protect their location.
- C8. Provide continuous shared access from Linear Park through Scattered Tree Park to Grey Box Reserve.

Secondary linear parks

**Objectives**

- O10. Locate secondary parks close to residences.
- O11. Provide for unstructured activities.
- O12. Create a pedestrian/cycle link from the Prospect Hill ridgeline to the north-south connector road.
- O13. Provide visual amenity in the public domain.

**Controls**

- C9. Locate secondary parks within five minutes walking distance of the immediate community.
- C10. Define parks by tree avenues, with the main aspect being in an easterly direction. (Figure shows a concept design for these parks and Figure shows a section through the Secondary Linear Park.)
- C11. Enhance aspect by framing and opening up views in an easterly direction.
- C12. Plant shrubs and trees of an ornamental character.



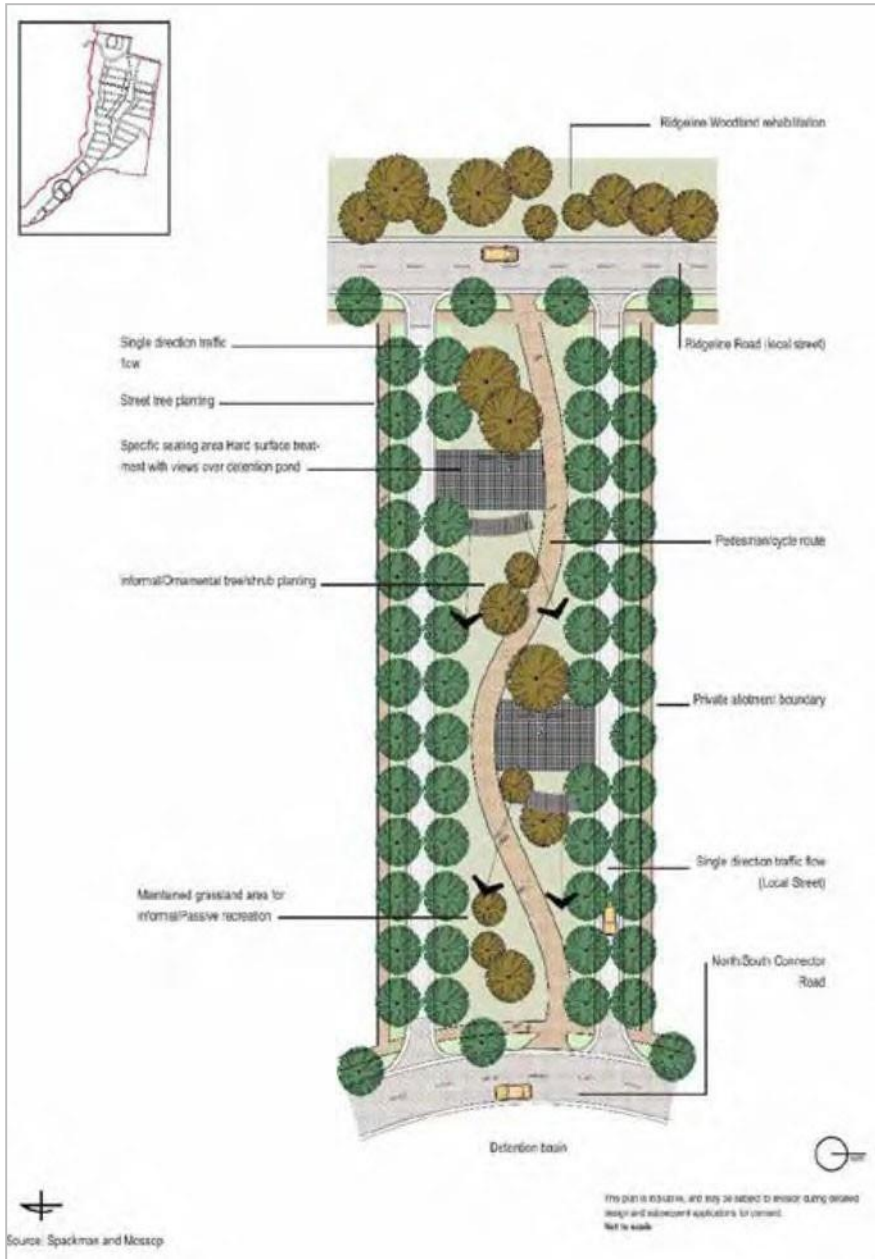

Figure 15: Secondary linear Parks



### Prospect Hill park

The Prospect Hill State Heritage Registered area is listed on the NSW State Heritage Register (SHR) and the Register of the National Estate. The area also includes land along the ridgeline south of Butu Wargun Drive, plus an identified curtilage.

The part of the SHR area north of Butu Wargun Drive, is addressed in the section on Prospect Hill under Public Open Space Precincts of Pemulwuy North.

### **Objectives**

- O14. Provide landscape and heritage interpretation which protects and interprets the natural, Indigenous and cultural significance of the Prospect Hill SHR area.
- O15. Consult with local community groups to ensure that development reflects the historical relevance of the past.
- O16. Because the topography of the ridgeline lends itself to prime viewing, to locate these within the pedestrian network, consistent with the Prospect Hill Heritage Landscape Study & Plan and the Prospect Hill Heritage.

### **Controls**

- C13. Ensure all development within Prospect Hill (Marrong Reserve) is to informed by the following documents:
  - Prospect Hill Conservation Management Plan (Conybeare Morrison; 2005);
  - Prospect Hill Heritage Landscape Study & Plan (NSW Government Architect's Office; 2008); and
  - Prospect Hill Heritage Interpretation Plan (MUSEcape; 2009).

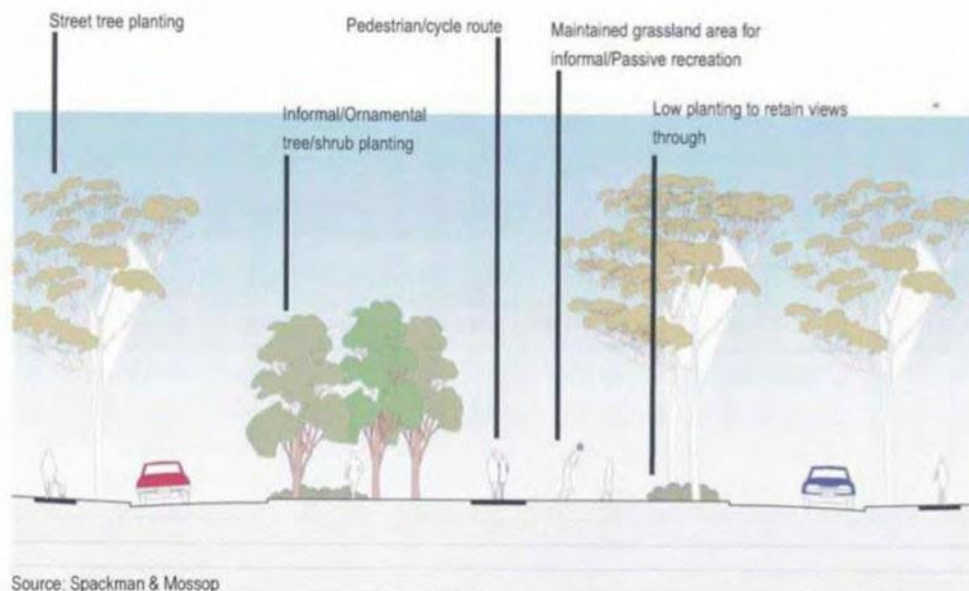

Figure 16: Section through secondary linear park

### 3.1.5 Wet Basins

#### Objectives

- O1. Integrate water storage requirements within Pemulwuy South into a safe and natural setting.
- O2. Design the wet basin and surrounding area as a feature within the landscape.
- O3. Retain long distance views from the Secondary Linear Parks and promote casual surveillance.
- O4. Be accessible for passive recreation only.
- O5. Ensure safety is of prime importance.

#### Controls

- C1. Control water levels to ensure safety is preserved.
- C2. Secure deeper areas of the basins with a buffer of planting.
- C3. Ensure that edge treatment of the Basins is natural, with riparian planting, shrubs and trees.
- C4. Use local stone to set the pond into the existing topography.
- C5. Keep vegetation to a minimum where it interferes with long distance views from the Secondary Linear Parks and casual surveillance.

*Note: Figure and Figure provides an illustrative layout to the wet basins in the Southern Residential Lands*

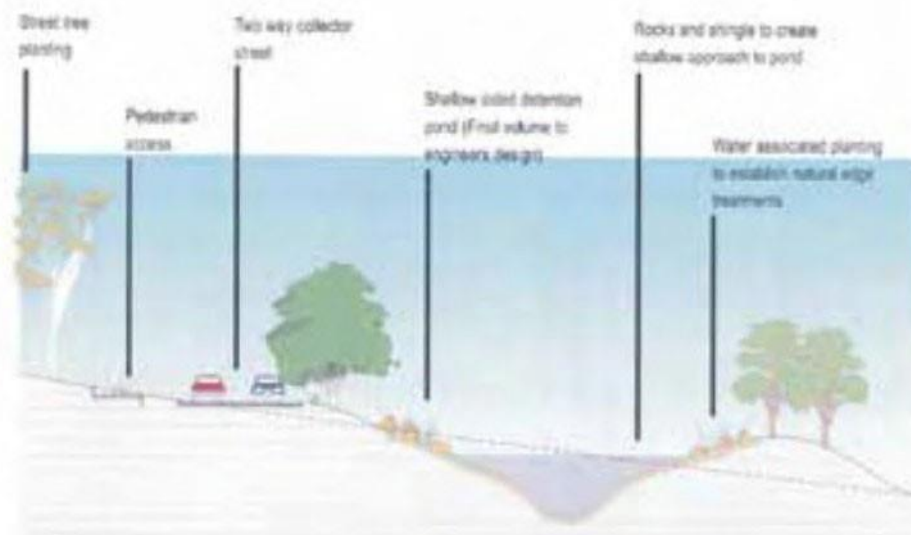

Figure 17: Section B-B through wet basin

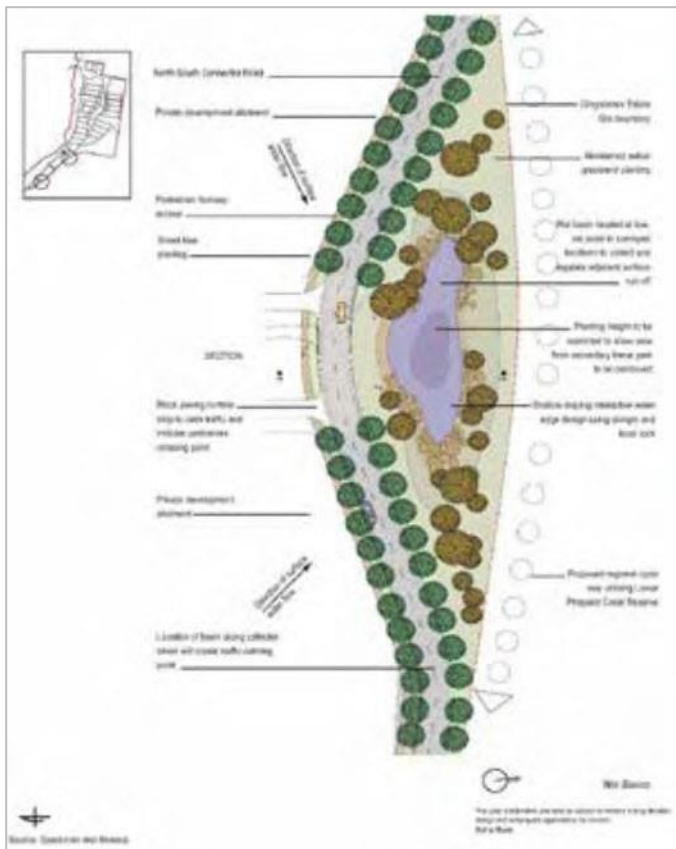

Figure 18: Wet basin landscape treatment

### 3.1.6 Grey Box Reserve

#### Objectives

- O1. Conserve areas of high Potential Archaeological Deposits (PAD) and significant known artefacts or sites.
- O2. Define the boundary of the bushland conservation area known as Grey Box Reserve.
- O3. Incorporate areas of potential archaeological deposits and representative elements of the cultural landscape.
- O4. Manage the impacts from recreation and access on the bushland ecology.
- O5. Educate the local community in the pre-European history of the site.

#### Controls

- C1. Retain the area on site that most closely reflects the pre-European cultural landscape. Refer to Figure 19.
- C2. Limit recreational opportunities in the conservation area to passive activities.
- C3. Prepare a plan of management detailing measures to appropriately manage the Aboriginal cultural heritage. This should be prepared in consultation with the local Aboriginal community, the National Parks and Wildlife Service (NPWS) and Council. An

open artefact scatter representative of those identified elsewhere within the survey area, is shown in Figure 19 (Archaeological and Excavation Sites).



Figure 19: Bushland conservation area (Grey Box reserve)

**Note:**

- Council will not consent to development within the area indicated by blue dashed line in Figure 19 below without the concurrence of the Heritage Office. Refer to Figure 20 below under Solar Access and Sun Shading for further Lot.

**Orientation Principles**

- Develop a suitable educational program in consultation with the local Aboriginal community, National Parks and Wildlife Service and Council.
- Ensure that interpretive signs and other educational material are general in nature and do not draw attention to any physical aspects of the Aboriginal cultural heritage section through the wet basin.

## 3.2 Subdivision

### 3.2.1 Geotechnical Considerations

#### Objectives

- O1. Characterise site subsurface and geotechnical conditions based on test pit, borehole and laboratory data.
- O2. Provide pavement thickness designs for the proposed road network. A range of subgrade conditions have been considered including the use of lime stabilised subgrade to control potential excessive in situ moisture at the time of construction and to improve subgrade strength and reduce pavement cover requirements.
- O3. Provide guidance on earthworks requirements for proposed roads, residential lots and other civil works.
- O4. Provide assessment of lot classifications in accordance with AS2870-1996 “Residential Slabs and Footings”, together with recommendations on footings.
- O5. Ensure that all designs for roads and pavements consider the impacts of soil salinity, soil sodicity, sulphate aggressive soils, dispersive soils and saline groundwater.
- O6. Minimise disturbance to natural hydrological systems as a result of development, and to provide for appropriate management of land affecting the process of salinisation, or affected by salinity.
- O7. Prevent damage to buildings and infrastructure caused by salinity.

#### Controls

- C1. Develop road and pavement designs in accordance with the guidelines contained in the *Site Investigations for Urban Salinity, Roads and Salinity and Building in a Saline Environment* (DIPNR, 2003).
- C2. Design pavements on natural subgrades for CBR values in the expected range from about 2.5% to 4.5%, for which pavement thicknesses of about 300mm to 500mm would be required. Excessively wet natural subgrade may necessitate a further 250mm to 400mm thickness of subgrade replacement. Review engineering plans for each staged development and prepare a specific pavement design in accordance with Council's requirements.
- C3. Design pavements on natural subgrade stabilised by the in situ addition of lime for a CBR value of 10%, for which pavements thickness of about 250mm to 300mm would be required. Provided lime stabilisation is carried out to a depth of about 300mm to 350mm, it is anticipated that the need for conventional subgrade replacement (of excessively wet subgrade) would be unlikely.
- C4. Carry out earthworks for pavement construction, lot filling and other civil works in accordance with Council's specifications for Subdivisions and Development and/or *AS3798-1996 Guidelines on Earthworks for Commercial and Residential Developments*. Compaction control for these works should also be in accordance with the above Standard.
- C5. Assess AS2870 classifications for all lots and document findings in a report prepared by the geotechnical consultant towards the completion of each staged development.

C6. Minimise the impact of the proposed development on local and regional salinity processes.

C7. Minimise the impact of salinity on the proposed development.

### 3.2.2 Block and Lot Structure

#### **Objectives**

- O1. Design blocks and subdivisions that support and relate to the public domain.
- O2. Efficiently utilise developable land.
- O3. Provide for a diversity of housing choice.
- O4. Minimise disturbance to natural hydrological systems as a result of development.
- O5. Provide for appropriate management of land affecting the process of salinisation, or affected by salinity.
- O6. Prevent damage to buildings and infrastructure caused by salinity.
- O7. Design building blocks and lots to minimise cut and fill and retaining walls.
- O8. Consider all relevant site constraints, including location of services, easements, available access, topography, privacy and solar orientation.
- O9. Create a comfortable home, structure blocks to maximise the natural characteristics of an allotment. This includes taking into account:
  - aspect,
  - views,
  - existing slope,
  - trees,
  - predominant breezes, orientating living rooms to the north, and
  - drainage and flooding potential.
- O10. Subdivide blocks to create a lot structure that anticipates the siting of dwelling types that support the public domain.
- O11. Subdivide blocks to create a lot structure that anticipates the siting of dwelling types incorporating solar design principles.
- O12. Increase the efficiency of dwellings and external spaces and minimise residual parcels.
- O13. Maintain views to and from Prospect Hill.

#### **Controls**

- C1. Design subdivision blocks which:
  - value and efficiently use urban land - do not create difficult residual spaces and awkward boundary conditions;
  - are capable of flexibility for future development involving re-subdivision or amalgamation;
  - actively seek to ensure retention of all existing trees wherever possible; and



- create a block structure that orientates streets to link public open spaces. For example, implement the principles shown in Figure 16 to accommodate pedestrian travel in the public domain, with urban street block dimensions generally within the following maximum dimensions:
    - Length - less than 250m or,
    - Depth - less than 80m deep or less than 40m deep in conjunction with little streets.
- C2. Maximise the number of allotments in areas with the greatest amenity including those areas close to retail/community facilities, public transport and along park frontages.
- C3. Maximise the number of allotments addressing streets in the southern part of each block to increase the number of dwellings with northerly aspect to rear living rooms and gardens. Refer Figure 21 below.
- C4. Design lots which:
- have a generally orthogonal lot geometry to increase efficiency of dwellings and external spaces and minimise residual parcels;
  - Accommodate a variety of housing types to suit different household mixes and sizes;
  - reflect landscape features such as slope and waterways by addressing storm water run off, the opportunity for views and breezes and reduction in the height of retaining walls;
  - achieve dwelling units oriented for optimal solar access, including the use of eaves, window awnings and screens that contributes to a comfortable living environment;
  - maximise the number of allotments addressing streets to the south to increase the number of dwellings with northerly aspect to rear living rooms and gardens;
  - align the setback to the front of the dwelling with the facades of adjoining dwellings on the street; and
  - create lots within the Pemulwuy South precinct in accordance with the Lot Size and Frontage Width ranges for each dwelling type as specified for the Pemulwuy South precinct.
- C5. Design corner lots to address both street frontages.
- C6. Maximise solar access with either east-west lots or north-south lots, with special attention to lots that are on the south side of the street.
- C7. For East-West orientated Lots in particular:
- provide generally wider frontages to lots addressing the Prospect Hill to accommodate dwellings with modulated side setbacks and courtyards to maximise solar access;
  - provide generally wider frontages to lots addressing streets to the north to accommodate passive solar design in future dwellings;
  - provide uniform scale, height, setbacks and consistent architectural character to dwellings addressing open spaces to reinforce the public domain;
  - create corner lots that accommodate secondary street setbacks and allow dwellings to reinforce their prominent position and address both primary and secondary street frontages; and
  - within the Pemulwuy South precinct, generally provide wider frontages to lots addressing Greystanes Road and Hyland Park where the Estate meets existing suburban areas.

C8. For North-South orientated Lots in particular:

- coordinate cut and fill and finished levels between lots to provide equitable access to solar access and outlook;
- massing of dwellings should respond to existing site falls and topography;
- locate parking areas on the southern side of dwellings where possible; and
- create corner lots with adequate dimensions that allow dwellings to accommodate secondary street setbacks, respond to both street frontage and mark important corners in the subdivision.

*Notes:*

- *Applications for subdivision of land into less than 300m<sup>2</sup> lots parcels are Integrated Housing developments, and are subject to provisions set out in the following section on Coordinated Development and Integrated Housing Sites; and*
- *Topographically steep areas are generally considered sites for Coordinated Development and are subject to provisions set out in the following section on Coordinated Development and Integrated Housing Sites.*
- *Applications for Coordinated Development are subject to provisions set out in the following section on Coordinated Development and Integrated Housing Sites.*



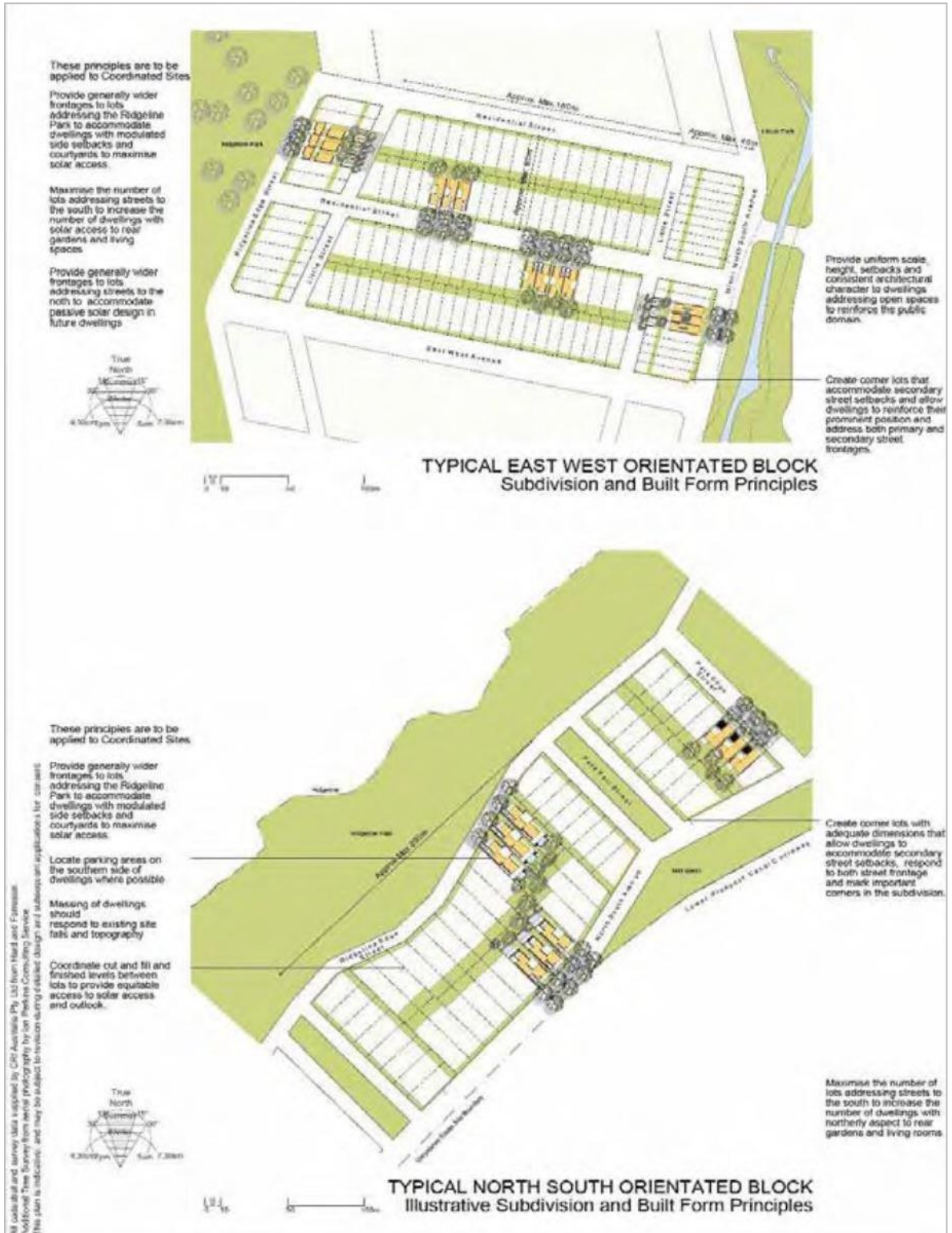

Figure 20: Typical subdivision.

### 3.2.3 Cut and Fill at Subdivision

#### **Objectives**

- O1. Minimise cut and fill.
- O2. Coordinate cut and fill between all lots to provide equitable access to sunlight, outlook and privacy to all dwellings.
- O3. Ensure unimpeded natural groundwater flow.
- O4. Protect the geotechnical integrity of lots, including adjoining lots.

#### **Controls**

- C1. On cross-sloped land, ensure side boundary cut and fill (and associated retaining wall) at subdivision stage is no greater than 900mm (Pemulwuy South).
- C2. On front-to-back-sloped land, ensure rear boundary cut and fill (and associated retaining wall) at subdivision stage is no greater than 1.5m, to reduce front to back lot grades. No further rear boundary retaining walls are permitted (Pemulwuy South).
- C3. Limit retaining walls in the front setback to 1m in height, or tiered in sections of no more than 1m with at least 0.5m width landscaped separation between wall tiers.

#### Coordinated development and integrated housing sites

Topographically steep areas indicated in Figures 21 and 22 are considered sites for Coordinated Development.

Integrated Housing developments are applications for subdivision of parcels of land into less than 300m<sup>2</sup>.

#### **Objectives**

- O1. Ensure that the design of dwellings on steep sites, noise affected and small lots is carried out in an architecturally consistent and integrated manner.
- O2. Ensure that the key focuses are a high quality streetscape, a strong neighbourhood character and residential amenity.
- O3. Ensure that the built form responds to the topographical constraints, particularly the slope and orientation of each allotment.
- O4. Ensure that new development provides appropriate residential amenity, particularly with respect to visual privacy, and the relationship between dwellings.
- O5. Ensure that new development provides appropriate residential amenity, particularly with respect to solar gain to each allotment and the relationship between dwellings.

*Note: Address these objectives during the subdivision application stage in particular.*

#### **Controls**

- C1. Design dwellings on Integrated Housing sites as a unified group of buildings with consistent alignments, articulation, material selection and architectural character.

- C2. For Coordinated Developments, coordinate side boundary setbacks, building envelopes, finished floor levels and cut and fill between all lots to provide equitable access to sunlight, outlook and privacy to all dwellings at the subdivision stage where possible.
- C3. Where side and rear boundary retaining walls intersect, ensure that the maximum height difference between the lowest bottom of wall and highest top of wall is 2.4m.
- C4. Council may consider variations to the controls within this DCP on Coordinated Development sites where applicants can demonstrate compliance with the objectives of the controls.

Lots with cross slopes

- C5. The subdivision layout must incorporate wider lots on the steeper sections of the site.
- C6. Narrower lots may be considered where it is proposed to subdivide the land as integrated development.
- C7. Boundary cut or fill and retaining walls are to be constructed at subdivision stage no greater than 900mm, unless otherwise stated.
- C8. Boundary retaining walls which extend beyond the front wall of the building must not be higher than 600mm (Pemulwuy South).
- C9. Preliminary finished ground levels are to be constructed at subdivision stage.

Lots with front to back slopes - Pemulwuy south

- C10. Rear boundary cut or fill and retaining walls of maximum 1.5m in height are to be constructed at subdivision stage of the development to reduce front to back lot grades.
- C11. No further rear boundary retaining walls are permitted.
- C12. Preliminary building pad levels shall be constructed at subdivision stage which provide for a minimum floor level split of 1m or as appropriate to facilitate split level house designs. See Section 3.3.2 - Elevated Sites (Steep Land) in Pemulwuy for requirements for cut and fill within building envelopes on front-to-back slopes.

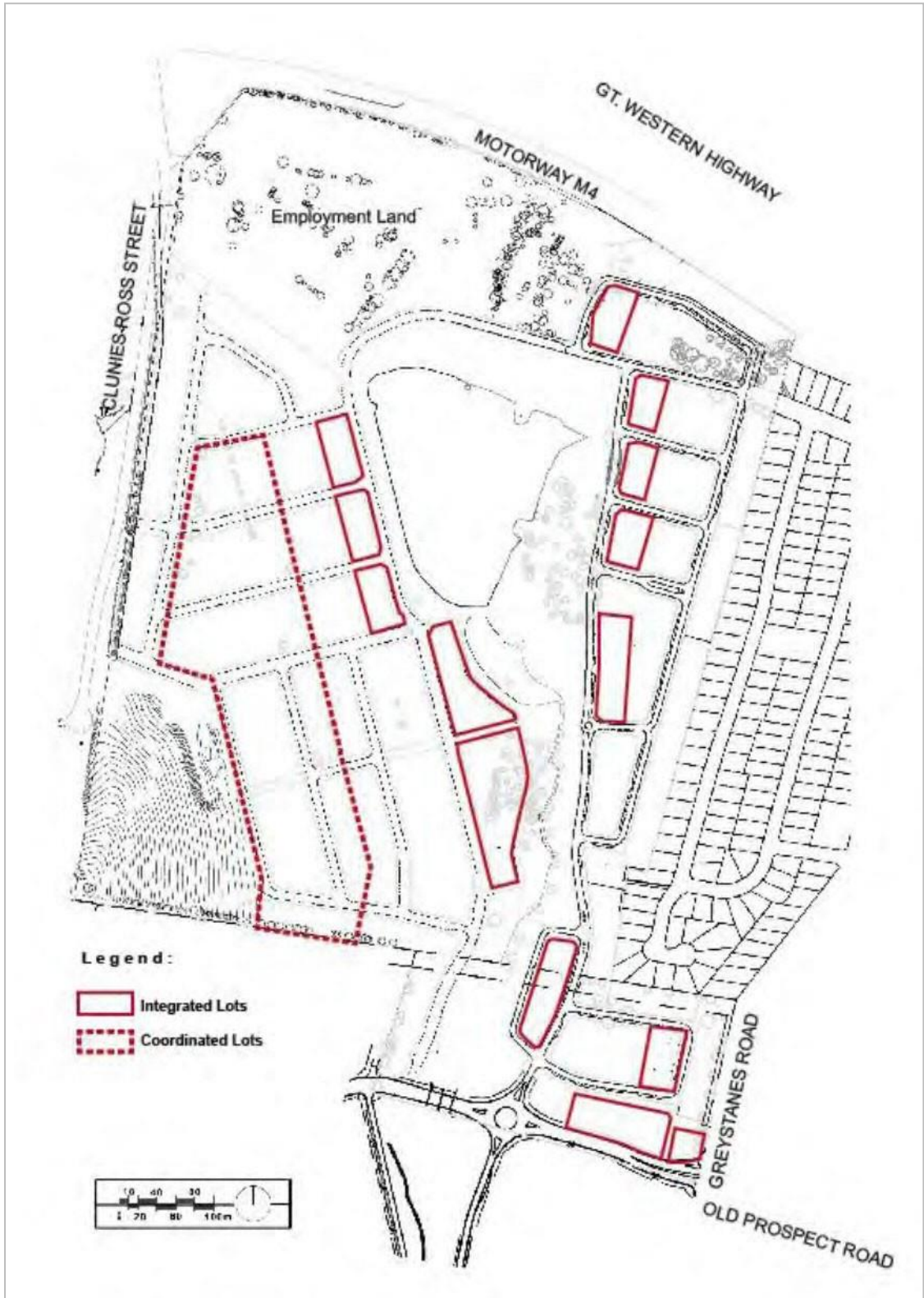

Figure 21: Integrated and coordinated sites in Pemulwuy North



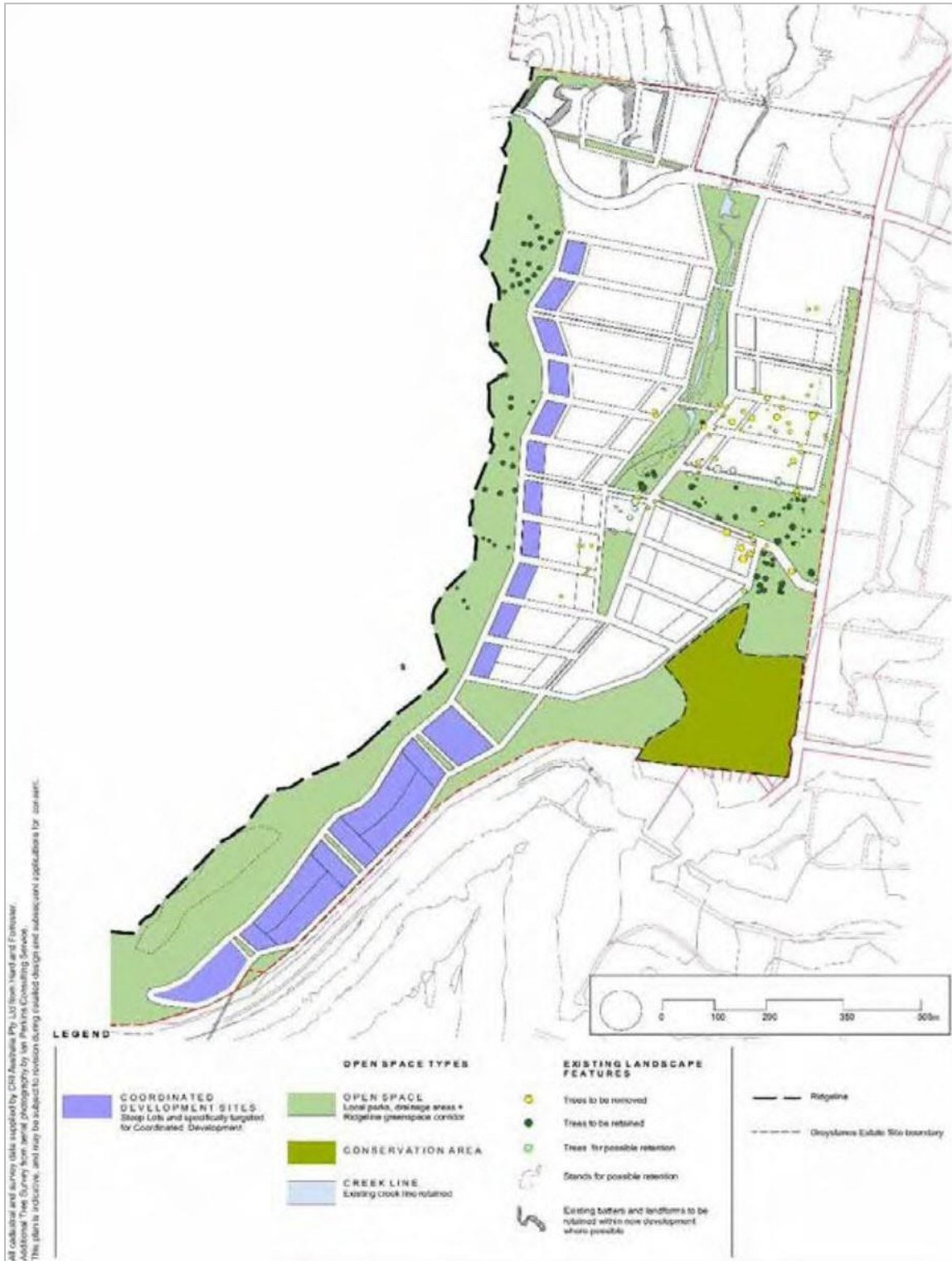

Figure 22: coordinated sides identified for Pemulwuy South

### **3.3 Building and Siting Requirements for Residential Development**

#### **3.3.1 Architectural Character**

##### **Objectives**

- O1. Interpret the subdivision pattern through building types.
- O2. Minimise cut and fill and not impede natural groundwater flow.
- O3. Reinforce the public domain, create attractive streetscapes with strongly defined parks and open spaces.
- O4. Provide a high level of amenity for occupants.
- O5. Maximise casual surveillance of dwellings from the street and of the street from the dwellings, to promote safer streets.
- O6. Develop building types that minimise potential salinity problems.
- O7. Provide for a variety of housing types and mix.
- O8. Adopt a contemporary design form.
- O9. Be responsive to the local climate, environment and lifestyle of western Sydney.
- O10. Improve the outlook and surveillance of streets and open spaces.
- O11. Develop a diverse range of housing styles of high quality, ranging from single lots to townhouses, integrated housing developments and apartments.
- O12. Provide for a variety of occupants and ages, and provide a more sustainable life cycle model than conventional monocultural housing development.

##### **Controls**

- C1. Provide a variety of building types and housing types throughout Pemulwuy in accordance with Figure 23 and Figure 24.
- C2. Accommodate a range of innovative dwelling types including single dwellings, home offices and home/work spaces.
- C3. Design, model and articulate dwellings with a consistent relationship to the street and to each other.
- C4. Design with a simplicity of building elements that create a contemporary façade. Avoid historical reproduction styles and/or mixtures of styles such as Federation, Edwardian, Colonial, Victorian and Georgian.
- C5. Modulate side boundary setbacks and incorporate courtyards, atria, toplights and the like to maximise solar access to dwellings.
- C6. Prefer elevated finished floor levels and entries, balconies and street elevations to improve outlook and surveillance of streets and open spaces.
- C7. Design corner dwellings to reinforce their prominent location and address both primary and secondary street frontages.

- C8. Ensure all dwelling entries are clearly visible from the street by day and night.
- C9. Ensure a maximum 500mm cut and 500mm fill for allotments unless otherwise stated elsewhere.

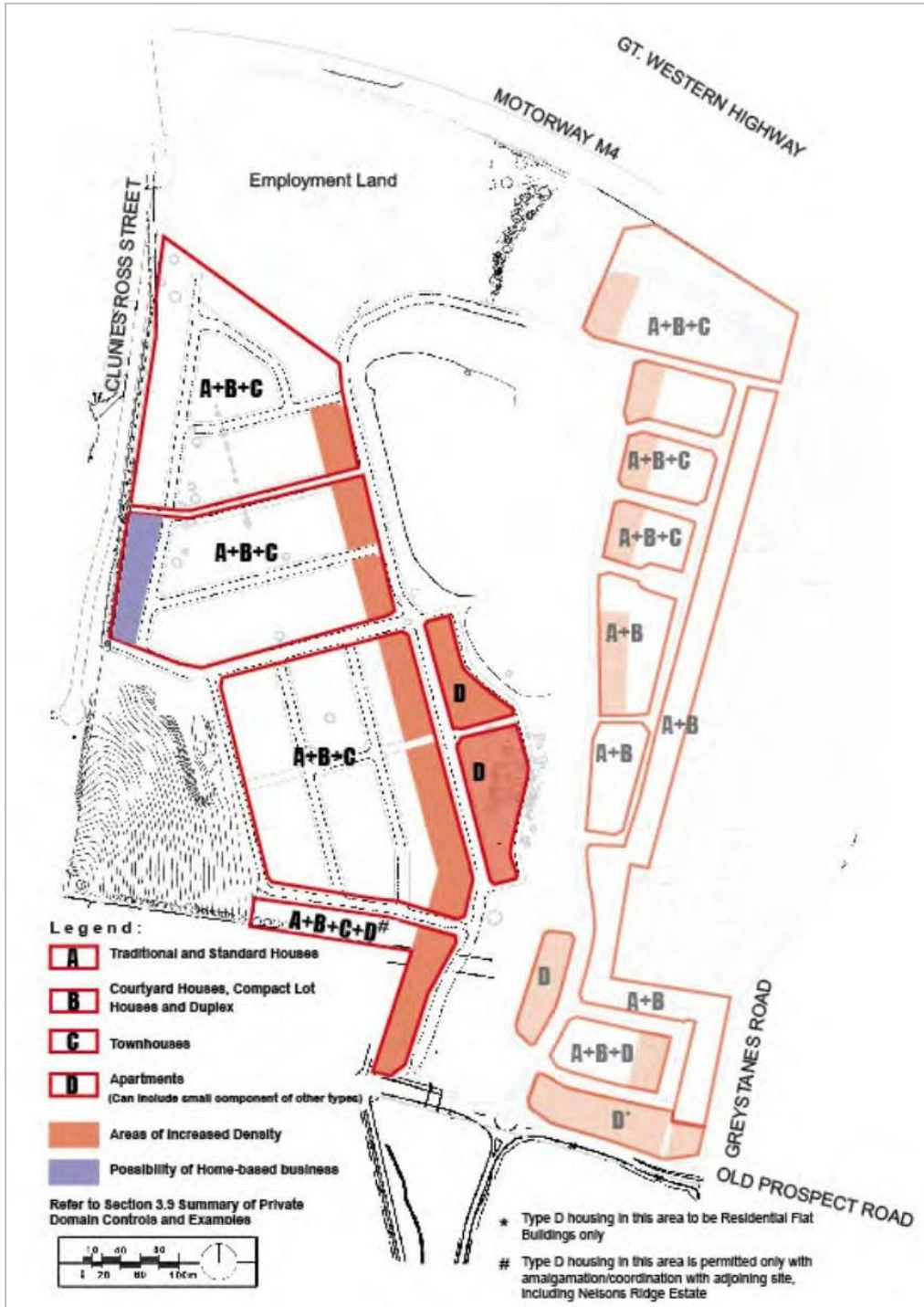

Figure 23: Housing types for Pemulwuy North



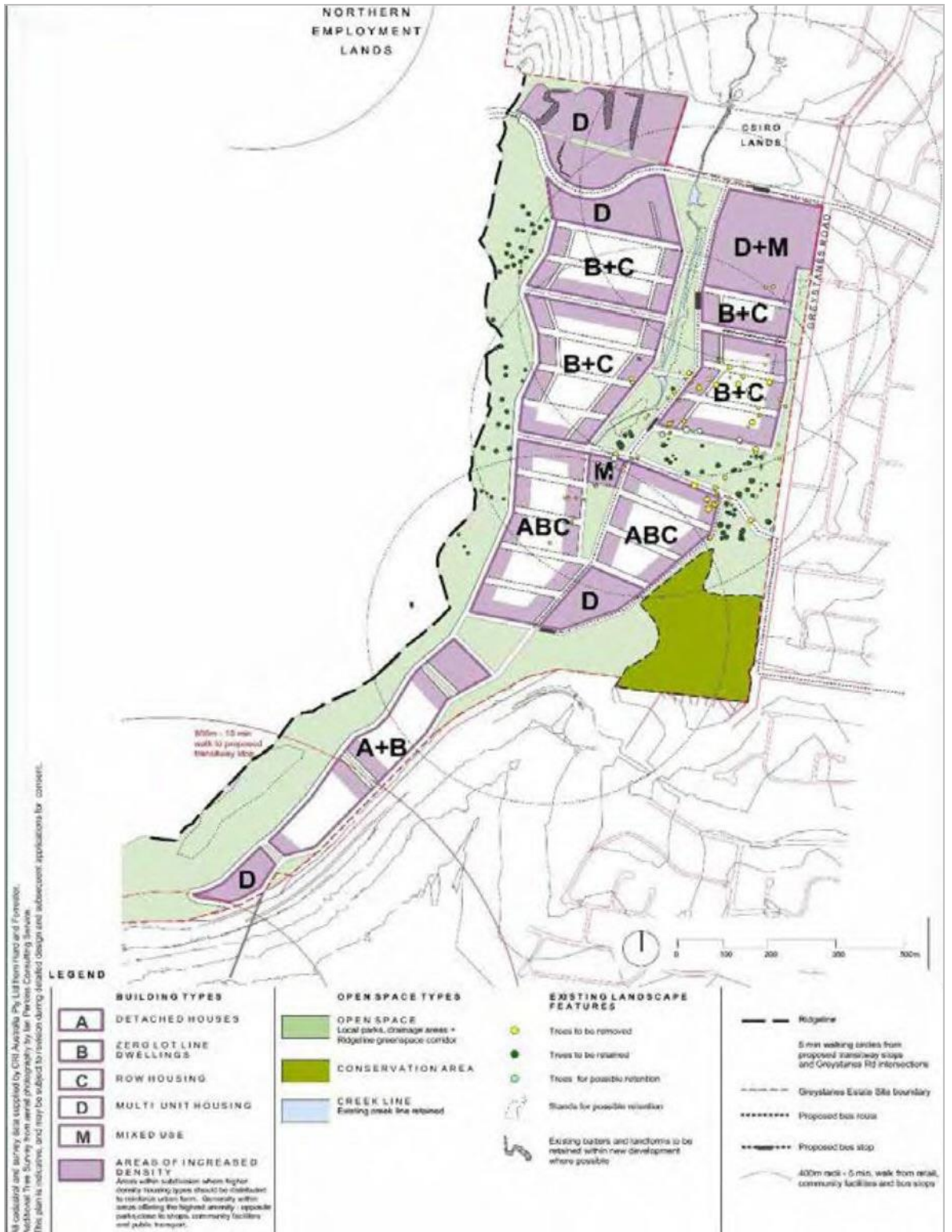

Figure 24: Housing types for Pemulwuy South



### 3.3.2 Elevated Sites (Steep Land)

Refer to Figures 25 and 26.

#### Objectives

- O1. Ensure that the built form responds to the topographical constraints, particularly the slope and orientation of each allotment.
- O2. Ensure that new development provides appropriate residential amenity, particularly with respect to visual privacy, and the relationship between dwellings.
- O3. Ensure that new development provides appropriate residential amenity, particularly with respect to solar gain to each allotment and the relationship between dwellings.
- O4. Ensure dwelling designs allow acceptable driveway grades for vehicular access to garages.
- O5. Minimise the bulk and scale of dwellings on steep slopes when viewed individually and collectively within and external to the site.

#### Controls

- C1. The maximum height for a dwelling house (in metres) is detailed within *Cumberland Local Environmental Plan 2021*, as a written statement and associated maps.
- C2. Dwelling designs must respond to the topography of the land through split level designs, unless privacy to adjacent properties can be maintained through alternative good design.
- C3. Elevated entries should be no more than 1m above the natural ground level at a point 3m set back from the front boundary.
- C4. The garage level is to be no greater than 500mm above or below natural ground level to help reduce driveway gradients.
- C5. Ensure dwelling designs allow driveway grades for vehicular access to garages that comply with AS 2890.1.
- C6. Retaining walls along on-street boundaries must be constructed of materials complementary to the home.
- C7. Retaining walls must comply with the *Building Code of Australia* (BCA).
- C8. No cut or fill is to be placed in easements to drain storm water.
- C9. Retaining walls constructed alongside boundaries and protruding forward of the adjacent front building line must be tapered to meet the profile of the finished ground level.
- C10. Where side and rear boundary retaining walls intersect, ensure that the maximum height difference between the lowest bottom of wall and highest top of wall is 2.4m (Pemulwuy North).
- C11. Brick walls are to be of salt proof construction. Dwelling design should consider: -
  - existing ground levels;

- proposed cut and fill, and finished floor (FFL) and existing ground levels as indicated on the proposed site plan; and
- existing sewer and drainage easements for stormwater and overland flows, and the impact any proposed retaining walls will have. Easements cannot be obstructed or built over.

C12. Development applications for elevated sites must include:

- top of wall (TOW) and bottom of wall (BOW) levels for retaining walls;
- full construction details of proposed walls including drainage, materials and finishes;
- connection into the stormwater system for behind-wall drainage lines and surface pits; and
- proposed finished ground levels (FGL).

#### Lots with cross slopes

C13. Where lots have side cross slopes which exceed 3 degrees (5%), designs must respond to the slope of the land through split house designs (see Figures 27 and 28).

C14. Maximum 500mm cut and 500mm fill within building envelope.

C15. Finished floor levels are to be no greater than 500mm above finished ground level. Where it can be demonstrated that a better design outcome can be achieved without compromising privacy, amenity and views into and out of the site, overshadowing and height controls, particularly relating to the bulk and scale of the dwelling, Council may consider relaxing the 500mm restriction up to a maximum of a 900mm total above the finished ground level.

C16. Garden retaining walls are not to exceed 700mm above finished ground level. Any remaining slope is to be graded out (Pemulwuy North).

C17. Dwelling heights and designs are to ensure reasonable visual privacy to the down-slope side of the dwelling, by incorporating privacy measures to minimise potential overlooking.

C18. Garages are to be located on the lower (eastern) side of side cross-sloped lots, and access is to be provided in accordance with *AS 2890.1 – Off Street Parking*.

C19. Maximum height of side fencing is 1.5m to reduce the overall wall/fence height (Pemulwuy South).

#### Lots with front to back slopes

C20. Where front to back slopes are steep, i.e. above approximately 5 degrees (9%), house designs must respond to the topography of the land through front-to-back full level split designs (Type 1 as shown in Figure 30).

C21. Where front to back slopes are moderate, i.e. approximately between 3 degrees and 5 degrees (4.5% and 9%), house designs are to respond to the topography of the land through split level designs (Type 2, refer to Figure 31).

C22. Maximum 700mm cut and 700mm fill for lots requiring a full-level split type 1 house design on lots with a front to back slope, to be contained within the building envelope.

C23. Finished floor levels are to be no greater than 500mm above finished ground level. Where it can be demonstrated that a better design outcome can be achieved without compromising privacy, amenity and views into and out of the site, particularly relating to

the bulk and scale of the dwelling, the Council may consider relaxing the 500mm restriction up to a maximum of a further 400mm (i.e. no more than 900mm total above the finished ground level).

- C24. Dwelling designs are to ensure reasonable visual privacy to the down-slope side of the dwelling, by incorporating privacy measures to minimise potential overlooking. See Section 3.3.9.
- C25. Where rear boundary retaining walls constructed at subdivision exceed 1.2m in height (to a 0.5m maximum), the maximum height of any boundary fence shall be 1.5m.
- C26. No further rear boundary retaining walls are permitted.
- C27. Garden retaining walls are not to exceed 700mm above finished ground level. Any remaining slope is to be graded out.
- C28. Driveway grades are to be in accordance with AS 2890.1.

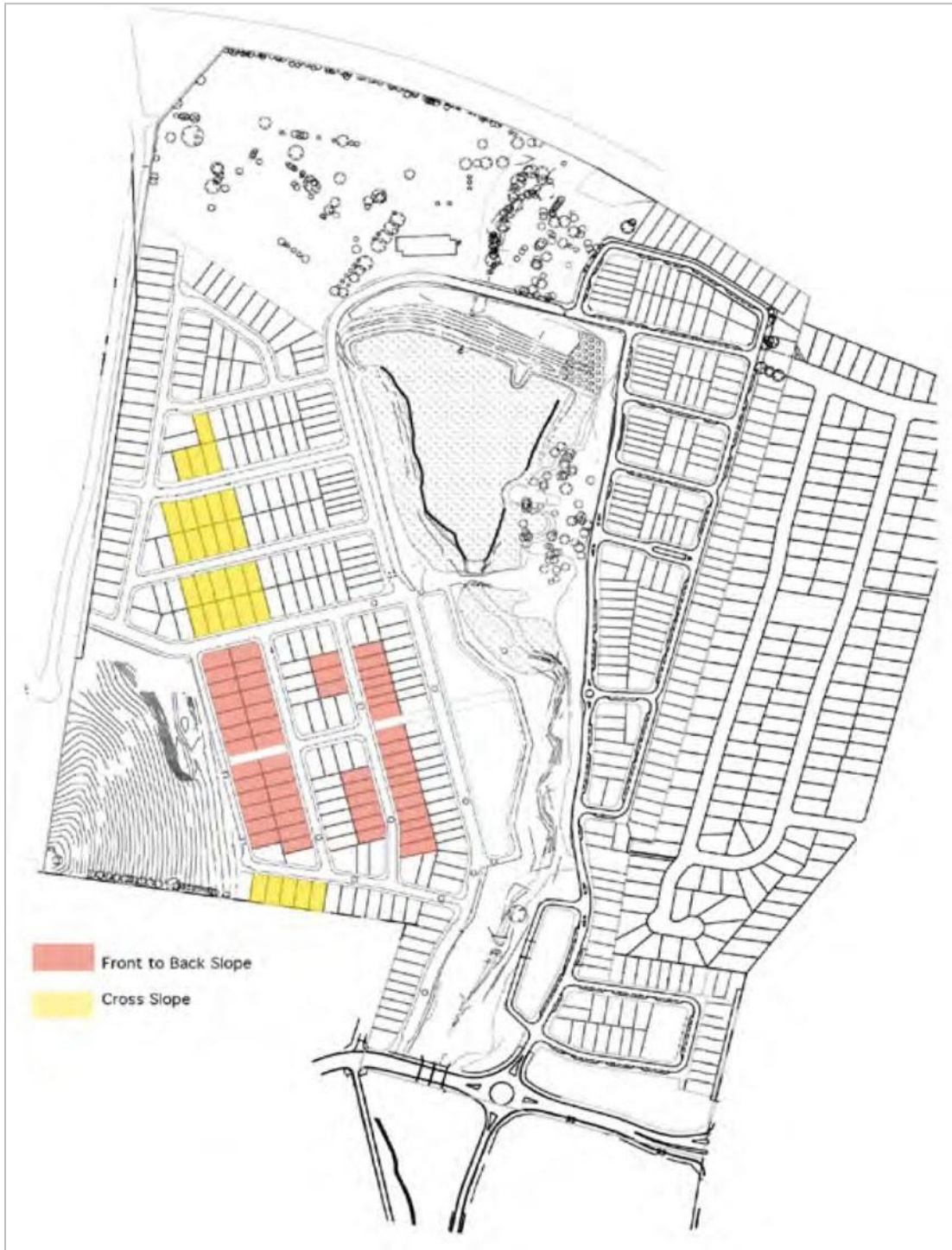

Figure 25: Steep land - Pemulwuy North

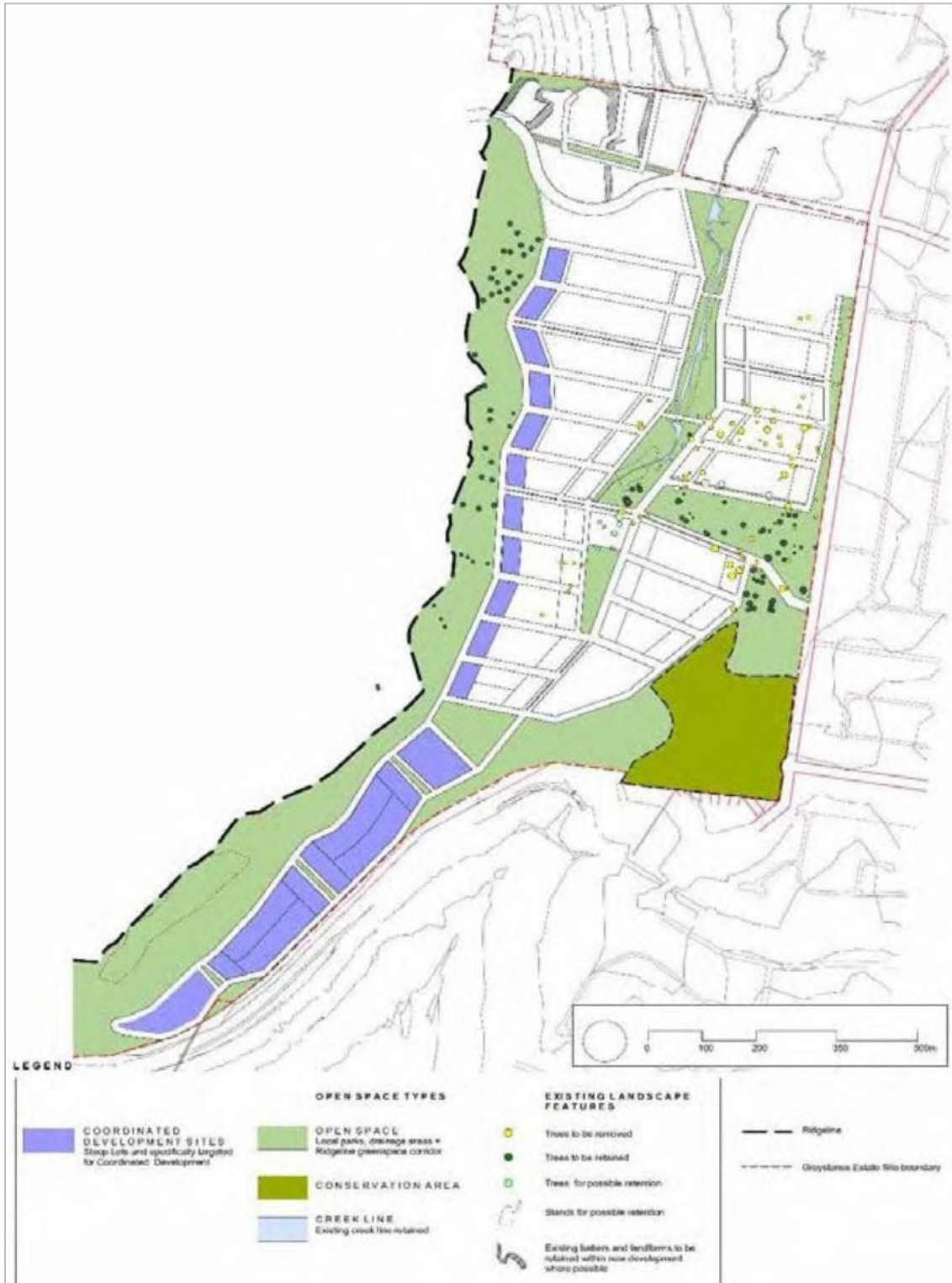

Figure 26: Steep Land - Pemulwuy South





Figure 27: Split level house designs for cross slopes

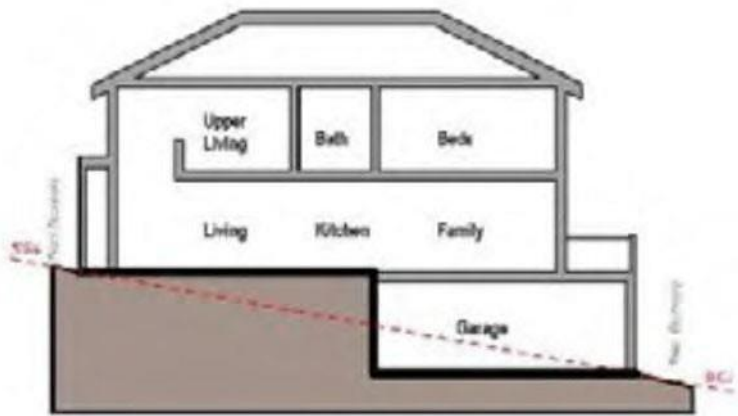

Figure 28: Section-cross slope lot

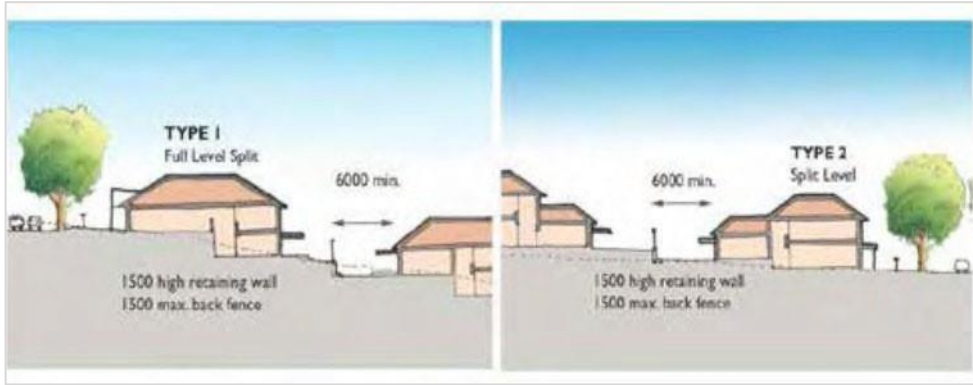

Figure 29: Front to back slope split level house design

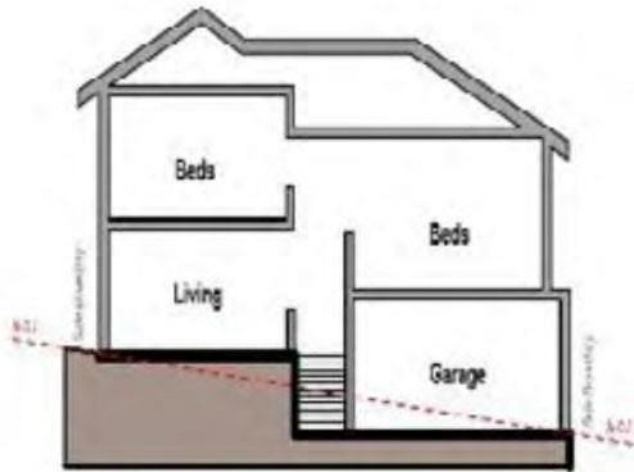

Figure 30: Type 1 Section through front to back slope lot



Figure 31: Type 2 Section front to back slope lot

### 3.3.3 Building to a Side Boundary

#### **Objectives**

- O1. Protect the residential amenity of immediately adjoining properties.
- O2. Provide efficient access along easements for the purpose of maintenance of the wall built to the boundary.
- O3. Protect adjoining properties from soil instability or damp arising from adjacent properties.
- O4. Design footings of the building built to the boundary to support and protect the building from damage in the event that disturbance or settlement occurs within the zone of influence.
- O5. Avoid significant adverse impacts upon stormwater behaviour along maintenance easements.
- O6. Avoid significant adverse impacts on stormwater drainage pipes along maintenance easements.

#### **Controls**

##### Boundary walls

- C1. For allotments with single street access (including corner allotments), only the ground floor wall of a 2 storey building may be built on the boundary, and for a maximum length of 10m.

Set first floor walls and balconies in 1m from the property boundary (see Figure 32).

- C2. For allotments with dual access (garage entry to the rear or double fronted lots) 2 storey walls may be built to the boundary where the building envelope permits.

*Note: A corner allotment is classified as a single access allotment in this instance.*

- C3. On sloping land, ensure that the wall built to the boundary is located on the lower side of the lot.

- C4. Ensure that the wall built on the boundary is finished to match the front of the house.

- C5. Generally locate the garage against the side property boundary.

- C6. Design the footings and finish of the wall built to the boundary to allow for the maximum cut/fill on the adjoining allotment along the boundary. Ensure that the footings extend below their zone of influence, where they will affect the laying of services within excavation of the adjacent maintenance easement. If the adjoining dwelling has not yet completed construction, see Figure 34 - Detail A. If the adjacent house has completed construction, refer to Figure 35 - Detail B, showing the need for a retaining wall.

*Note: Both figures assume a cut of 500mm, which may vary by up to a further 400mm in each instance (max. side boundary wall cut/fill is 900mm). Note: There may be further variations where slope is extreme, but these are subject to privacy, neighbour amenity, overshadowing and height controls.*



- C7. All piers along the drainage easement boundary to have a minimum depth equal to the level of the invert of any potential or constructed stormwater pipe or culvert.
- C8. Ensure that the drop-edge beam on the adjoining property is treated with a masonry surface treatment suitable to exposure to view.

Maintenance easements

- C9. Where a maintenance easement is created on a property adjacent to a wall built to the boundary, ensure that any retaining wall constructed within the easement. In particular, ensure a maintenance easement of minimum width 900mm.
- C10. The following should be considered for maintenance easements:
  - a maximum cut into the easement of 300mm;
  - any retaining wall within the easement has a maximum height of 300mm plus 300mm of post below ground, consistent with Figure 35 below;
  - a minimum post width of 200mm;
  - a minimum distance between the retaining wall and any built structure on the property of 600mm, to allow maintenance access;
  - in the event of fill in the maintenance easement being placed against a wall built to the boundary on the adjacent property, ensure that the fill does not interrupt the effective discharge of moisture from weep-holes in that wall;
  - landscape planters placed in the maintenance easement should not interfere with access to the wall, and to stormwater flow where appropriate.
  - a drainage pipe between the retaining wall and property line to avoid significant adverse impacts upon stormwater behaviour; and
  - a maximum timber paling fence height of 1.8m, comprising a 300mm retaining wall and 1.5m timber fence.

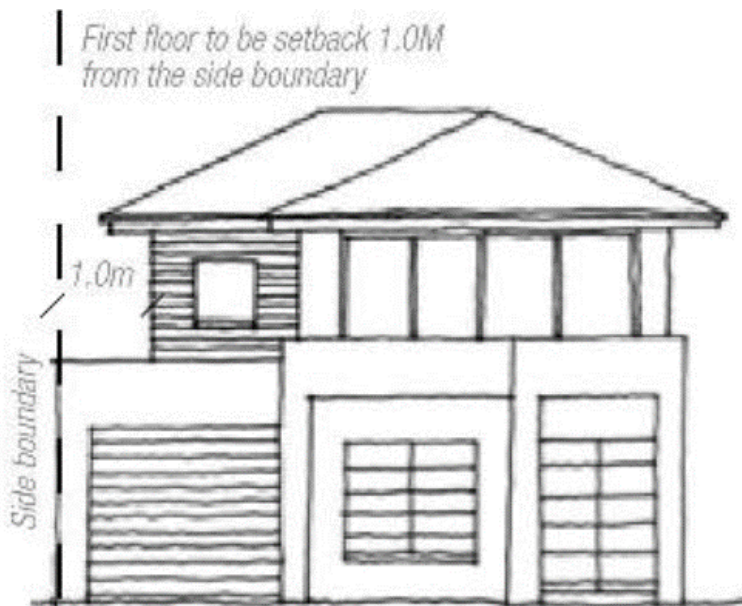

Figure 32: Side setback

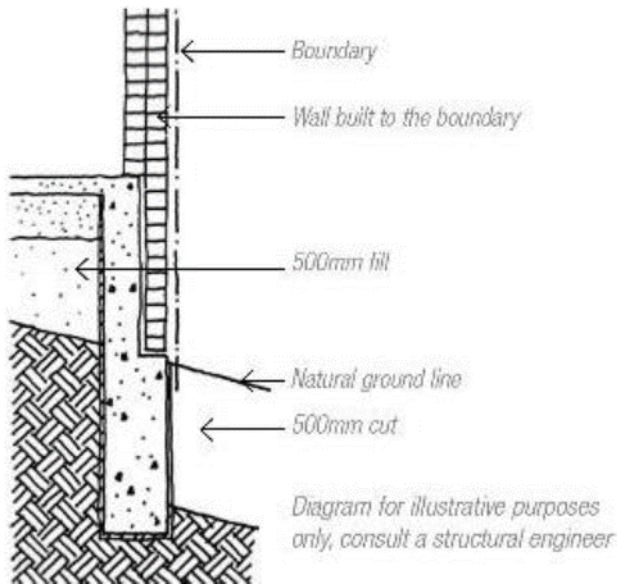

Figure 33: Drop edge beam detail A

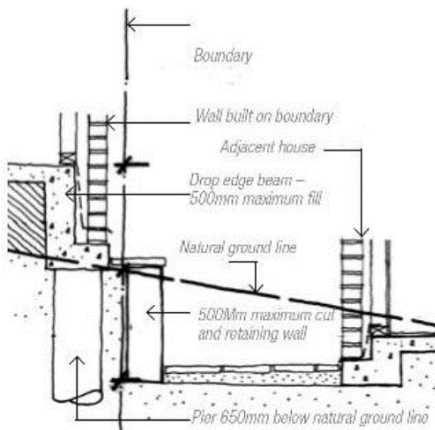

Figure 34: Drop edge beam detail B

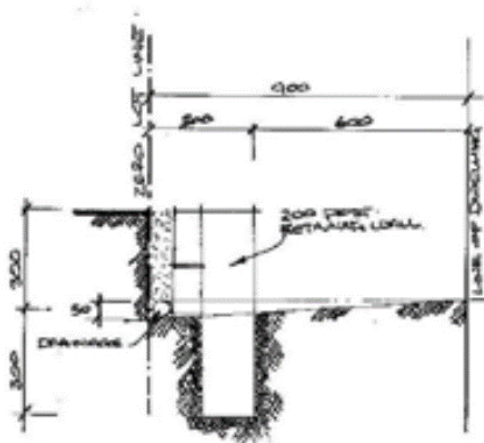

Figure 35: Retaining walls within maintenance easement

### 3.3.4 Building Articulation and Street Address

#### Objectives

- O1. Develop a relationship between buildings and the street through entries, porches, verandahs, balconies, bay windows and the like.
- O2. Ensure entries to all houses are clearly visible from the street.
- O3. Promote the safety and security of streets and parks through entry points, windows, doors and balconies in the front façade.
- O4. Provide elements and features on those parts of the dwelling seen from the street to articulate the building as well as contribute to attractive and safer streets and parks.

#### Controls

- C1. Develop the architectural character of buildings with appropriate solar protection elements, expressed door and window openings, and the like.
- C2. Design buildings which incorporate articulation to the built form and do not rely on “add on” structures to break up the façade.
- C3. Accommodate a range of roof forms in order to provide variety and reduce the bulk and scale of the streetscape.
- C4. Design dwellings to incorporate variety in materials, colours and finishes to external elevations.
- C5. A minimum 2m x 2m build free zone in the front setback area is required for a mandatory native tree in the front garden.
- C6. Articulation elements are required in the design of your home. These elements may protrude 1.5m into the 3m setback, without encroaching on the 2m x 2m garden bed.
- C7. Articulation elements must be lightweight in design and of an open nature. For example: pergolas, not solid roofs are permitted over balconies in the front setback area. Balustrades to balconies should be open and not solid.
- C8. Where roofs are proposed to first floor balconies at the street elevation they must be set back a minimum 3m from the front boundary.
- C9. On a corner allotment, articulation elements are also required to the secondary street. They may protrude up to 500mm into the side setback.
- C10. For side elevations/facades on corner lots; the maximum run of un-broken wall length is 12m. A step of 480mm in the wall must otherwise be designed (Pemulwuy North).
- C11. Consider active street frontage, defined as one or a combination of:
  - clearly defined and accentuated building entrances;
  - building articulation through modulation in the façade, incorporating elements such as blade walls, chimneys, entries, balconies, verandahs, porches, loggias, bay windows, screens, awnings and feature walls with a combination of materials and colours;

- building designs which provide passive/active surveillance through providing living areas to the street frontage;
  - shop front café or restaurant; and
  - commercial and residential lobbies if accompanied by an entrance.
- C12. Ensure garages and carports must not dominate the street frontage. Garages are to be a recessive element and shall be located a minimum distance of 1m behind the front wall of the dwelling (excluding any projecting elements).
- C13. Ensure carports and garages facing a public street or accessway are no more than 6m or 50% of the frontage width, whichever is the lesser (Pemulwuy North).
- C14. Individual entries are to be provided to 50% of ground floor dwellings within residential flat buildings.
- C15. Address and activate all streets with street frontages that promote surveillance. The design and layout of any car courts should improve safety through short distances with good sight lines and the use of a mews dwelling above the garages in some places to increase potential for passive surveillance.
- C16. Provide a path leading from the street to the front door that is physically separated from the driveway.
- C17. Ensure access between a dwelling and street frontage is unobscured and direct.
- C18. Finished floor levels of the porch/verandah for front to back slope lots in Pemulwuy North should be at the same level to the footpath. When the finished floor level of the porch/verandah is lower than the footpath, it must not exceed 600mm from the footpath RL.
- C19. Elevated front entries should be no more than 1m above the natural ground level.
- C20. Open types of security screening maybe used on windows facing the street. Block out security shutters are not permissible on front elevations.

### 3.3.5 Setbacks

*Note: Further to the general Setback controls below, certain specific setback requirements apply just to the Pemulwuy North or South sub-precincts. See Sections 3.4 (North) or Section 3.5 (South), and Section 3.4.3 Development Adjacent to Employment Lands (in particular the former CSIRO Employment Land).*

#### **Objectives**

- O1. Provide setbacks to reinforce the vegetated character of the public domain with front gardens.
- O2. Establish continuous gardens in deep soil planting in the centre of blocks to increase the amenity of private blocks.
- O3. Ensure no loss of amenity by neighbours.

#### **Controls**

*The setback controls for Pemulwuy North and South vary slightly, and are therefore addressed under their specific precincts below (Sections 3.4 and 3.5), and summarised here. In all instances of building to a side boundary, the length and height of walls on the boundary ensure no loss of amenity by neighbours. Sections 3.3.5 to 3.3.7 also aim to control setbacks.*

Table 1a: Setbacks

	Pemulwuy North	Pemulwuy South
Front of building	3m-4.5m (depending on vicinity of riparian public open space - see Figure 5.4)	3m
Front garage	5.5m	5.5m
Front porch / verandah	½ into front setback, but not unroofed	
Rear set back	1 storey = 6m 2 storey = 8m If rear garage (as below) = 3m from garage to dwelling	A. North-South lots: Lot depth max. 35m = 6m Lot depth >35m = 8m  B. East-West lots: little streets = 3m from garage to dwelling other streets = 4.5m
Rear garage	0m, (via a "shared vehicular access")	0m, if via a "little street" or "shared vehicular access" (not a public street)
Side setback	Type A detached dwelling = 0.9m to both Type B dual occupancy/courtyard = 0.9 + 0m  Type C townhouse/rowhouse = 0m to both  Type D Apartments = 3m	Type A detached dwelling + courtyard = 0.9m to both Type B dual occupancy only = 0.9 + 0m Type C low density townhouse/rowhouse = 0m to both Type D Apartments + higher density townhouse = 3m
Secondary street frontage	1.5m+	4m (from Part B Residential Controls)

### 3.3.6 Soar Access and Sun Shading

#### Objectives

- O1. Achieve a northerly orientation and midwinter solar access to main indoor living spaces and primary private open spaces.
- O2. Provide sun protection on glazing with appropriate orientation.

#### Controls

- C1. Windows of north facing/orientated habitable rooms of dwellings are to receive a minimum of 4 hours of direct sunlight between 8:00am and 4:00pm on 22 June.
- C2. New development must not result in windows to north facing living areas of neighbouring dwellings receiving less than 4 hours direct sunlight between 8:00am and 4:00pm 22 June.

- C3. Private open space is to achieve at least 3 hours of direct sunlight between 9:00am and 3:00pm in on 22 June for 50% of the required private open space.

*Note: Relaxation of these controls may be permissible on Coordinated Development and Integrated Housing Sites where a development application for subdivision demonstrates that solar access has been maximised through integration of built form controls.*

- C4. Where relaxation of these controls has occurred, design initiatives that maximise natural light into dwellings are to be incorporated. For example, through wider frontages, courtyard housing, and material selection.
- C5. On north facing facades, minimise summer solar access and maximise winter solar access. To achieve this, consider measures such as external horizontal shading, eaves, awnings, balconies, pergolas with appropriate planting and the like.
- C6. On east and west facing facades, minimise summer solar access and maximise winter solar access. To achieve this, consider measures such as external adjustable vertical shading, sliding screens and adjustable louvers and the like.
- C7. The design of dwellings shall generally be consistent with the Lot Orientation Principles in Figure 36 and Solar Orientation Principles in Figure 37 in order to achieve optimum solar access.

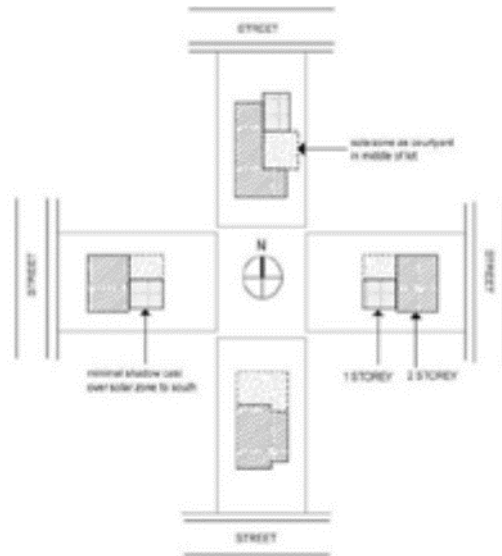

Figure 36: Solar access by lot orientation

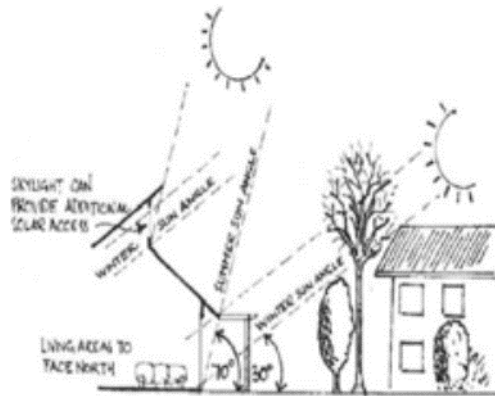

Figure 37: Solar access



Figure 38: Solar access to private open space

### 3.3.7 External Private Open Space

#### Objectives

- O1. Provide useable private open space related to the needs of residents for leisure, recreation, outdoor entertaining and service functions.
- O2. Soften the appearance and integrate the homes and fencing.
- O3. Provide screening for privacy, and shade during the summer months.
- O4. Complement street tree and parkland planting.
- O5. Ensure continuation of green corridors from conservation areas through the riparian corridor and up onto Prospect Hill.
- O6. Protect and enhance locally indigenous biodiversity.
- O7. Reduce the impact of soil loss on adjoining properties.



## Controls

- C1. Provide useable private open space, directly accessible from living and/or dining areas to each dwelling.
- Type A, B and C dwellings are required to provide an area equivalent to 20% for Pemulwuy South and 30% for Pemulwuy North of the total site area as a pervious (soft) surface.
- C2. Type D dwellings (and Type M in the case of Pemulwuy South) are required to provide an area equivalent to 20% of the total site area as external private open space, at ground level or in the form of a balcony.
- C3. Private open space is to achieve at least 3 hours of direct sunlight between 9:00am and 3:00pm on 22 June for 50% of the required private open space. Refer to Figure 38.

### Private open space elements

- C4. All private open space (excluding balconies) is to have a minimum dimension of 3m which is to be accessible from living or dining areas, and be suitable for outdoor living.
- C5. Balconies are to have a minimum dimension of 2.4m where they are accessible from living or dining areas. In such cases, they can be used in the private open space calculation. This dimension may be reduced to 1.8m where functionality can be demonstrated.
- C6. Balconies should be located to provide active street frontages.
- C7. All existing trees shall be retained unless it can be demonstrated that this cannot be incorporated into the design.
- C8. Private open space elements accessible from other habitable rooms and secondary living spaces are to have a minimum dimension of 1.2m. (Pemulwuy North).

### Hard and soft landscaped area

- C9. A minimum of 20% for Pemulwuy South and 30% for Pemulwuy North of the total site area shall remain as a pervious (soft) surface, unless otherwise noted on Figures 39 and 40.

Where impervious areas exceed 80% for Pemulwuy South and 70% for Pemulwuy North of the total site area, Council will require an on-site detention system.

*Note: These figures may be affected by the future provision of community detention basins. Changes are at the discretion of Council's engineering staff.*

- C10. No more than 45% of the front setback area shall be paved or sealed (inclusive of driveway). Where a double garage is proposed, this may increase to no more than 50% of the front setback.
- C11. Front and rear setback areas are to be landscaped in accordance with the setback requirements provided in Section 3.3.3 (Setbacks) and Figures 40 and 41. The area to be landscaped may incorporate garden beds, soft landscaping, paved areas, paths, swimming pools and driveways.
- C12. The planting proposal for the front setback should utilise plants with varying heights with the overall objective being to reduce the impact of the development on the streetscape.



Planting should comprise of all 3 canopy levels, i.e. upper and lower canopies, and groundcovers.

- C13. A native tree is required to the front and rear of each proposed dwelling, with a mature height at least equivalent to the height of the proposed dwelling. Minimum pot size 75 Litres.

*Note: in the case of a dual occupancy this means 1 tree to the front and rear of each unit.*

- C14. The entire front yard/setback of all new dwellings in Pemulwuy is to be planted out with only native plant species, at least 20% of which are to be locally indigenous to the Cumberland LGA (see Council's Native Tree List).

*Note: The use of indigenous species or low water use species within a portion of the open space is required for certification under the new BASIX regulation from 1 July 2004. Visit [www.basix.nsw.gov.au](http://www.basix.nsw.gov.au) for more information.*

- C15. Plant predominantly native landscaping to the front and rear of each allotment to enhance the natural environment. The limited use of exotic species is permitted in the rear yard only.

- C16. Planting in the front and rear setbacks should include additional plantings to provide both privacy and screening to adjoining residents as well as softening of retaining walls, and fencing.

- C17. Type D and M dwellings are required to distribute this landscaped area as a combination of private and communal open space to provide privacy between dwellings, useable outdoor spaces and gardens.

- C18. Provide a minimum 500mm setback (in the form of a landscape strip/garden bed) between the driveway and side boundary. It is required that this area be planted with suitable native plant species.

*Note: take into consideration the possible accommodation of a retaining wall where cut and/or fill has occurred on sloping lots. Where there is a zero lot alignment, the 500mm setback may include both the landscape strip/garden bed and retaining wall where bed width is maximised to a minimum 270mm for planting.*

- C19. The driveway and pedestrian access path shall be separated by a landscape strip/garden bed.

- C20. When constructing brick or masonry garden and retaining walls, water features, paving or other hardscape elements, select brick & mortar or masonry that is suitable for saline soils. For example, appropriate footings and linings should contain concrete Type C and 32MPa.

#### Landscape documentation

Accompany all applications with a fully documented landscape concept plan consistent with that required in Part G, prepared by a qualified Landscape Architect. The Council approved landscape plan is the plan to be used by the company, or owner, constructing the landscape works. As such it is important the plan provides enough details to enable construction. Likewise, an Implementation Report and Maintenance Report are required. See Part B (External Private Open Space) of this DCP for all built form development applications within Pemulwuy.

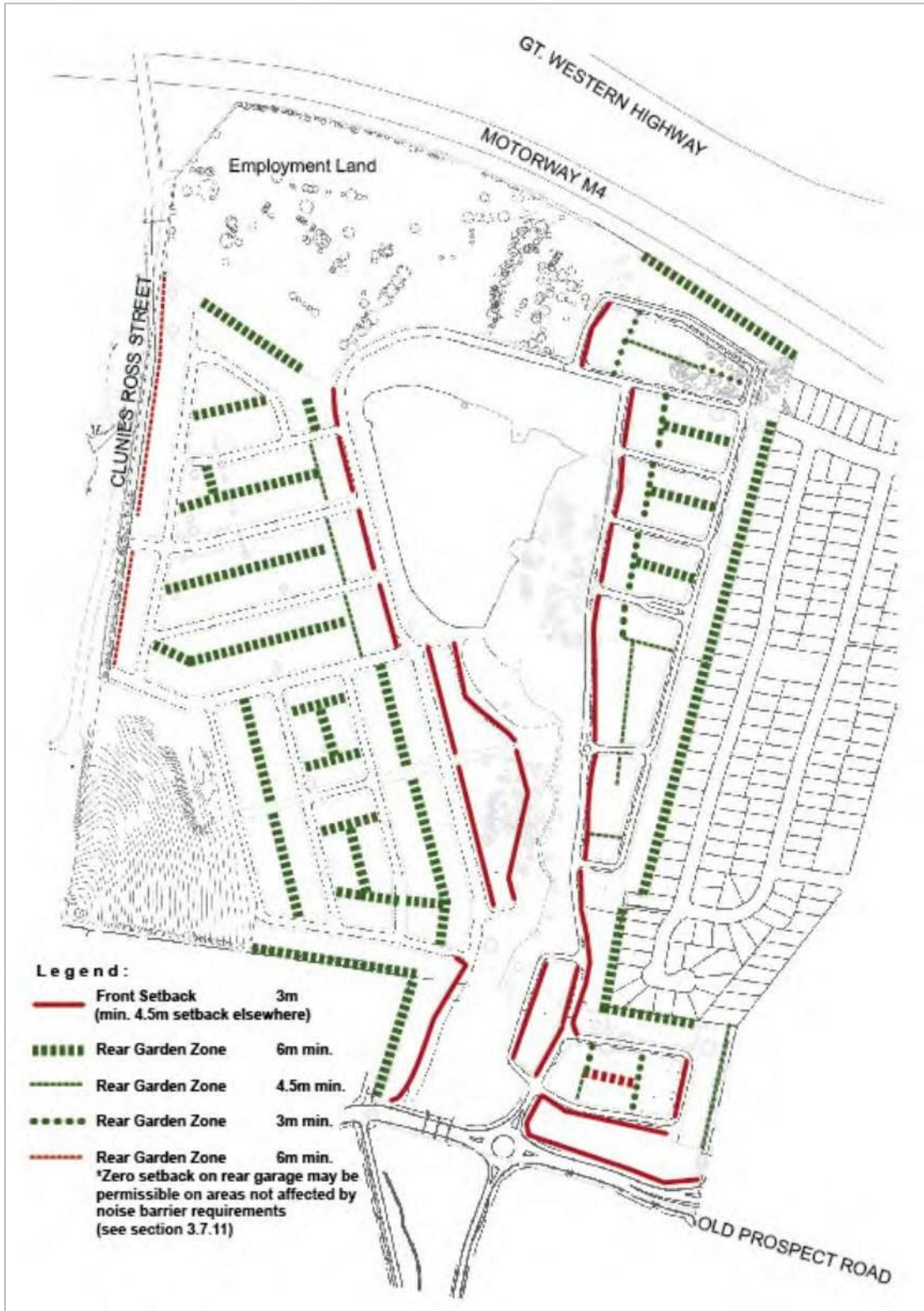

Figure 39: Private open space - Pemulwuy North



Figure 40: Private Open Space - Pemulwuy South

### 3.3.8 Plant Selection

#### Objectives

- O1. Ensure a high standard of environmental quality of individual developments.
- O2. Produce the highest landscape value for the local character.
- O3. Provide a mix of native/endemic vegetation to promote low water use and encourage native wildlife into the area.
- O4. Protect visual privacy through plant selection.
- O5. Regulate micro-climate through plant selection.
- O6. Manage the land to minimise groundwater salinity.
- O7. Mitigate any adverse effects of the proposed development on the species, populations or ecological communities.

#### Controls

- C1. The front setback area is to consist entirely of native plant species with at least 30% of the proposed species being local to the Cumberland City area. A list of native species suitable for Cumberland City Council area is provided on the following table.
- C2. A suitable native tree shall be provided to both the front and rear setback.
- C3. Screen planting should be provided along all side and rear boundaries to the private open space area (Pemulwuy North).
- C4. Exotic species are permitted in rear yards only.
- C5. Landscaping should provide a visual screen and contribute to summer shading and winter sun penetration.
- C6. Species of plants shall be chosen to minimise water use.
- C7. The selection of the type of plant should be based on:
  - the purpose of the plant. If planting on the northern side of the house, deciduous (loses its leaves) trees and plants should be considered to provide summer shade and allow winter sun to get through; and
  - the ultimate height and spread above and below ground of the plants in relation to adjacent buildings, services and other plants and the scale of the location.
- C8. Council requires the use of Buffalo turf species including 'Sir Walter' in the front yard and encourages its use in the rear yard within all residential lots. Specify in landscape plans that existing turf to the nature strip is replaced at completion of construction works with 'Sir Walter'.
- C9. Pemulwuy is affected by existing saline and sodic soils, as described in Section 3.9.6 of this Part of the DCP. Therefore, favour gardens which do not require a lot of watering, and avoid species that are sensitive to the above soil types.

*Note: A table of trees, shrubs and ground covers specific to Pemulwuy but can be found on Council's website under Pemulwuy. This list can be read in conjunction with a*



*broader list of native trees and shrubs suitable to the Cumberland City area, also found on Council's website.*

### 3.3.9 Privacy

#### **Objectives**

- O1. Ensure visual and acoustic privacy for residential development, both within a development and between a development and its neighbours.
- O2. Ensure an acoustic environment suitable for residential uses.
- O3. Ensure that the siting and design of development minimises the impacts of noise transmission between properties.

#### **Controls**

##### **Visual Privacy**

- C1. Dwellings are to maximise visual privacy through consideration of the layout of internal rooms and external living spaces, design of openings, screens, walls and choice of materials.
- C2. Protect privacy and encourage integrated outdoor living spaces by orienting primary openings in living areas to the street and/or rear gardens.
- C3. Upper storey windows (excluding stairwells), and balconies (within 6m of the rear boundary) facing a side or rear boundary must incorporate privacy measures.
- C4. Achieve privacy in the design of housing by providing the following separations to all openings (windows, doors or balconies) between rooms in multi-unit dwellings and between openings facing the rear boundary of single dwellings at ground level:
  - 6m between non-habitable rooms;
  - 9m between a habitable and non habitable room;
  - 9m between a habitable room and a balcony; and
  - 12m between habitable rooms.
- C5. Where possible, openings should be off set to reduce setbacks, and in addition, screening and other treatments may be considered in reducing separation distance whilst maintaining adequate visual privacy.
- C6. Minimise privacy conflicts through:
  - careful consideration of the layout of internal rooms and external livings spaces;
  - design of openings;
  - 1.5m minimum sill height;
  - fixed and obscure glass to 1.5m above first floor finished floor level with clear glass permitted above;
  - screens;
  - blade walls;
  - external fixed privacy screen; and
  - choice of materials.
- C7. Within apartments, townhouses and Mixed Use Development containing Residential, such as Aged Housing, Apartments integrated with Retail/Commercial or Community Facilities, and Residential Flat Buildings, windows are to be offset from windows in an

adjacent development to limit views. Alternatively, sill heights of 1.5m above finished floor level are to be provided.

- C8. Bathroom or ensuite windows fronting the street must incorporate privacy measures.
- C9. Elevated ground floor levels to the rear or side of the property, including the main built form, terraces, decks and balconies that exceed 500mm above natural ground level must incorporate privacy measures to minimise potential overlooking.
- C10. Landscape screening at the rear of terraces, decks and balconies may be acceptable in some situations.
- C11. Upper floor windows or balconies within 6m of the rear boundary must incorporate privacy measures.

Acoustic privacy

- C12. Dwellings are to maximise acoustic privacy through consideration of the layout of internal rooms and external living spaces, design of openings, screens, walls and choice of materials.
- C13. The design of buildings should minimise the opportunity for sound transition through the building structure and should protect noise sensitive areas such as bedrooms.

*Note: Additional documentation may be required to be submitted with a Development Application to demonstrate that the privacy of adjacent properties will not be compromised*

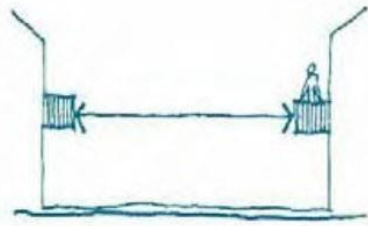

*unscreened balcony separation*

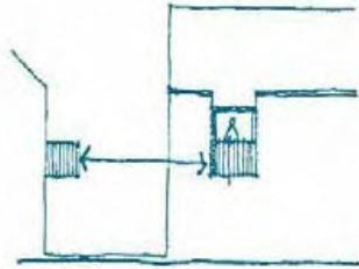

*careful location and screening of balconies can increase privacy and reduce their separation*

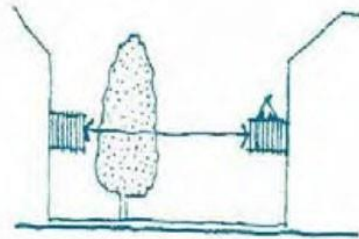

*existing vegetation may offer screening so separation can be reduced*

*Figure 41: Achieving acoustic and visual privacy*

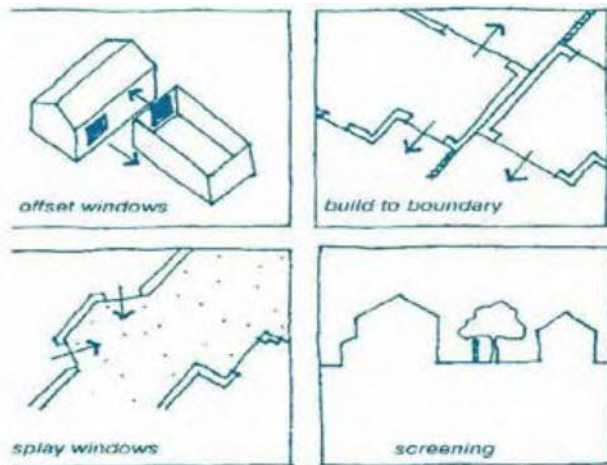

*Figure 42: Achieving acoustic and visual privacy*

### 3.3.10 Clunies Ross Street Residential Frontage

#### Objectives

- O1. Minimise the impact of noise from the existing employment sites to proposed residential areas.
- O2. Achieve external noise goals where feasible or reasonable.
- O3. Where this is considered impractical, to achieve internal noise criteria by appropriate façade treatment.

#### Controls

- C1. A noise barrier ranging from 4m to 4.5m in height is to be erected along the western site boundary between the employment lands and the Clunies Ross Street access road to control noise to the ground floor of future dwellings (refer to Figure 44).
- C2. Control sleep arousal to second storey bedrooms, additional attenuation measures are required. These should consist of, but are not limited to:
  - improved glazing to windows and the provision of air conditioning to allow windows to be kept closed during night time periods; and/or
  - locating bedrooms on the eastern side of the house away from the noise source, with bathrooms, study, media rooms and the like on the western side of the house.

*Note: The combination of attenuation measures to the built form is to be determined at Development Application stage based on the advice of an acoustic consultant.*
- C3. Ensure that noise from employment related uses in Pemulwuy does not exceed stated criteria in Section 3.10.6 entitled *Environmental Management – Noise and Vibration Management*, when measured at the residential receiver.
- C4. Ground floor bedrooms are to be setback a minimum of 10m from the acoustic barrier.
- C5. Second storey bedrooms are to be setback a minimum of 14m from the acoustic barrier.
- C6. A landscape buffer and mound of 3m in width consisting entirely of native species is to be provided in front of the acoustic barrier to ensure suitable aesthetic outcomes (refer to Figure 43 for landscape concept design) The landscaping design is to:
  - consisting of entirely native species;
  - screen the acoustic wall; and
  - minimise on-going maintenance requirements.



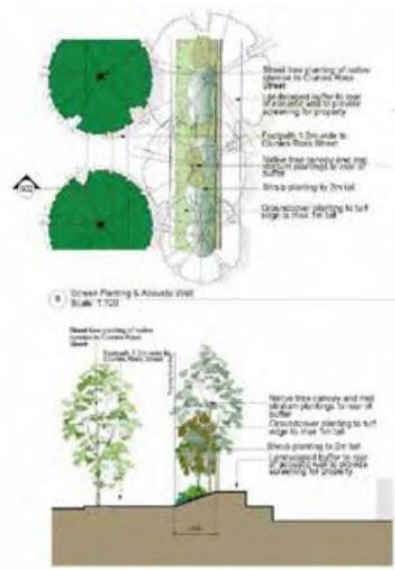

Figure 43: Extent of acoustic wall



Figure 44: Acoustic wall.

### 3.3.11 Roof Design

#### Objectives

- O1. Design roofs to contribute to the variety and diversity of homes in a street.
- O2. Design roofs to reflect a contemporary style.

#### Controls

- C1. Provide from these acceptable styles: hipped, gable, skillion, flat roofs with parapets and curved roofs.

- C2. Prefer that traditional roof forms, such as hipped and gable roofs, have a minimum pitch of 25 degrees (Pemulwuy South), or 22.5 degrees (Pemulwuy North).
- C3. Prefer that skillion roofs have a pitch between 10 and 20 degrees (Pemulwuy South), or above 5 degrees (Pemulwuy North).
- C4. Ensure that all roofs have a minimum of 450mm eaves or other shading devices such as awnings, louvres, pergolas or screens.

### 3.3.12 Materials and Colours

#### **Objectives**

- O1. Use building mass or bulk/reflective insulation in wall and ceiling systems to encourage an improved thermal performance.
- O2. Use building materials and building techniques that will minimise salinity problems.
- O3. Use external materials and colours that reflect the contemporary nature of Pemulwuy.

#### **Controls**

- C1. Ensure a predominantly masonry external finish. Face brick, render, bagged or a painted finish are acceptable.
- C2. Use by preference bulk or reflective insulation in roof systems and fall arrest sarking to improve thermal performance.
- C3. Provide a mix of materials and colours to create visual interest and variety in the streetscape.
- C4. For the parts of the home seen from the street, ensure a combination of materials including but not limited to:
  - feature stonework; and
  - light weight materials such as timber, feature panelling, plywood, pre-finished metal sheeting, etc.
- C5. Use by preference building materials which minimise their impact on the environment. These materials can be from renewable resources, and are:
  - energy efficient;
  - durable;
  - low maintenance;
  - recycled or recyclable; and
  - non-polluting in use, manufacture and disposal.
- C6. Natural colours, such as off whites, creams, browns and greys, are permitted as major external wall colours. The use of stronger accent colours is acceptable for highlighting building elements such as entry porticos, feature materials, etc.
- C7. Roofing materials are to be selected from the following:
  - Low profile concrete or terracotta tiles; and
  - Pre-finished and pre-coloured metal roofing.
- C8. Multi -coloured tiled roofs are not permitted.

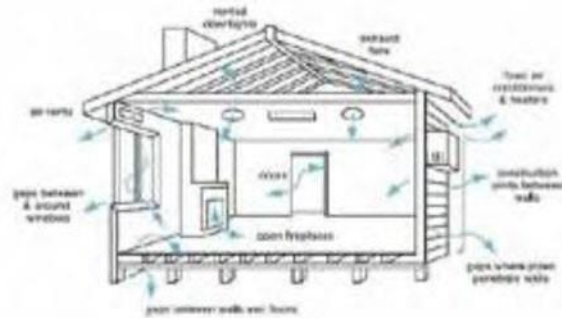

Figure 45: Energy smart house

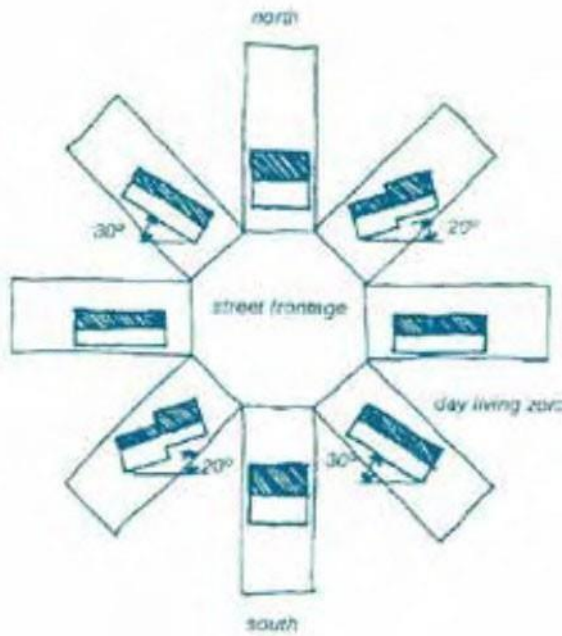

Figure 46: Lot orientation for good solar access

### 3.3.13 Water and Energy Efficiency

#### Objectives

- O1. Design living and working environments that minimise energy and water use; and
- O2. Use passive and active design initiatives to ensure comfortable living environments that respect the principles of ecologically sustainable development.
- O3. Implement sustainable practices in water and energy efficiency.
- O4. Minimise reliance on artificial heating and cooling, and maximise natural lighting.
- O5. To minimise water usage.

### **Controls**

- C1. Ensure all new residential development complies with the requirements of the Building Sustainability Index (BASIX) for energy efficiency. Obtain BASIX Certification prior to the final design submission.
- C2. Take advantage of northerly aspects.
- C3. Achieve cross ventilation. To do so, windows are to be located to take advantage of prevailing winds in summer.
- C4. Design floor layout to allow penetration of light to rooms.
- C5. Incorporate courtyards, light wells and atria to assist natural lighting and ventilation.
- C6. Provide at least double orientation to all dwellings.
- C7. Use building mass and/or building insulation to improve the climatic performance of buildings.
- C8. Ensure all new residential development complies with the requirements of the Building Sustainability Index (BASIX) for water efficiency. Obtain BASIX Certification prior to the final design submission.
- C9. Rainwater tanks are to be sited, and to be of a finish, that does not adversely impact on the amenity of future residents and/or adjoining properties in terms of bulk, scale, design, style, height and location

### **3.3.14 Garages, Car Parking and Driveways**

#### **Objectives**

- O1. Contain the per capita growth in VKT (vehicle kilometres travelled) by achieving higher than normal public transport usage.
- O2. Manage the supply of parking facilities in a manner that supports the use of existing and proposed public transport services.
- O3. Encourage a reduction in the level of vehicular traffic by reducing parking requirements.
- O4. Ensure adequate parking for various land uses which sustain the market viability of the development within Pemulwuy.
- O5. Limit the impact of garages and driveways along streets, to maximise the street address of buildings and to emphasise pedestrian safety.
- O6. Minimise the provision of on-site parking, and to enhance the street activity of the neighbourhood.
- O7. Seek a balance between satisfying a proportion of parking demand onsite, addressing car use reduction objectives and minimising the spread of parking into surrounding streets.
- O8. Facilitate convenient and safe vehicular movement.
- O9. Encourage efficient use of space.

## **Controls**

### On-street parking

- C1. On street parking should be designed to be consistent with the design principles and dimensional requirements of Australian Standards AS2890 and AS1742.
- C2. Provide on-street parking which is well-lit and offers casual surveillance for street security.
- C3. Limit on-street parking to not compromise the streetscape character nor the active streetscape.
- C4. Provide sufficient on-street parking so that garages and carports do not dominate the street frontage.

### Off-street parking

- C5. Minimise off-street parking supply, having regard to:
  - access to public transport (located within 400m);
  - surveys of existing similar developments indicating a lower parking demand;
  - land use synergies with surrounding land uses;
  - complimentary/shared use of parking facilities; and
  - the ability to manage the use of on street parking.
- C6. A minimum of one off-street parking space with at least one enclosed garage is to be provided on each allotment. Three car garages are not permitted.
- C7. Off street parking shall be consistent with the design principles and dimensional requirements of Australian Standards AS 2890.1.
- C8. Where possible, locate parking on the southern side of dwellings or on the down-slope side of sloping lot frontages.

### Garages

- C9. On allotments with direct access from the main street the garage is to be set back at least 5.5m from the property boundary.
- C10. Garage doors are to be panel lift or panel glide.
- C11. Garages should incorporate additional space for storage, such as recesses for bins and recycling.
- C12. Parking may be provided in basements under building footprints. Naturally ventilated semi-basement car parks extending to 1.2m above adjacent ground level are preferred in any under-building parking.
- C13. Prefer garage access from car courts (shared rear access) where it is available.
- C14. The minimum aisle width of car courts shall be 6m adjoining the public road and where accessing parking. This can be reduced to allow for landscaping where vehicle turning movements are not compromised.
- C15. The design of car courts and associated garages is to ensure that vehicles enter and exit in a forward direction.

- C16. On site parking for residential flat building developments is to be provided at a rate not more than:
- 1 space per bed-sit, studio or one bedroom dwelling;
  - 1.25 spaces per two bedroom dwelling;
  - 1.5 spaces per dwelling with three or more bedrooms;
  - visitor parking is to be provided at 0.25 spaces per dwelling and be provided in designated spaces.
  - cycle parking spaces are required within parking areas for Residential flat buildings. For individual houses with 3 bedroom or more, storage spaces in the garage are preferred; and
  - provide a vehicle wash bay of permeable material construction.

Driveways

- C17. Driveway crossings are to be between 3m and 5m wide at the front boundary for single garages and tandem garages.
- C18. Driveway crossings of between 5m and 6m in width for double garages are permitted; however, at least 25% of the width of the allotment must be soft landscaping. Driveway levels and vehicle crossings from street to front boundary must be submitted and approved by Council.
- C19. Driveway crossings must be plain concrete. Refer to Figure 47.
- C20. Driveway materials from the garage to the front boundary include paving, coloured concrete, patterned or stencilled concrete. Plain concrete driveways and car tracks will not be approved.
- C21. A pedestrian pathway is required from the front boundary to the entry of the dwelling, and must be separate from the driveway.
- C22. A vehicle crossing application must be made to Council for proposed works within the nature strip.
- C23. 500mm of planting is to be provided between the side boundary and the driveway.

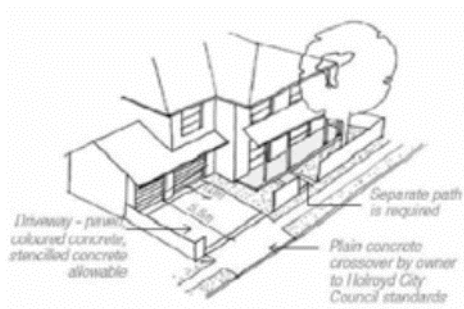

Figure 47: Driveway crossover

### 3.3.15 Fencing

#### **Controls**

*Note: Consider specific requirements for lots with sloping land.*

#### Front fencing

- C1. The front fence piers and base are to be constructed of rendered, bagged or face brickwork to match the style of the home, with a light weight see-through infill.
- C2. Figure 48 shows the required dimensions of front fencing.
- C3. Front fencing must return along the boundary to the front building facade.
- C4. Fencing must step down to meet the slope of your allotment as shown in Figure 49.
- C5. Front fencing can be used as a retaining feature.
- C6. Maximum height of 1.2m from natural ground on the street side of the fence, except where slopes exceed 1:8.

#### Side and rear fencing

- C7. The provision of side and rear fences is mandatory.
- C8. Side and rear fencing is to be 1.8m high lapped and capped timber fencing, or must be reduced to 1.5m high when built on top of a retaining wall. Colorbond fencing or similar is not permitted. Where the retaining wall exceeds 1.2m, the combined wall and fence should not exceed 2.4m.

*Note: See Section 3.3.2 Elevated Sites (Steep Land) in Pemulwuy - Lots with Front to Back Slopes, for exceptions.*

- C9. The side fencing and gate is to finish on the wall built to the boundary or 1m behind the front of the home. No side fencing is to be forward of the building line (at which point it becomes "front fencing" - see above).
- C10. Maximum height of 1.8m from natural ground on the street side of the fence.
- C11. An additional 300mm on top of the required 1.8m high lapped and capped timber fencing may be required to minimise overlooking into adjacent homes. Refer to elevated site requirements.

#### Corner/Secondary Street Fencing

- C12. The piers and base are to be constructed of rendered, bagged or face brickwork to match the style of the home and not to exceed 1.8m above the level of the adjacent footpath or verge.
- C13. Stained or painted timber infill panels. Hebel or similar aerated concrete product may be used as a lightweight masonry option, particularly where nearby easements for services are on the lot.
- C14. Figure 50 shows required dimensions of corner or secondary street fencing.

C15. On sloping land, the height of fencing must step to follow the slope of your allotment as shown in Figure 49. The low wall plinth must be no greater than 0.6m at the highest step.

C16. Fencing can be used as a retaining feature.

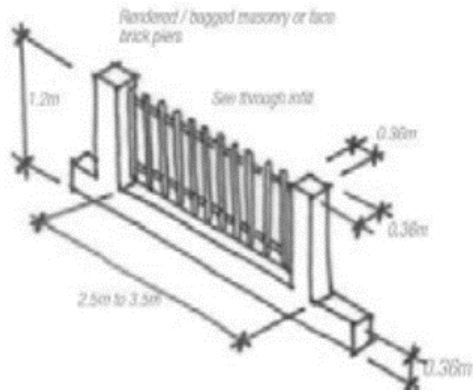

Figure 48: Front fence detail

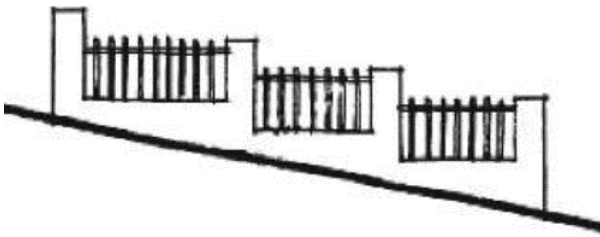

Figure 49: Sloping fence detail

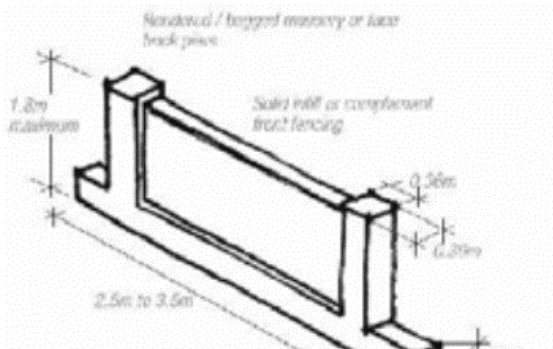

Figure 50: Corner allotment side fencing



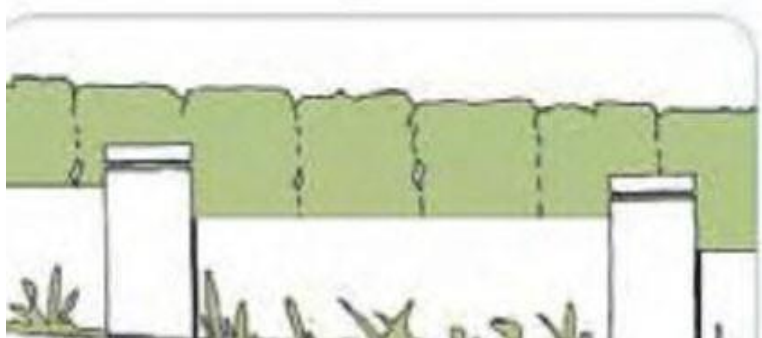

Figure 51: Lakefront front boundary fencing

### 3.3.16 Adaptable and Affordable Housing

#### Objectives

- O1. Ensure dwellings within Pemulwuy are capable of being adapted to accommodate the needs of people with limited mobility.
- O2. Provide some private market affordable housing within Pemulwuy.
- O3. Offer affordable housing that supports the needs of changing populations.

#### Controls

- C1. Ensure that 20% of multi-unit housing, shop-top housing and mansion house apartments are compliant with *Class C – Adaptable Housing Features* as set out in Australian Standard AS4299.
- C2. Ensure that 100% of aged housing is compliant with *Class C – Adaptable Housing Features* as set out in Australian Standard AS4299.
- C3. Ensure that 100% of adaptable housing is compliant with *Adaptable Housing Class A or B*.
- C4. Council to encourage some private market affordable housing products in an integrated manner (i.e. not in clusters but distributed throughout the larger site), particularly in the latter stages of the development.

### 3.3.17 Safety, Security and Lighting

#### Objectives

- O1. Address the principles of *Crime Prevention through Environmental Design* (CPTED).
- O2. Design with safety and security as a key concern.
- O3. Provide public open spaces with a strong physical connection to housing so as to achieve a clear ownership of public space. It is recognised that well used and valued public open spaces reduce opportunities for crime and increase risk for potential offenders.
- O4. Avoid the misapprehension that a public park is a private space.

## Controls

- C1. Edge open space areas with streets and housing, providing clear sight lines from private residences to public domain areas.
- C2. Identify lots edging open spaces as suitable for increased densities, thereby maximising the number of dwellings which overlook open spaces. Incorporate passive open space surveillance into lot layout and design of residences, including balconies, porches, etc.
- C3. Provide parking for open spaces along illuminated public streets edging parks rather than consolidating car parking within the parks themselves. This is designed to increase casual surveillance of parked vehicles and their occupants.
- C4. Design parking areas at recreational locations to avoid loitering.
- C5. Design public streets edging open spaces to provide safe, well lit pedestrian routes, eliminating the need to circulate across parks at night.
- C6. Provide adequate lighting in recreational areas, parklands, cycleways, and pedestrian thoroughfares.
- C7. Clearly articulate public spaces with public streets.
- C8. Control vehicle access to public open space by the use of low fencing or bollards on accessways to the park edge. Avoid the use of high gates, fences and enclosures.
- C9. Design street furniture and amenities to be vandal resistant, with walls treated with sacrificial coatings to deter and remove graffiti.
- C10. Ensure landscaping maintains view corridors and clear sight lines.
- C11. Locate bus stops in safe, well-lit locations with good surveillance.
- C12. Adequately light entrances to buildings, with lighting that does not produce shadows.
- C13. At building entrances, ensure clear sight lines are not be obscured by landscaping or other obstacles.
- C14. Ensure all dwelling entries are clearly visible from the street by day and night.
- C15. Design first floor uses to overlook the street and car parking areas.
- C16. Ensure private landscaping does not provide opportunities for concealment e.g. along pathways or adjacent to service areas.
- C17. Minimise the length of car courts accessing rear garages, with clear sight lines provided to/from the public road. In some places, mews dwellings above rear garages will increase the potential for passive surveillance. Provide sensor lighting mounted at appropriate locations within the car courts.
- C18. Provide facilities at bus stop locations to encourage increased use and safety. Such facilities shall include:
  - bus lay-bys and speed controls to protect pedestrians, depending on the particular road design; and

- shelters and seating for waiting passengers, display of timetable information and street lighting for security.

### 3.3.18 Bushfire Protection

#### **Objectives**

- O1. Provide residential development with adequate protection from the potential bushfire hazard.

#### **Controls**

- C1. Development must comply with *Planning for Bushfire Protection* (NSW Rural Fire Service: 2019) or subsequent amendments.
- C2. In the case of the riparian corridor, provide an Outer Protection Area and Inner Protection Area in the form of fuel reduced zones and perimeter road.

### 3.3.19 Salinity

#### **Objectives**

- O1. Minimise disturbance to natural hydrological systems as a result of development.
- O2. Provide for appropriate management where urban development may affect the process of salinisation.
- O3. Provide for appropriate management where the land is affected by groundwater salinity.
- O4. Prevent damage to buildings and infrastructure caused by salinity.

#### **Controls**

- C1. Consent must not be granted for development to which this clause applies unless the consent authority has considered:
- the impact of the proposed development on local and regional salinity processes; and
  - the impact of salinity on the proposed development. In particular, that appropriate measures have been carried out to the Engineer's satisfaction, including:
    - use of saline-resistant building materials;
    - treatment of outer walls below ground; and
    - drainage deviation.

### 3.3.20 Servicing

#### **Objectives**

- O1. Minimise the impact of services on the public domain.
- O2. Ensure efficient storage and collection of waste and quality design of facilities.

#### **Controls**

- C1. Provide each dwelling with a secure external clothes drying area with access to sunlight and breezes, screened from the public domain.

- C2. Locate adequate rubbish and recycling areas where they are convenient and accessible:
- adjacent to access lanes or 'little streets' where they exist;
  - not forward of the prevalent built edge to the street; and
  - screened from the public domain
- C3. Provision shall be made within all development for the convenient movement of bins to streets for collection.
- C4. In addition to garages, the adequate storage of bulky goods in multi-unit housing is required at a rate of:
- 7.5 cubic metres for a studio/one bedroom unit;
  - 10 cubic metres for a two bedroom unit; and
  - 12.5 cubic metres for units with three or more bedrooms.
- C5. Antennae, satellite dishes, water tanks, service metres and solar heating should be sited to minimise their impact on the public domain.

### 3.3.21 Telecommunications

#### **Objectives**

- O1. Ensure the capacity for advanced telecommunications systems within Pemulwuy.

#### **Controls**

- C1. Demonstrate the provision of telecommunication infrastructure:
- to all dwellings, community buildings and commercial premises;
  - that has the capacity to support multiple telecommunication services; high speed internet (including broadband), voice and data systems;
  - that can be duplicated and upgraded in a cost effective and timely manner; and
  - that is located underground.

### 3.3.22 Dwelling Types – Summary

An abbreviated form of the essential differences between Types A, B, C, D and M, compared between Pemulwuy North and Pemulwuy South is shown in the following table:

Table 1b: Dwelling types

	Pemulwuy North	Pemulwuy South
Side setbacks Type D South *Aged Housing *Apartments *Townhouses *Residential Flat Buildings (RFB's)	Type A detached dwelling = 0.9m to both. Type B dual occ. Only = 0.9 + 0m. Type C townhouse/rowhouse = 0m to both. Type D RFB/Mansion House Apartment = 3m*	Type A detached dwelling + courtyard = 0.9m to both. Type B dual occ. Only = 0.9 + 0m. Type C low density townhouse/rowhouse - 0m to both. Type D Apartment/RFB/Aged + higher density townhouses = 3m* Type M Mixed use development (Residential) = 3m*  *Type M = Aged housing; Apartments integrated with Retail / commercial or Community Facilities; RFB's.
Lot size	Type A = 400 - 600m <sup>2</sup> Type B = 300 - 500m <sup>2</sup> Type C = 200 - 300m <sup>2</sup> Type D = 100 - 250m <sup>2</sup> Type D Mansion House Apartment = 80-150m <sup>2</sup> (total lot 1350m <sup>2</sup> )	Type A = 300 - 600m <sup>2</sup> Type B = 250 - 400m <sup>2</sup> Type C = 200 - 300m <sup>2</sup> Type D = 100 - 250m <sup>2</sup> Type M Mixed Use (Res) = 100 - 250m <sup>2</sup>
Frontage	Type A = 15 - 20m Type B = 10 - 14m Type C = 6 - 9m Type D Mansion House Apartment = 30m	Type A = 9 - 16m Type B = 6 - 12m Type C = 6 - 9m
Min. "Landscaped soft area" (Soft/pervious) as % of site area	Type A = 30% Type B = 30% Type C = 30% Type D Mansion House Apartment = 20%	Type A = 20% Type B = 20% Type C = 20%  Types D/M = 20%
Front Setbacks	3-4.5m (depending on the vicinity of riparian public open space)	3m
Rear setbacks	1 storey = 6m 2 storey = 8m  If rear garage (as below) = 3m from garage to dwelling	North-South lots: Lot depth max. 35m = 6m Lot depth >35m = 8m East-West lots: Little streets access = 3m from garage to dwelling Other streets = 4.5m

### 3.4 Subprecinct Controls – Pemulwuy North

The following controls apply specifically to the Pemulwuy precinct predominantly to the north of Butu Wargun as identified in Figure 1.

#### 3.4.1 Height Limits

##### Objectives

- O1. Achieve building heights and forms that respect the streetscape and heritage values of Prospect Hill, and that assist in establishing an attractive streetscape.

##### Controls

*Note: The maximum height for a dwelling house (in metres) is detailed within Cumberland Local Environmental Plan 2021, as a written statement and associated maps.*

- C1. Height limits (expressed as storeys) are stipulated on Figure 52 and should be read in conjunction with the Height of Building map associated with *Cumberland Local Environmental Plan 2021*.
- C2. External wall height controls relate to site falls of up to 1 in 8. For sites steeper than 1 in 8 relaxation of these controls may be permissible. See Fencing in Section 3.3.15.
- C3. The building elevation facing the street is to be a minimum of two storeys unless designated as a 'single storey permitted development'.

##### Single storey zone

- C4. Buildings are limited to single storey height, with a maximum external wall height of 4m, with roof terraces or attic rooms permitted;
- C5. Maximum building height is to be 6m.

##### Part one/two storey zone

For part one/two storey sites adjacent to Prospect Hill:

- C6. The maximum external wall height is 4m at the front and 6.5m at the rear;
- C7. The maximum building height is 9m and is not to exceed RL 79.
- C8. Maximum building height may be permitted only where it can be demonstrated that the views into and within the site relating to the height, bulk, and scale of the dwelling are not compromised.

##### Two storey zone

- C9. Two storey height limit, with a maximum external wall height of 6.5m.
- C10. Maximum building height is to be 9m.
- C11. On sites with slopes greater than 1:8, maximum external wall height may be increased to 7.5m and building height to 10m dependant on scale, bulk, privacy and overshadowing issues.

Three storey zone

- C12. Three storey height limit, with a maximum external wall height of 10m.
- C13. Maximum building height is to be 12.5m.
- C14. Three storey development is a minimum and maximum for the zone fronting the east/west link road adjacent to the village centre.

*Note: The minimum floor to ceiling height of a dwelling is controlled by Part B of this DCP.*

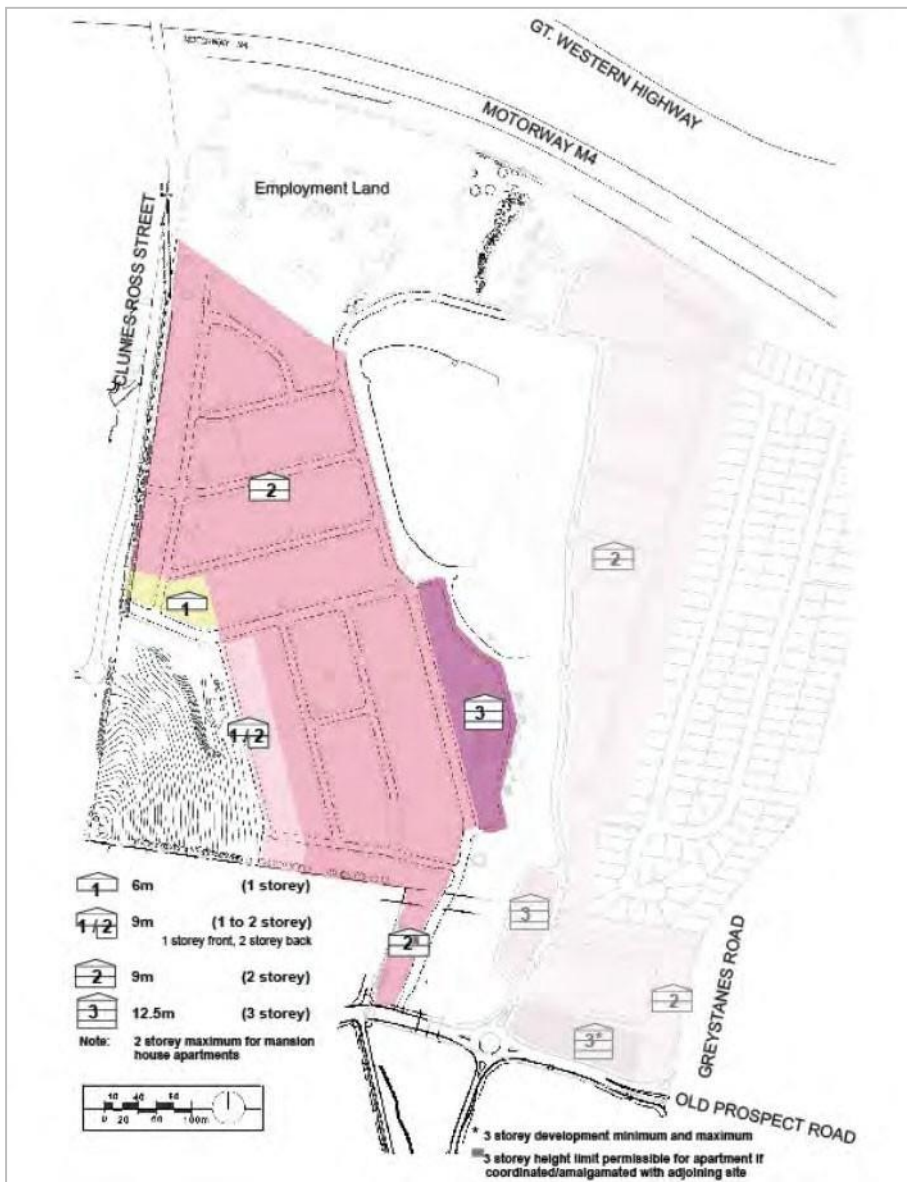

Figure 52: Building height - Pemulwuy North

### 3.4.2 Setbacks

#### Objectives

- O1. Provide setbacks to reinforce the vegetated character of the public domain with front gardens.
- O2. Establish continuous gardens in deep soil planting in the centre of blocks to increase the amenity of private blocks.
- O3. Ensure no loss of amenity for neighbours.

#### Controls

- C1. Provide 3m - 4.5m front setbacks to dwellings as specified in Figure 39 (Private Open Space).
- C2. Provide a minimum 5.5m setback to garages from the front street boundary.
- C3. Front porches or verandas are allowed to encroach within one third of the front setback area in which instance the porch or verandah must be unroofed.
- C4. Rear setback to be 6m to single storey elements and 8m to 2 storey elements.
- C5. Rear garages can be built to rear boundary alignment where accessed through shared vehicular access. Any studios over garages are not to overlook or overshadow adjacent dwellings or private open space.
- C6. Provide a minimum side setback of 0.9m both sides for detached dwellings and 0.9m minimum for duplex and courtyard houses with a zero lot line permitted one side. No side setbacks required for townhouses/row houses.
- C7. Apartment Buildings (Type D housing): Side setbacks provide for minimum separation distances in accordance with Section 3.3.9 (Visual and Acoustic Privacy), with a minimum of 3m.
- C8. Side setback to secondary street frontage shall be 1.5m minimum.



Figure 53: Habitable room setback from employment lands



### 3.4.3 Development Adjacent to Other Precincts

#### Development adjacent to employment lands

##### **Objectives**

- O1. Ensure suitable residential amenity for dwellings adjacent to Employment Land (as shown in Figure 80).
- O2. Minimise the impact of noise from the proposed former CSIRO Employment Land on the proposed residential areas.

##### **Controls**

- C1. Habitable rooms/buildings are not permitted within 10m of the rear boundary (refer to Figure 53). Improved glazing is required on windows facing the Employment Land.
- C2. Setbacks and landscaping buffer within the Employment Lands must also protect residential amenity.

#### Employment land uses

- C3. Noise attenuation to the adjoining residential lands is to be achieved by the appropriate siting of employment buildings to the north (refer to 'Noise Impact Assessment' – Richard Heggie and Associates).
- C4. If required, additional acoustic treatment is to extend along the northern boundary between Clunies Ross Street and the Employment Land buildings, the nature of which is to be determined at Development Application stage based on the advice of an appropriately qualified acoustic consultant.

#### Noise monitoring

- C5. Compliance noise monitoring shall be conducted by Stockland to demonstrate compliance with established noise goals for both traffic and industrial noise. Internal and external noise monitoring shall be conducted by Stockland Corporation Ltd on site to establish that the implemented noise controls will result in an acceptable acoustic amenity in noise affected areas.

#### Traffic noise

- C6. The installation of a noise logger on site for a period of a least 1 week is required where a noise barrier is adopted to achieve established noise criteria.

#### Industrial noise

- C7. Ensure that the noise from employment related uses does not exceed stated criteria in Section 3.10 - Environmental Management entitled Industrial Noise Criteria for Residences adjoining Clunies Ross Street when measured at the residential receiver.
- C8. Operator attended measurements, supplemented by noise logging where appropriate, on site for a period of a least one week is required where a noise barrier is adopted to achieve established noise criteria.

Interface to existing residential to east

**Objective**

- O3. Create new dwellings that do not create undue amenity impacts to the rear of existing dwellings in terms of overshadowing, overlooking, visual impacts or density/bulk of development.

**Controls**

- C9. Provide a minimum rear garden zone setback of 6m between the eastern site boundary and the single storey rear elements.
- C10. Provide a minimum rear setback of 8m between the eastern boundary and the two storey elements.
- C11. Ensure that new development does not cause undue loss of visual privacy or undue overshadowing to rear of existing gardens and dwellings.
- C12. New dwellings to moderate building bulk with generally single storey rear elements.
- C13. Orientate windows of upper levels northwards rather than eastwards on rear elements where possible.

**3.5 Subprecinct Controls - Pemulwuy South**

The following controls apply specifically to the Pemulwuy precinct predominantly to the south of Butu Wargun as identified in Figure 2.

**3.5.1 Height Limits**

**Objectives**

- O1. Achieve building heights and forms that respect the streetscape and heritage values of Prospect Hill, and that assist in establishing an attractive streetscape.
- O2. Site and design development proposals that are in proximity to the Prospect Hill State Heritage Registered Area to ensure that views to and from the Prospect Hill ridgeline are maintained.

**Controls**

*Note:*

- *The maximum height for a dwelling house (in metres) is detailed within Cumberland Local Environmental Plan 2021, as a written statement and associated maps.*
  - *The minimum floor to ceiling height of a dwelling is controlled by Part B of this DCP.*
  - *Cumberland Local Environmental Plan 2021 applies to views to and from Prospect Hill.*
- C1. Height limits (expressed as storeys) are stipulated on Figure 55 and should be read in conjunction with the Height of Building map associated with *Cumberland Local Environmental Plan 2021*.
- C2. External wall height controls relate to site falls of up to 1 in 8. For sites steeper than 1 in 8, relaxation of these controls may be permissible. Refer to Figure 55.

Two storey zone

- C3. Two storey development is permissible within this zone.
- C4. Maximum external wall height is to be 6.5m.
- C5. Maximum building height is to be 9m.
- C6. Where basement parking is proposed, on sites with slopes greater than 1:8, maximum external wall height can be increased to 7.5m and building height to 10m.

Two storey little street zone

- C7. Two storey development is permissible within this zone.
- C8. Maximum external wall height is to be 6.5m; and
- C9. Maximum building height is to be 9m.

Two storey roof zone

- C10. Two storey development with attic rooms or roof terraces permissible within this zone.
- C11. Maximum external wall height is to be 7.5m.
- C12. Maximum building height is 10m.

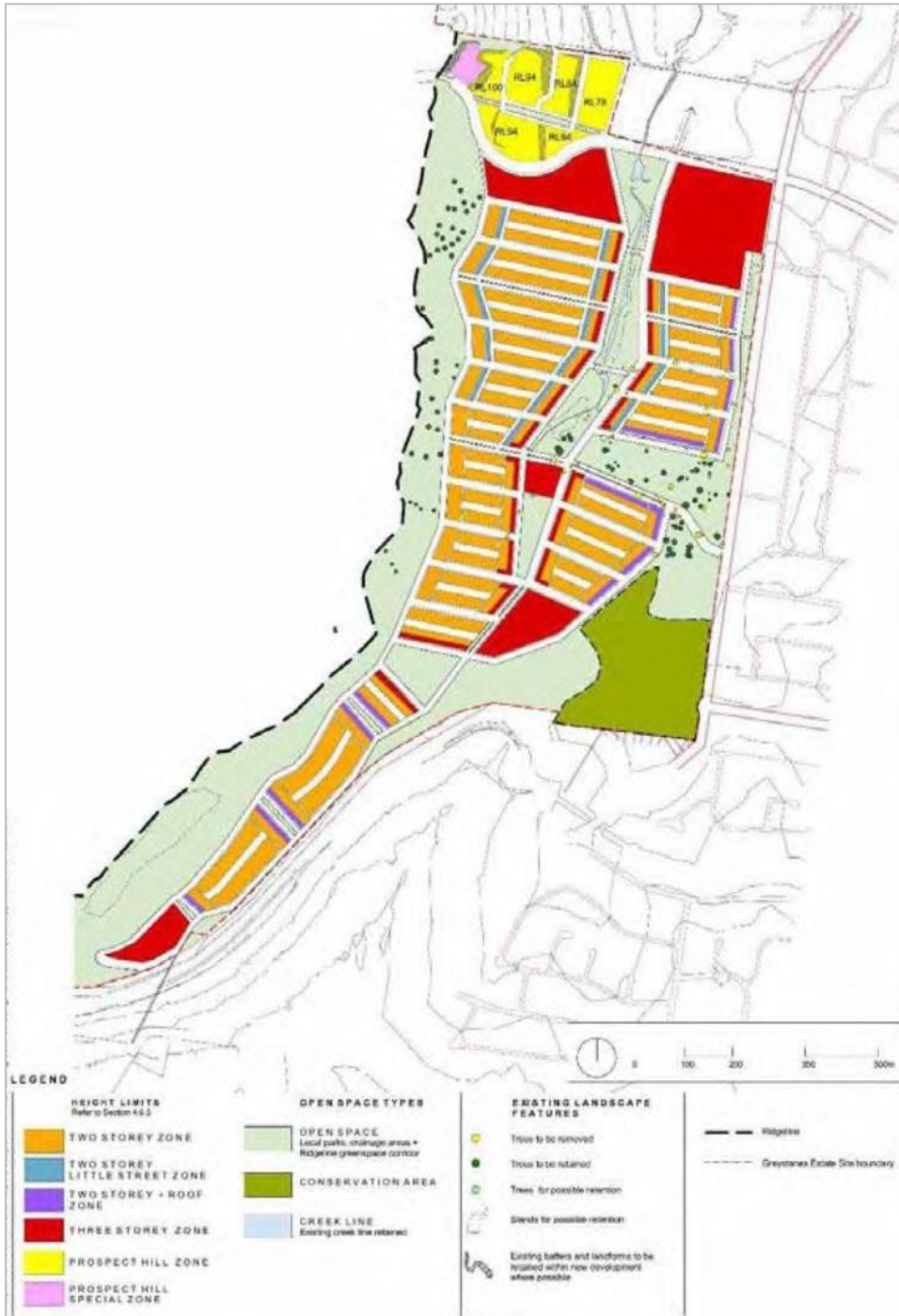

Figure 54: Height control strategy - Pemulwuy South

Three storey zone

C13. Three storey development permissible within this zone.

C14. Maximum external wall height is to be 10m.

C15. Maximum building height is to be 12.5m.

Prospect Hill development area

C16. Maximum building height is not to exceed the RLs stipulated in Figure 56.

C17. Three storey development is permissible in this zone, where achievable.

C18. The maximum external wall height is to be 10m.

Prospect Hill special area

C19. Maximum height of development to be determined in consultation with the Heritage Office.

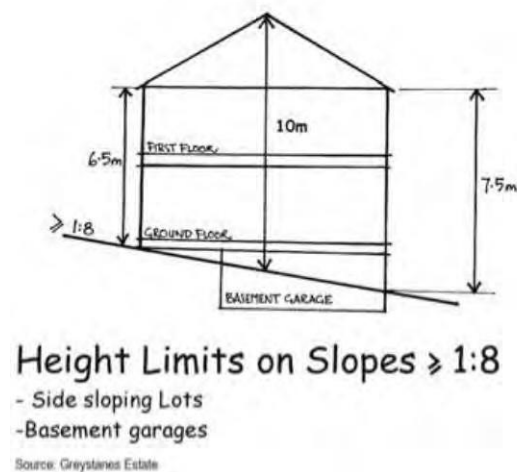

Figure 55: Height limits on slopes  $> 1:8$

3.5.2 Setbacks

**Objectives**

- O1. Provide setbacks to reinforce the vegetated character of the public domain with front gardens.
- O2. Establish continuous gardens in deep soil planting in the centre of blocks to increase the amenity of private blocks.
- O3. Ensure no loss of amenity for neighbours.

**Controls**

- C1. Provide a minimum 3m front setback to dwellings.
- C2. Provide a minimum 5.5m setback to garages from the street frontages.
- C3. Provide the following rear landscaped setbacks to north-south lots:
  - up to 35m depth requires a minimum of 6m from rear boundary; and
  - greater than 35m depth requires a minimum of 8m from the rear boundary.
- C4. Provide the following rear setbacks to east-west lots:
  - lots accessible from little streets require a minimum of 3m from rear of garage zone; and
  - lots accessible from public streets require a minimum of 4.5m from the rear boundary.

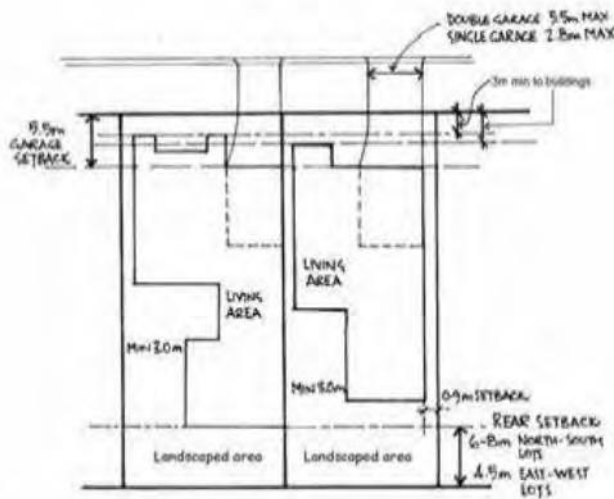

**Illustrative Layout Only**

Source: Croystanes Estate

Figure 56: Type A detached dwelling - Pemulwuy south - setbacks layout

### 3.6 Transport Plan

Principles for a Transport Plan:

#### Objectives

- O1. Address transport targets.
- O2. Establish guiding principles for design and layout of the site consistent with increasing the mode split towards public transport and non-private vehicle usage and minimise vehicle kilometres travelled (VKTs).
- O3. Provide for all modes of transport which are integrated into the surrounding network of each mode.
- O4. Identify a range of transport infrastructure which addresses site requirements including the staging and funding proposals.
- O5. To identify pedestrian links to the Transitway and bus route networks.

#### Controls

- C1. Reduce the mode split of 'car as driver' for the journey to work by at least 10% (e.g. from 75% to 65%) compared to the existing surrounding area.
- C2. Reduce the total VKT (vehicle kilometres travelled) to be generated by the proposed development by at least 5% below that which would be generated by a 'conventional' approach to development.

#### 3.6.1 Regional Requirements

##### Objectives

- O1. Provide regional transport infrastructure which will achieve the transport targets established by *SEPP (Western Sydney Employment Area) 2009*.
- O2. Develop transport infrastructure that will service the needs of the site and integrate into an improved regional transport network.
- O3. Provide infrastructure which recognises the need to integrate all modes of transport including public transport, private vehicle transport, walking and cycling.
- O4. Develop measures to mitigate potential transport impacts generated by the development of Pemulwuy on surrounding areas.

##### Controls

- C1. Provide regional (and local) transport infrastructure improvements that are consistent with:
  - The Deeds of Agreement between Stockland and the Roads and Maritime Services;
  - The Deeds of Agreement between Boral Resources (NSW) Pty Ltd and the Roads and Maritime Services; and
  - Council's relevant Local Infrastructure Contributions Plan.

### 3.6.2 Transport Design Guidelines – Land Use Location

#### **Objectives**

- O1. Generate efficient travel patterns across the site to reduce VKTs.
- O2. Maximise the use and support the viability of public transport services.
- O3. Avoid potential conflicts between various land uses.
- O4. Site and design land uses to accommodate mobility impaired persons.

#### **Controls**

- C1. Provide appropriate and conveniently located services (such as shops) and open space as shown on the Figures 58 and 59 to reduce trip length and to encourage use of pedestrian/ cycleway networks.
- C2. Ensure that land uses are well integrated with public transport stops, nodes and interchanges so as to provide safe, attractive and inviting environments.
- C3. Separate residential and employment precincts to avoid potential road function conflicts and unnecessary through traffic.
- C4. Locate higher density development in close proximity to transport nodes.
- C5. Locate the village centre as shown on the concept plan to avoid unnecessary traffic infiltration in residential streets. The layout strategy is shown in Figure 59.



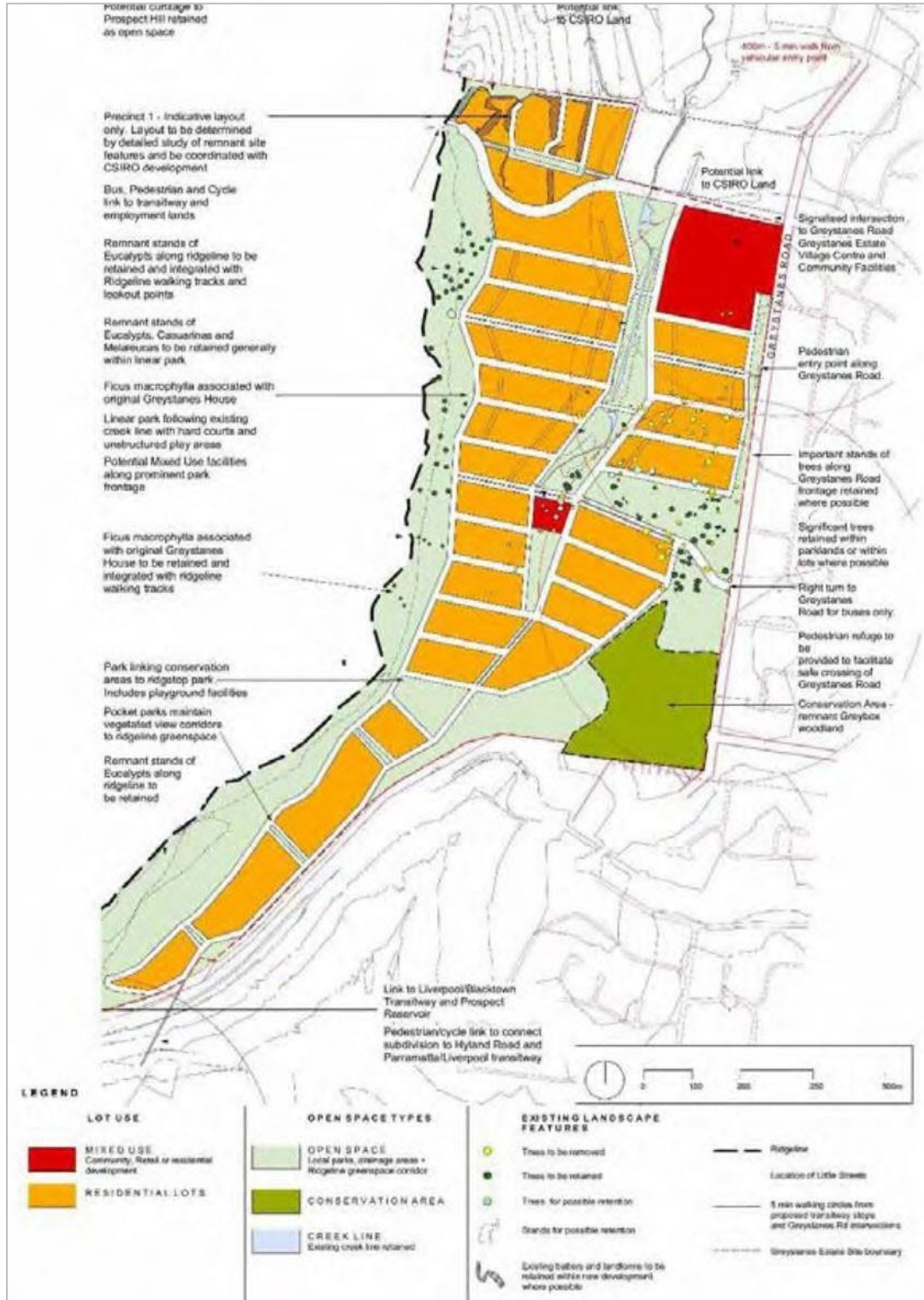

Figure 57: Urban Design Strategy - Pemulwuy South

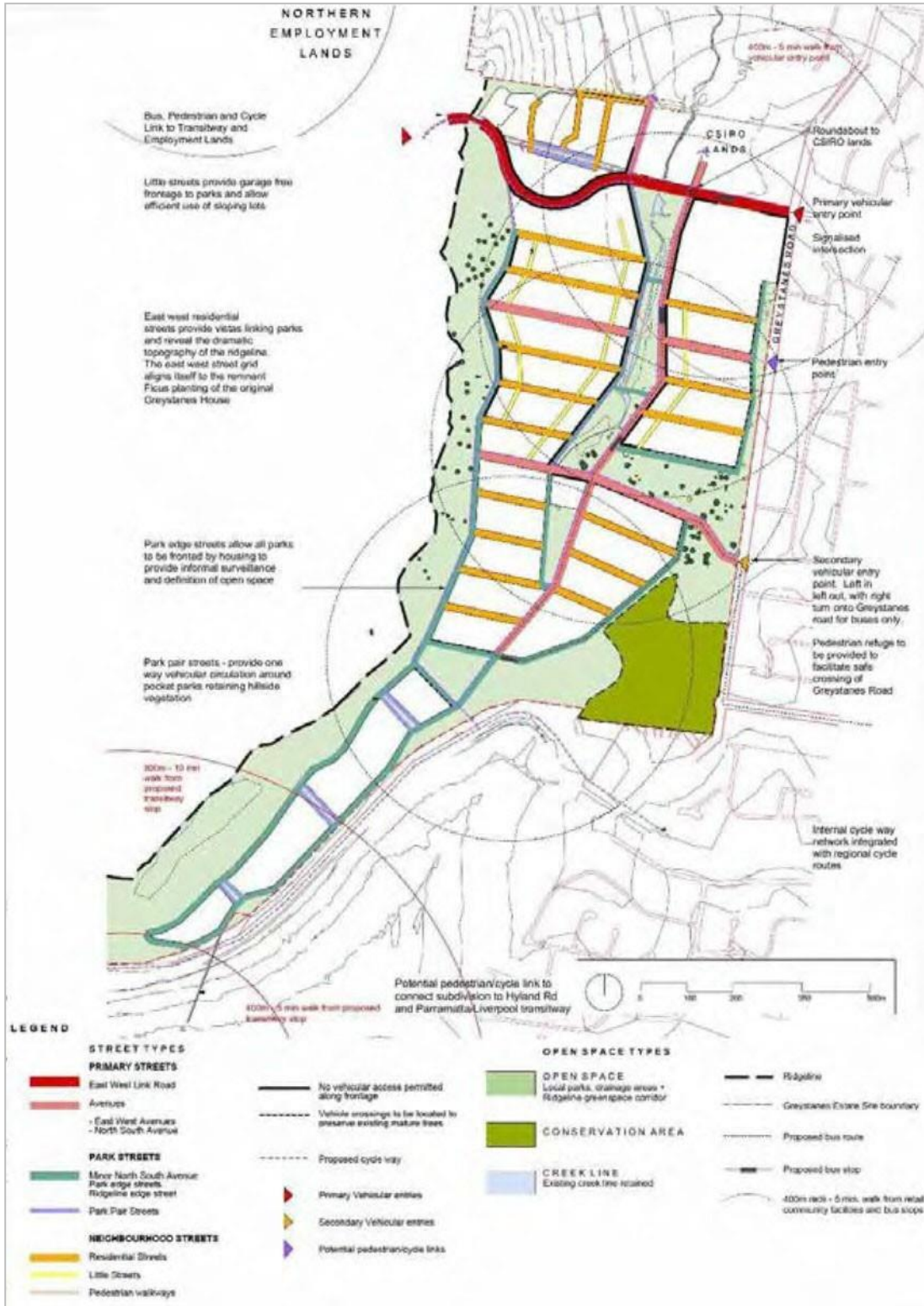

Figure 58: Road hierarchy layout - Pemulwuy South

### 3.6.3 Access to Pemulwuy

#### Objectives

- O1. Ensure safe access to Pemulwuy.
- O2. Provide access through Pemulwuy by improving the regional road network, including accessing Pemulwuy from Clunies Ross Street, linking through to Butu Wargun Drive.
- O3. Design and construct roads in order to control the speed and noise of the anticipated traffic volume and contribute to safety.
- O4. Ensure that walking and cycling are encouraged and not impeded by road design.

#### Controls

- C1. Ensure that intersections into Pemulwuy are designed with sound traffic planning principles and relevant guidelines including, but not limited to:
  - *RMS - Road Design Guide*;
  - *AUSTROADS – Guide to Traffic Engineering Practice*.
- C2. Locate vehicular access and linkages to Pemulwuy as shown on:
  - Figure 60 (Street Types - Pemulwuy North); and
  - Figure 59 (Road Hierarchy Layout - Pemulwuy South).
- C3. Cowra Street is to provide for pedestrian and cyclist access only from Pemulwuy. Future subdivision layout is to maintain the opportunity for a vehicular link to Cowra Street.
- C4. Consider construction of a northern connection from Butu Wargun Drive to Clunies Ross Street.
- C5. Provide cycleway and footpath networks consistent with Section 3.6.9 Pedestrian and Cycle Routes.

### 3.6.4 Public Road Design

#### Objectives

- O1. Create a clearly defined road hierarchy based on use, function, amenity and geometric design requirements.
- O2. Maximise the efficiency of the Pemulwuy road network to reduce trip lengths and enhance the viability of public transport.
- O3. Allow efficient movement through Pemulwuy for regional traffic while discouraging such traffic into the residential areas.
- O4. Provide a safe road network for all modes using the roads including private and public transport, cyclists, pedestrians and mobility impaired persons.
- O5. Design streets that enhance the physical and visual connectivity of neighbourhoods.

#### Controls

- C1. The internal road network layout should be sufficiently permeable for convenient pedestrian and local vehicle movement. However, it should also be sufficiently constrained to discourage non-essential traffic from entering the residential precincts.

- C2. Detailed design of the road network (e.g. intersection layout, pavement materials) should be consistent with the traffic engineering principles of the *RMS - Road Design Guidelines* or *AUSTROADS Guide to Traffic Engineering Practice*. See Figure 59 (Pemulwuy North) and Figure 58 (Pemulwuy South) for an indicative road layout.
- C3. The design of roads should seek to minimise the traffic noise impact on adjacent properties particularly at approaches to residential areas.
- C4. Street reservations shall be used to accommodate landscaping, run-off treatment and infrastructure such as integrated underground services reticulation.
- C5. The design of roads and bridges should seek to accommodate, whenever possible, the continuity of vegetation corridors and habitat to promote fauna movements.
- C6. Road design principles are summarised in C7 which address the functional needs of traffic, pedestrians and cyclists. Figures 60 to Figure 65 shows street sections. These requirements do not apply to private access ways.
- C7. The design of the roads should minimise the amount of cut and fill and to minimise impacts on salinity.
- C8. Trees planted within the roadway and road reserve may be supported by two poles until sufficiently established.
- C9. Traffic flow is to be controlled in residential areas to 50 km/h and below (whilst maintaining the ability for street sweeping) through implementation of the following measures:
- low profile, landscaped roundabouts at major residential intersections;
  - on-street parking used as an anticipated hazard through the action of parking cars;
  - eliminating opportunities for vehicles to cross directly over intersections by staggering junctions, particularly local streets;
  - overall street lengths are kept to a minimum to reduce potential for acceleration;
  - median strips enclosing roadway carriageway restricting traffic to a single width eliminating overtaking and reducing overall speed;
  - defined bus routes along the collector roads will control the flow of traffic by creating temporary traffic obstacles and slowing traffic, meaning bus bays within residential precincts to be used only when absolutely necessary;
  - planting in median; and
  - planting in parking lanes.



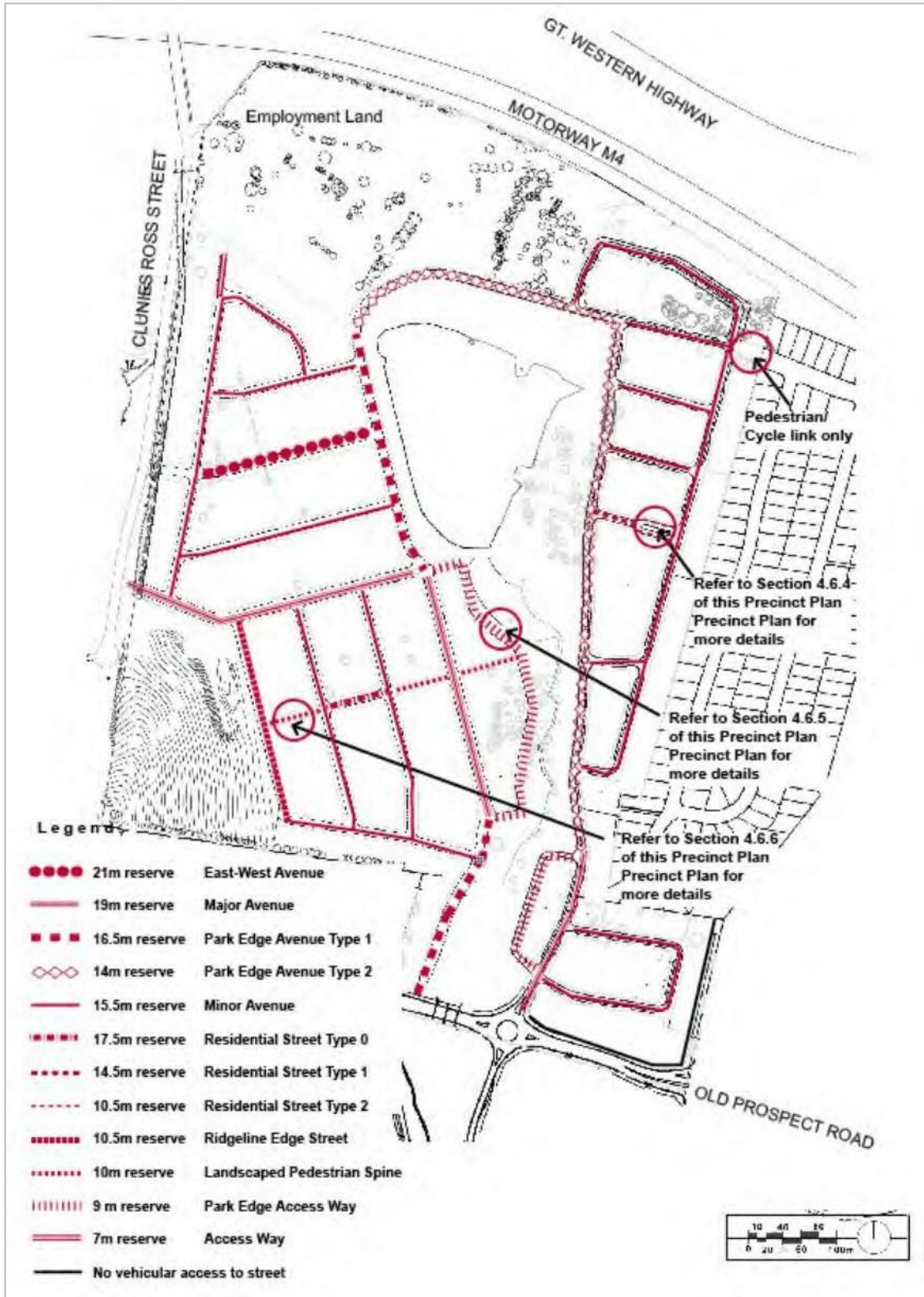

Figure 59: Street types - Pemulwuy north

### 3.6.5 Public Road Designs – Pemulwuy North

#### **Controls**

##### East-West avenues (Figure 58)

- indicative traffic volume – 3000– 7000 vehicles per day;
- 21m road reserve;
- 14m carriageway width;
- one through traffic lane of 3.5m, provided in each direction;
- parking provision in carriageway or indented between street trees on both sides; and
- 1.5m footpath width on one side, 2.9m footpath/cycleway on other.

##### Major avenue

- indicative traffic volume – 3,000 – 7,000 vehicles per day;
- 19m road reserve;
- 12m carriageway width;
- one through traffic lane of 3.5m, provided in each direction;
- parking provision in carriageway indented between street trees on both sides; and
- 1.5m footpath on each side.

##### Park edge avenues type 1

- indicative traffic volume – 300 – 3,000 vehicles per day;
- 16.5m road reserve;
- 12m carriageway width;
- one through lane of 3.5m, provided in either direction;
- parking provision in carriageway indented between street trees on both sides; and
- 1.5m minimum footpath width on residential side. Cycleway/footpath in reserve.

##### Park edge avenues type 2 (Figure 59)

- indicative traffic volume – 300 – 3,000 vehicles per day;
- 14m road reserve;
- 9.5m carriageway width;
- one through lane of 3.5m, provided in either direction;
- parallel parking provision in carriageway indented between trees on residential side; and
- 1.5m minimum footpath width on residential side. Cycleway/footpath in reserve.

##### Minor avenues

- indicative traffic volume – 300 – 3,000 vehicles per day;
- 15.5m road reserve;
- 8.5m carriageway width;
- parallel parking provision in carriageway indented between trees on one side; and
- 1.2m minimum footpath width on both sides.

##### Residential street type 0

- indicative traffic volume – 50 – 300 vehicles per day;
- 17.5m road reserve;
- 7.5m carriageway width; and
- 1.2m minimum footpath width on both sides.

Residential street type 1

- indicative traffic volume – 50 – 300 vehicles per day;
- 14.5m road reserve;
- 7.5m carriageway width; and
- 1.2m minimum footpath width on both sides.
- Residential Street Type 2 (Figure 62)
- indicative traffic volume – 50 – 300 vehicles per day;
- 10.5m road reserve;
- 5.5m carriageway width;
- one way access; and
- 1.2m minimum footpath width on both sides.

Ridgeline edge streets

- indicative traffic volume – up to 50 - 300 vehicles per day;
- 10.5m road reserve;
- 6m carriageway width;
- one way access;
- 1.2m footpath; and
- cyclists to share road with vehicles.

Park edge access way

- indicative traffic volume – up to 20 - 50 vehicles per day;
- 9m road reserve;
- 5.5m carriageway width;
- 1.2m footpath on residential side;
- one way access;
- one parking lane on residential side;
- 2.5 - 3m pedestrian/cyclist path in the park reserve on eastern side; and
- 1.2m footpath in the park reserve on western side.

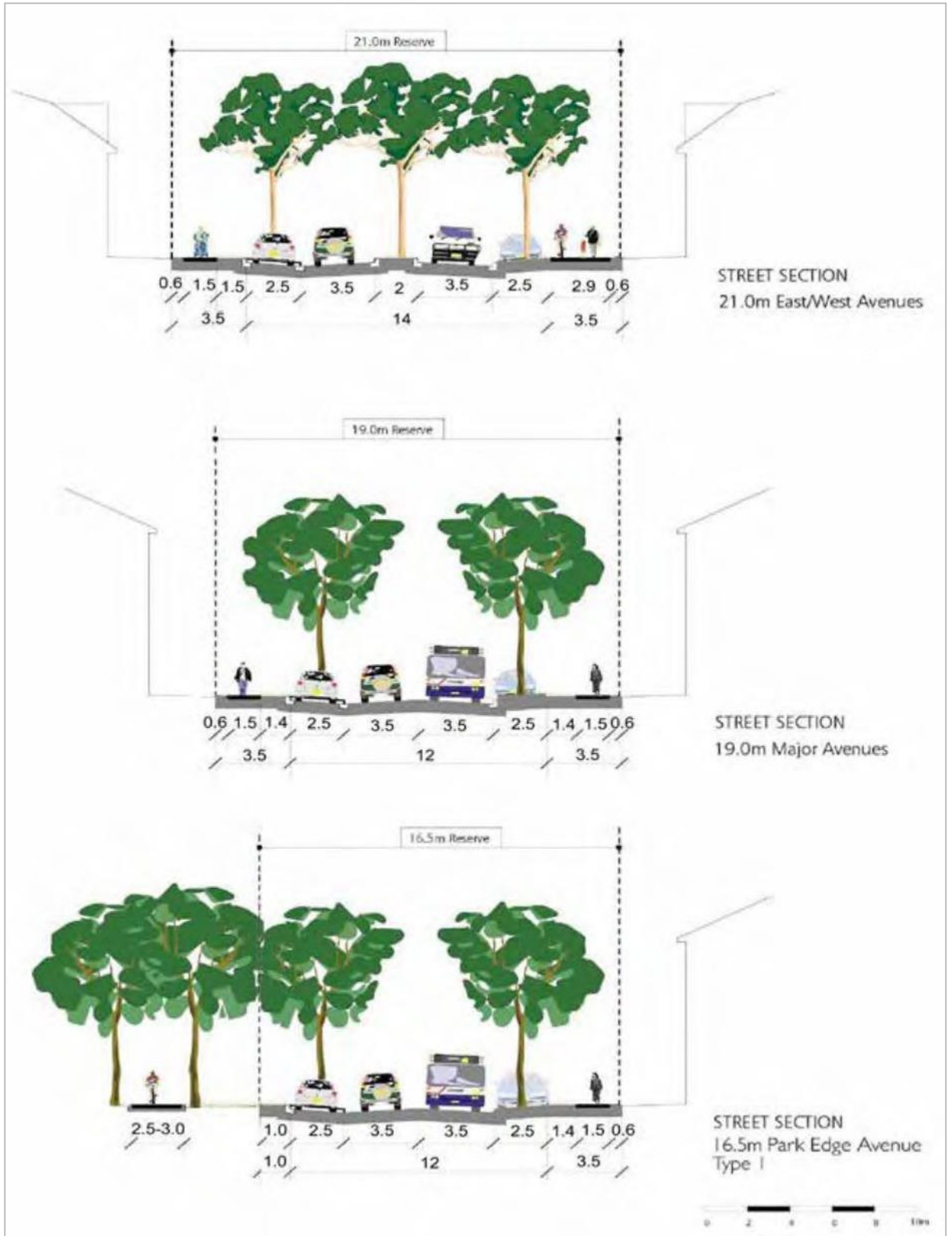

Figure 60: Street sections - Pemulwuy North



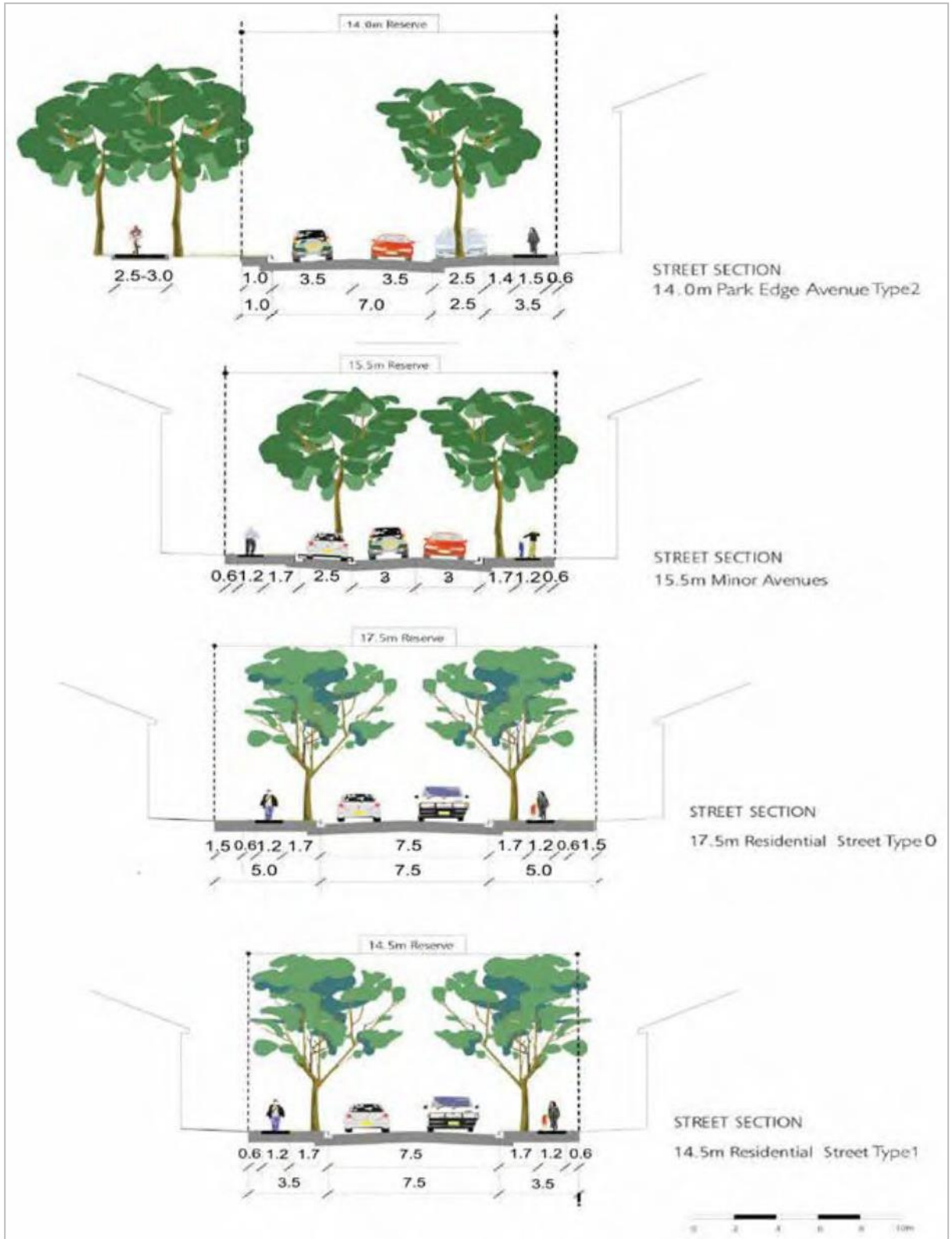

Figure 61: Street sections - Pemulwuy North

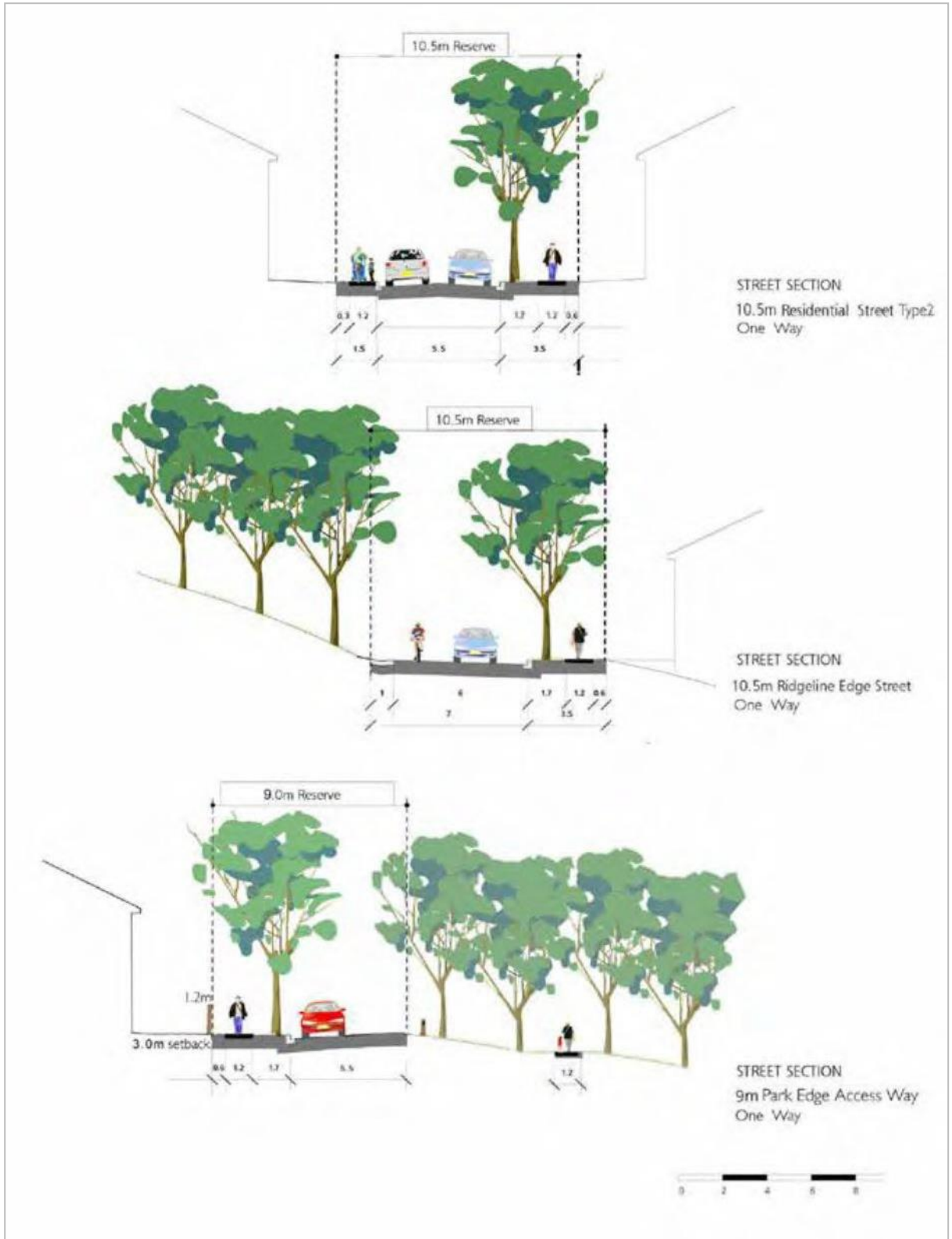

Figure 62: Street section - Pemulwuy North

### 3.6.6 Public Road Designs – Pemulwuy South

#### **Controls**

##### Distributor (East-West Link Road)

- indicative traffic volumes – 11,000 vehicles per day on completion and if open to all traffic;
- 24m road reserve;
- 2 lanes provided in each direction – (3.5m + 3.5m) x 2;
- potential to utilise clearway conditions during peak periods;
- no parking in carriageway from the intersection with Greystanes Road to the first roundabout.
- parking provision in carriageway during non-clearway periods (or indented) providing 2 through traffic lanes in each direction at peak times and one through lane in each direction at other times;
- 1.5m footpath width located on one side away from the kerb; and - designated 3m; and
- shared cycle/ pedestrian path provided.

##### Collector road (East-West and Major North-South Avenues)

- indicative traffic volume – 6,000 – 7,000 vehicles per day;
- 19 - 21m road reserve;
- one through traffic lane of 3.5m, provided in each direction;
- parking provision in carriageway or indented between street trees;
- 1.5m footpath width located both sides away from the kerb; and
- an additional 1.4m footpath for a cycle lane to be provided on the East- West Avenue.

##### Local streets (Minor North-South Avenues, Ridgeline Edge, Park Pair, Residential and Park Edge Streets)

- indicative traffic volume – 300 – 3,000 vehicles per day;
- 10 – 15.5m road reserve;
- 5.5 – 8.5m carriageway width;
- parallel parking provision in carriageway;
- Park Pair Streets one way access;
- 1.2m minimum footpath width on both sides excluding Ridgeline edge streets (one side only); and
- cyclists to share road with vehicles.

##### Local access street (Little Streets)

- indicative traffic volume – up to 300 vehicles per day;
- 10.5m road reserve;
- 5.5m carriageway width;
- one way access;
- no parking provision in carriageway;
- access to all sites;
- 1.2m footpath on both sides; and
- cyclists to share road with vehicles.

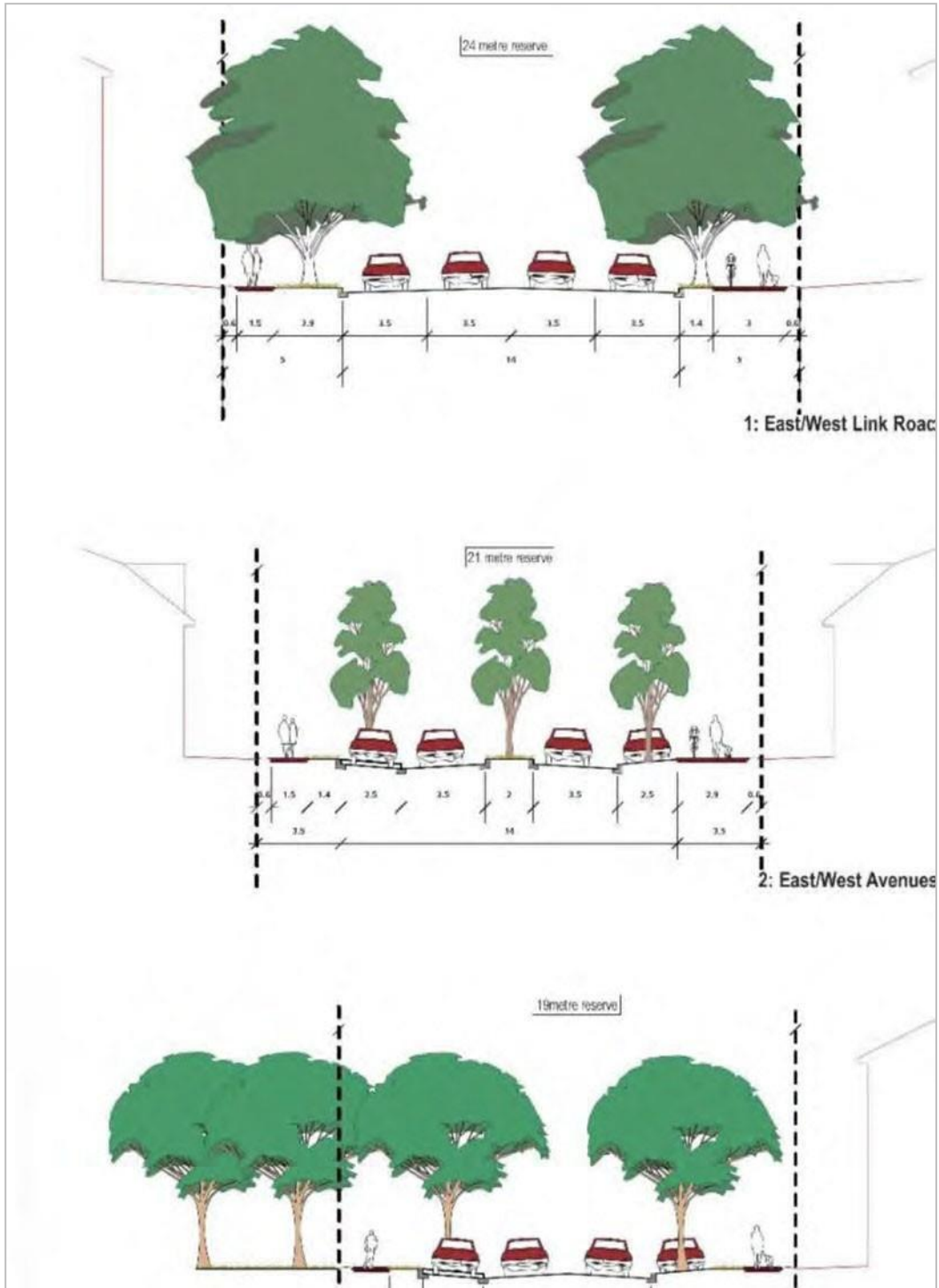

Figure 63: Distributor and collector roads - Pemulwuy South

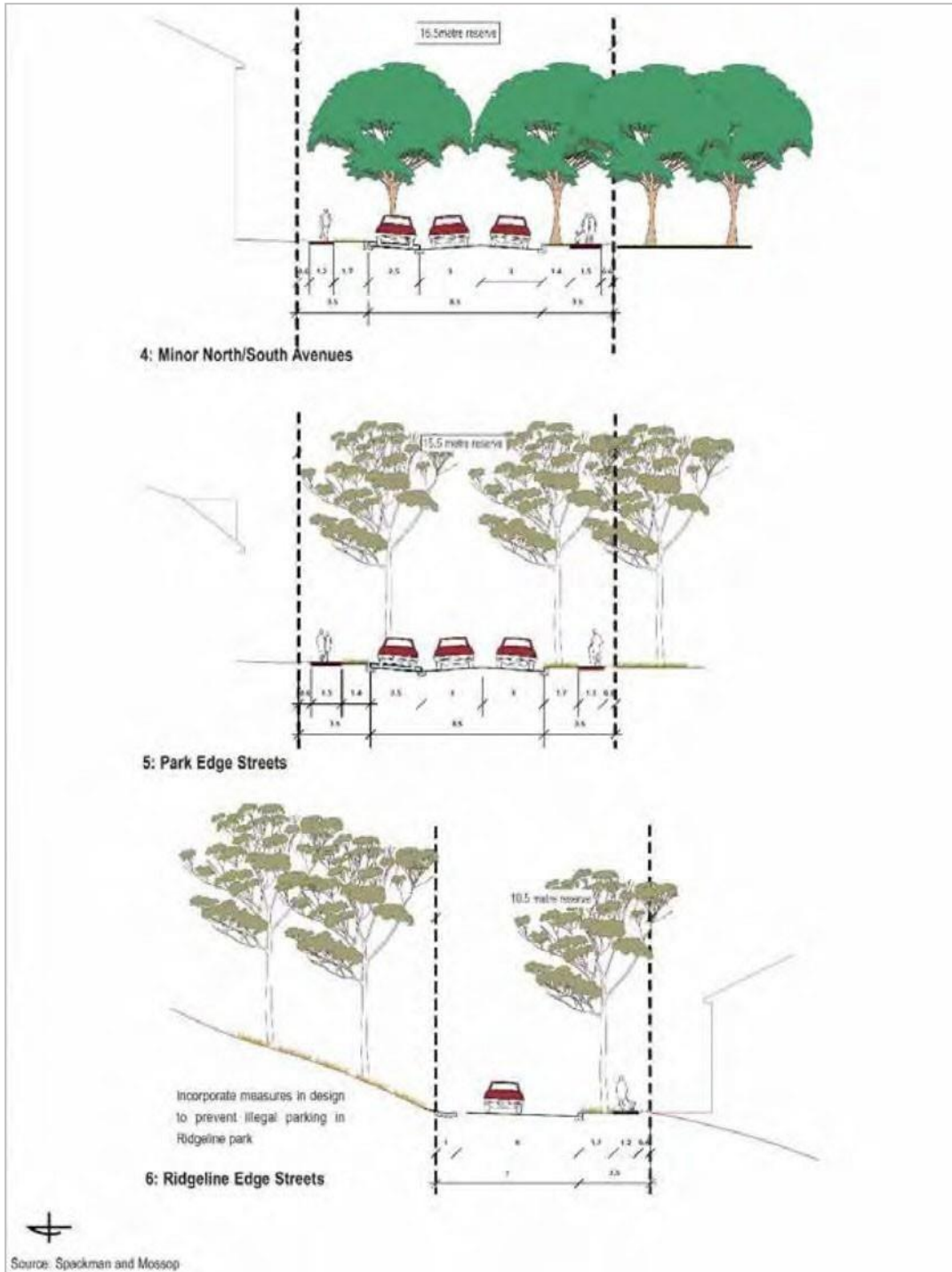

Figure 64: Minor north/south avenues - Pemulwuy South



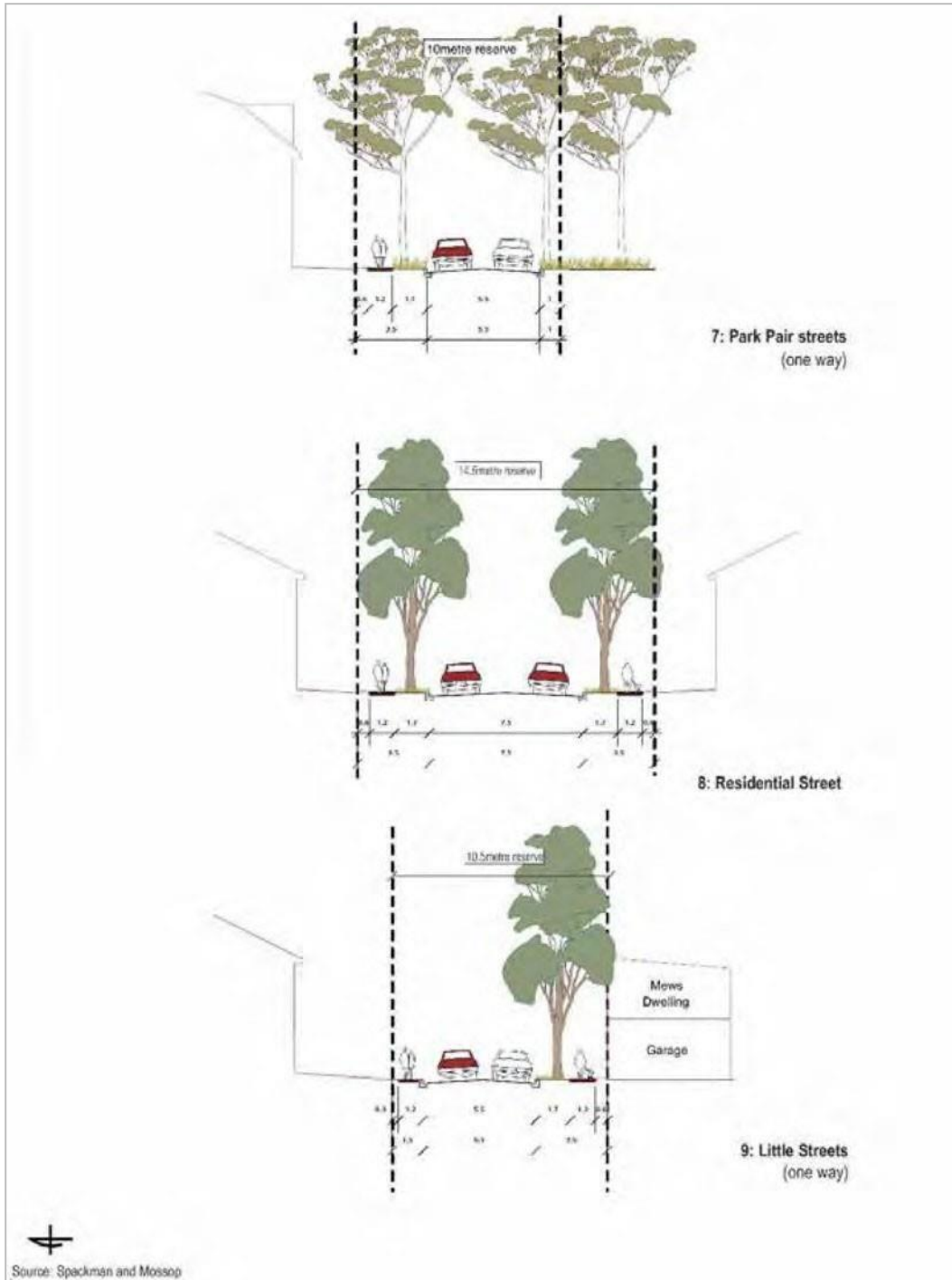

Figure 65: Park pair, residential and little streets - Pemulwuy South

### 3.6.7 Streets, Park Edges, Pedestrian Spines – Landscape Designs

Note: For Objectives for design of Street Landscape, Park Edges and Pedestrian Spines, refer to Section 3.6.6 above.

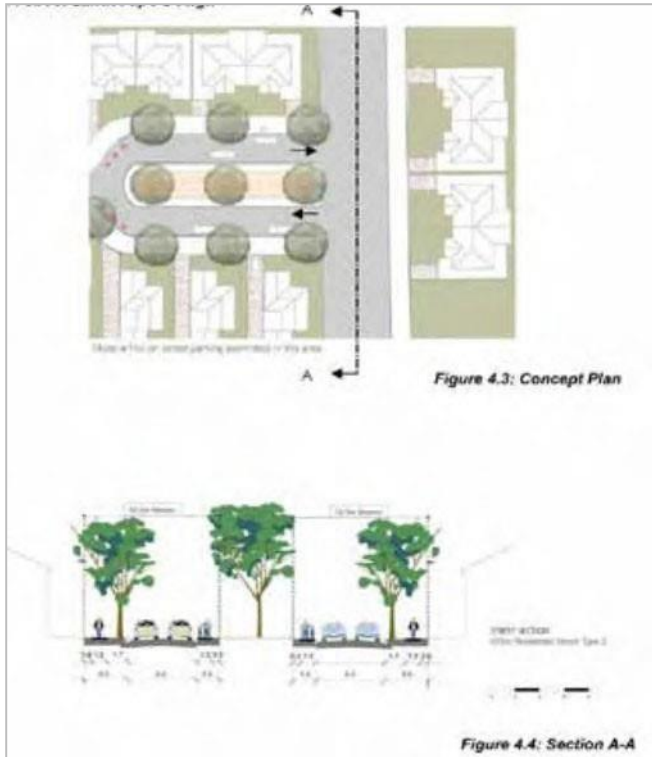

Figure 66: Streetscape design

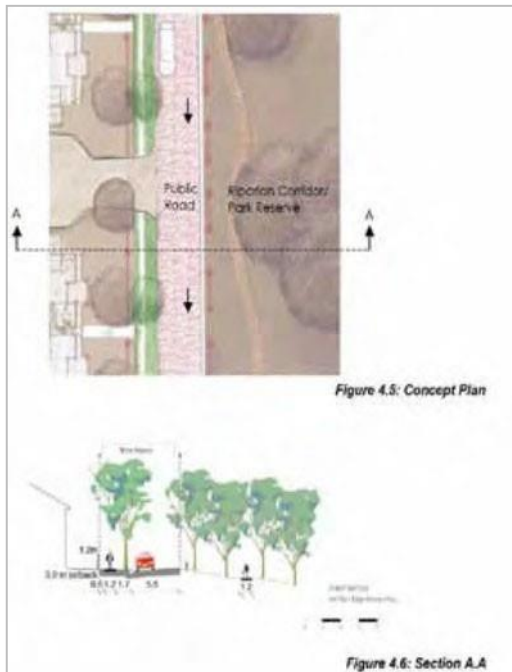

Figure 67: Park edge access ways

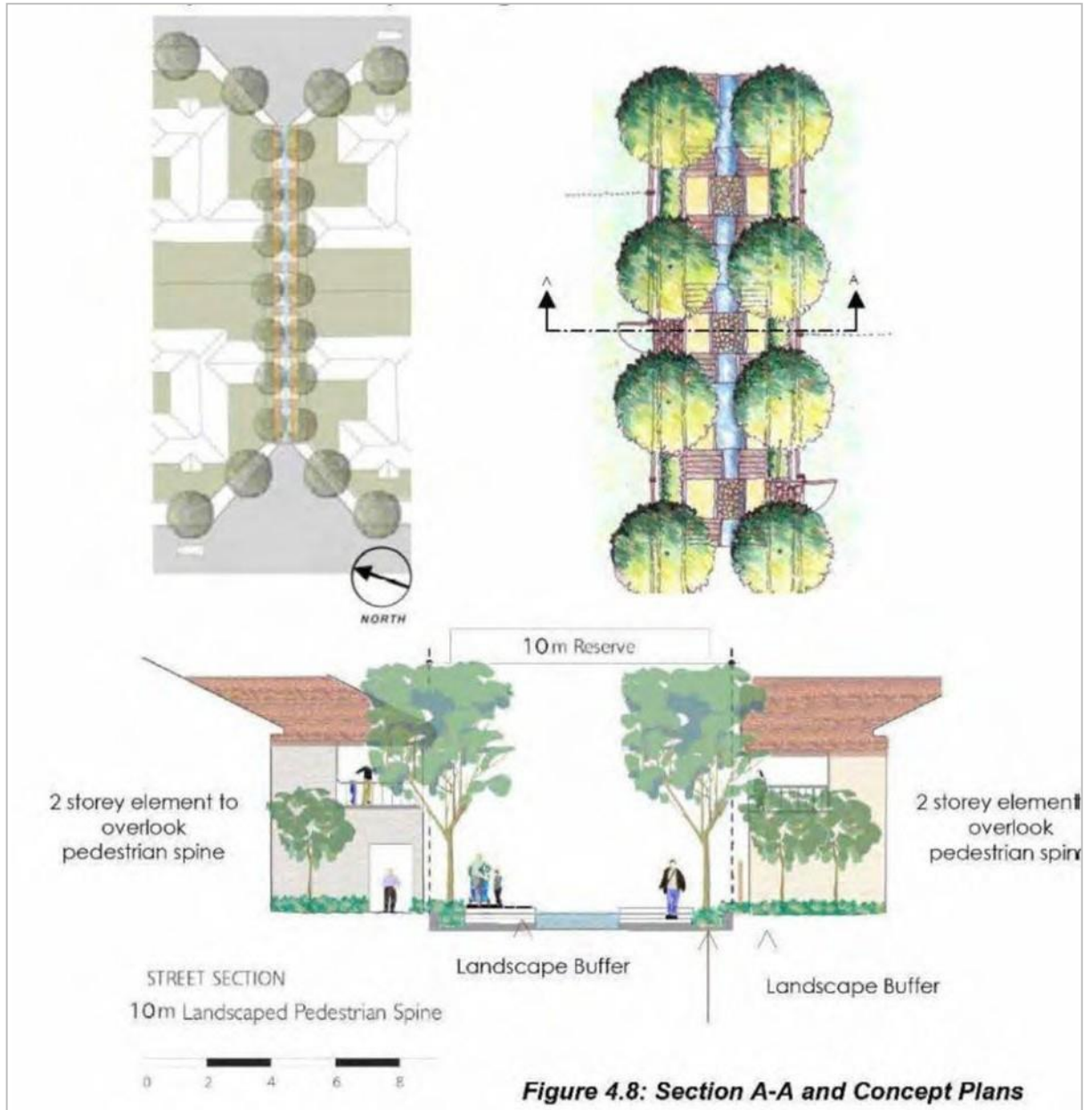

Figure 68: Landscaped pedestrian spine design

### 3.6.8 Public Transport

#### Objectives

- O1. Achieve a minimum 10% increase in non-private vehicle mode splits for the journey to work compared to a “conventional development” approach.
- O2. Provide a bus route through the site to link to local busways and the regional transport network.
- O3. Ensure that public transport stops, nodes and interchanges are safe, attractive and inviting to maximise their use.



- O4. Achieve reductions in VKT of at least 5% compared to 'conventional' residential development.

### **Controls**

- C1. Public transport access points are to be provided to maximise the proportion of residents who are located within 400m safe walk of a bus stop.
- C2. Bus routes should create links to Blacktown, Merrylands Station, and any proposed transitways.
- C3. Bus stops to be identified at 200m intervals with bus shelters to be provided at 400m intervals along designated bus routes.
- C4. In developing the residential land, construct and dedicate roads.

### Local Public Transport

- C5. Provide appropriate facilities at bus stop locations to encourage increased use and safety. Such facilities may include bus lay-bys, speed controls to protect pedestrians, shelters and seating for waiting passengers, display of timetable information and street lighting for security.
- C6. Make arrangements with bus operators to provide bus services as early as possible within the development in order to promote usage.
- C7. Continue to seek optimum timetabling links to any proposed transitways/ bus routes.
- C8. Provide link feeder services to surrounding local areas, i.e. Greystanes, to improve access, catchment size and hence service viability.
- C9. Implement 'Demand Management' by promoting alternative modes of travel to the private car. This could include distribution of information packs on bus services and cycle routes, free bus tickets, advertising of services and introduction of bus services to each stage of development as the latter is completed.
- C10. The site owner/developer is to provide welcome information to incorporate public transport information and timetabling, including links to any proposed transitway.
- C11. The alignment and geometry of roads that form bus routes need to allow for efficient and unimpeded movement of buses without facilitating high traffic speeds. Where potential traffic calming devices are installed along bus routes specific design requirements for bus access must be employed; and
- C12. Indicative performance guidelines for bus routes are as follows:
- Minimum geometric layout:
    - Radius: 12.5m;
  - Road grades:
    - Max. desired pavement crossfall: 3%;
    - Max. desired gradient: (within 50m of stations): 6%;
    - Absolute max. gradient: (within 50m of stations): 12%.

(Source: RMS and AUSTROADS)

### 3.6.9 Pedestrian and Cycle Routes

#### Objectives

- O1. Encourage trips to be undertaken by walking and cycling instead of private vehicle.
- O2. Promote connectivity throughout Pemulwuy.
- O3. Create a clearly defined pedestrian and cycleway network within and through Pemulwuy.
- O4. Make connections to regional cycle links and between major areas of proposed and existing open space and other recreational, community and employment land uses.
- O5. Ensure non-vehicular links provide a safe and secure environment, both in terms of road safety and personal security, which encourages walking and cycling.

#### Controls

- C1. Create pedestrian and cycle linkages between the residential precinct and areas of open space, recreational, community and employment land uses, broadly along the alignment shown on Council's Bike Plan.
- C2. Within the Greystanes Creek Woodland Park, locate pedestrian and cycle routes as far as practicable in the outer protection zone.
- C3. Continue a shared vehicle and cycle routes along the ridgeline edge street in Pemulwuy South.
- C4. Locate and design walking and cycling networks to:
  - provide direct routes between key trip origins and destinations;
  - minimise steep grades; and
  - be safe in terms of road safety and person security.

#### Pedestrian

- C5. Undertake detailed design of pedestrian control and protection facilities is to be undertaken in accordance with the relevant sections of the Australian Standards (AS1742) and council's *Work Specifications for Subdivision and Development*. This includes pedestrian crossings, signage, local area traffic management and disabled access.
- C6. Ensure pedestrian only footpaths have a minimum width of 1.2m (wider footpath may be required in areas of high pedestrian activity such as community facilities, shops and other activity centres) and a maximum grade of 15%, except where grades on Prospect Hill make this unachievable.
- C7. Due to difficult grades, provide only walking tracks up to Prospect Hill linking to strategically located lookout points. The design and location of this path/s is to be in accordance with the *Prospect Hill Conservation Management Plan*, *Heritage Landscape Plan* and *Heritage Interpretation Plan*.
- C8. For identified pedestrian spine connections from Prospect Hill to the Woodland Park (see Figure 60), provide a reserve of 10m, with appropriate landscaping. These connections are to be overlooked with 2 storey houses that address the pedestrian route, creating passive surveillance with windows, balconies, sit-outs, and the like. Design fencing to assist in the overlooking of this public domain area.

Cycleways

- C9. Design cycling routes within the road hierarchy to reflect the level of activity and function of the various roads such as dedicated cycleways on collector roads and shared access on local streets.
- C10. Link designated cycleway routes to the surrounding regional cycleway network. Cycle routes along open spaces are to be between 2.5 – 3m in width (where shared with pedestrians), and designated accordingly.
- C11. Dedicated cycle lanes are to be either line marked or separated from the road lanes.
- C12. Provide opportunities for the cycle network to link with the proposed regional cycle route, including that along Lower Prospect Canal Reserve.
- C13. Link the pedestrian/cycle route to the north under existing roads (M4, Great Western Highway) using existing culverts if possible. Consult Blacktown City Council in this regard.
- C14. Link pedestrian/cycle routes within the Greystanes Creek Woodland Park with those in Pemulwuy South.
- C15. Use cycle routes to link all amenities and areas of interest, including commercial/retail areas, play areas and viewpoints.
- C16. Ensure technical design requirements such as pavement design and intersection/crossing treatments are consistent with *AUSTROADS Guidelines (1998) Guide to Traffic Engineering Practice, Part 14, Bicycles*.
- C17. Distribute secure bike parking throughout the cycleway network and likely destination points. Parking facilities range from simple hitching rails to secure bike lockers. Key locations would be within the employment precinct, near public transport linkages, at the village centre, at the Village Green, at Prospect Hill Park, and at the eastern detention pond lookout.
- C18. Provide for cycle refuge facilities at cycleway access points with collector roads.

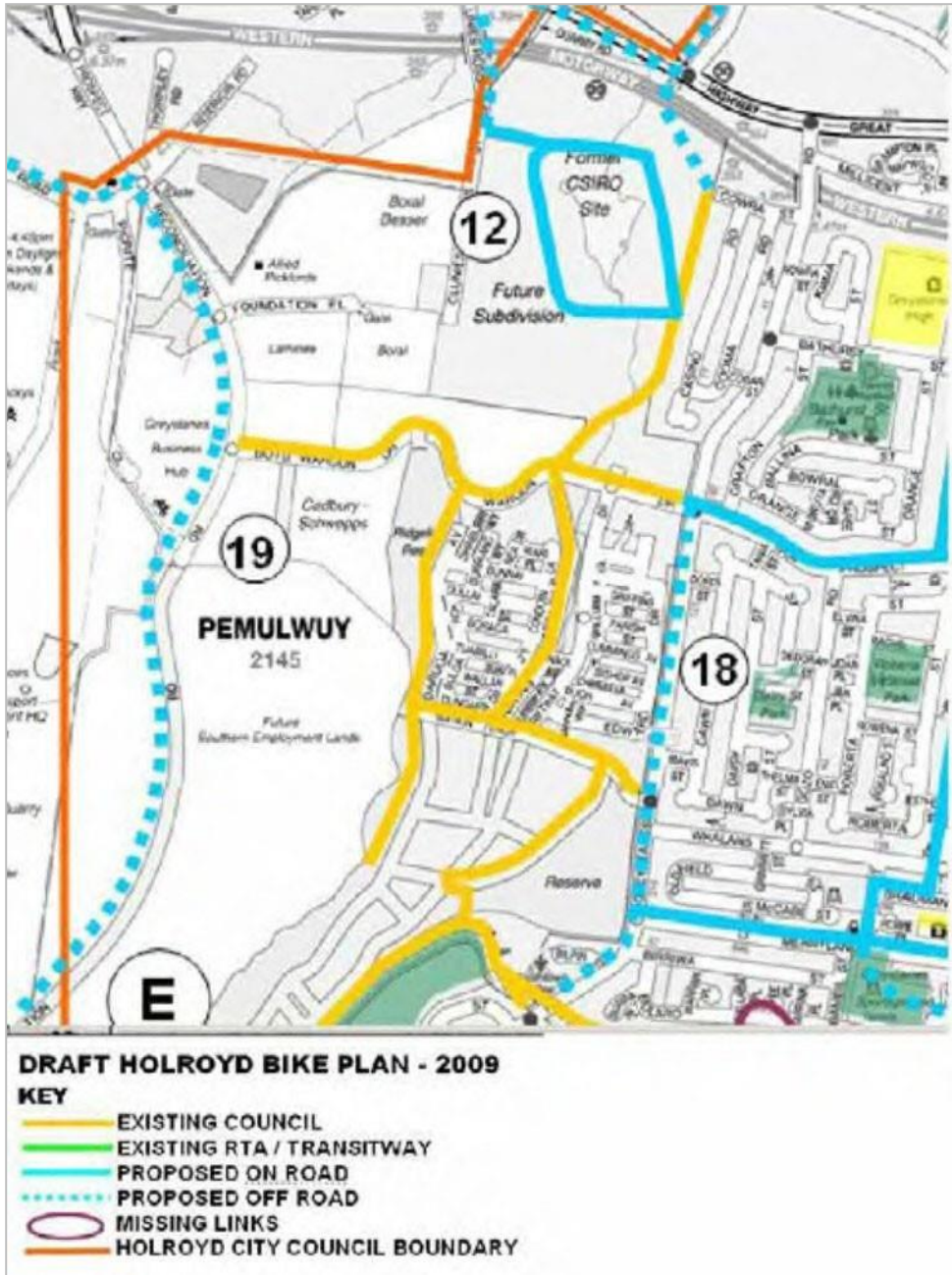

Figure 69: Bike Planning

### 3.6.10 Service Areas for the Village Centre (Pemulwuy South)

#### **Objectives**

- O1. Provide adequate access for service and delivery vehicles.

#### **Controls**

- C1. Ensure access and circulation design within development complies with Australian Standard AS 2890.
- C2. Allow service and delivery vehicles to efficiently and safely access the Village Centre.
- C3. Ensure loading dock and delivery areas are appropriately designed.



### 3.7 Heritage

#### 3.7.1 Aboriginal Archaeology and Heritage

To provide information that could be used for planning and impact assessment, detailed archaeological investigations have been completed for Pemulwuy. The sensitive nature of some of the findings means that the accompanying maps (Figure 70 and Figure 71) provide only a general indication of the vicinity of archaeological items. For further information, see the Biodiversity and Heritage Background Report (Pemulwuy South) and Aboriginal Heritage Reports by ERM, May 2004, March 2005 and Jo McDonald Cultural Heritage Management, August 2003; (Pemulwuy North).



Figure 70: Aboriginal sites sensitivity map - Pemulwuy North

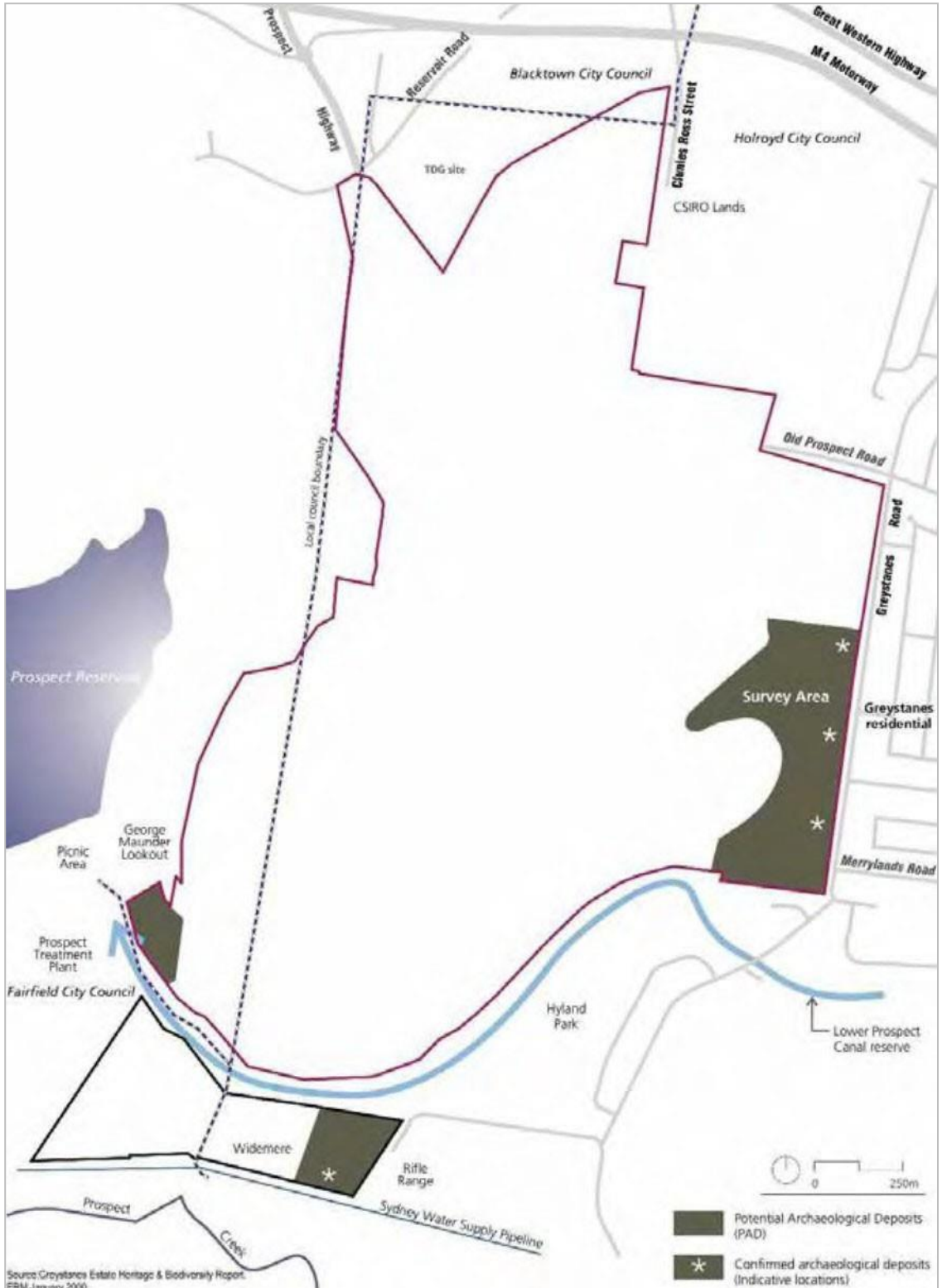

Figure 71: Archaeological and excavation sites - Pemulwuy South



### 3.7.2 Strategic Archaeological Management

The area is important to Aboriginal people, as Prospect Hill and the surrounding area is known to have been a significant meeting place. It also has historical significance for its association with conflict between local Aboriginal people and the first settlers at Prospect Hill. For further explanation, refer to the *Prospect Hill Conservation Management Plan*.

#### Objectives

- O1. Retain and preserve some representative areas of high potential for archaeological deposits (PAD).
- O2. Conserve representative Aboriginal artefacts, sites and sensitive areas (PADs) within open space, where possible.
- O3. Salvage information and artefacts from PAD sites that will be impacted by development.
- O4. Recreate and manage elements of the cultural landscape by rehabilitating a suitable area of woodland communities to resemble those that existed prior to European settlement. This would be undertaken in consultation with the local Aboriginal community.
- O5. Incorporate recognition of the Aboriginal and European heritage of the site into conservation management strategies.
- O6. Protect identified scarred trees.  
  
Determine the ownership and ongoing management responsibility of the surrounding open space areas.
- O7. Define the excavation program.
- O8. Record findings.
- O9. Obtain a Consent to Destroy.
- O10. Educate the local community in the pre-European history of the site.
- O11. Interpret the findings of the ERM archaeological excavations at CSIRO-4 and educate the local community on the pre-European history of the site.
- O12. Protect site locations, contextualised in the broader cultural landscape.
- O13. Reflect Aboriginal occupation and history in the public areas.
- O14. Conserve areas of high PAD and significant known artefacts or sites within Grey Box Reserve.
- O15. Manage the impacts from recreation and access.
- O16. Educate the local community in the pre-European history of the site.

### **Controls**

- C1. Create an area of open space with the primary function being conservation of ecological and archaeological resources.
- C2. Undertake investigations prior to destruction of known or potential sites for the purposes of salvage and contextual information.
- C3. Retain all potential scarred trees in open space that is accessible to the Aboriginal community.
- C4. Seek comment to destroy CSIRO-4 (PAD2) under section 90 of the *National Parks and Wildlife Act 1974*.
- C5. Develop a program to educate the local community on the pre-European history and heritage values of the Pemulwuy area.
- C6. Recreate and manage the cultural landscape in conjunction with the local aboriginal community by vegetating open space to resemble the natural landscape prior to European settlement. These strategies are outlined elsewhere.

### Scarred trees

#### **Controls**

- C7. Ensure scarred trees are located within open space (e.g.: on the western side of Greystanes Creek), surrounded by enhanced locally indigenous vegetation, yet that is accessible to the Aboriginal community.
- C8. Protect scarred trees and avoid drawing attention to them, place a screen using locally indigenous shrubs around the tree.
- C9. Place any developments such as playground structures, benches, barbecue facilities etc. away from the trees.
- C10. Dedicate the open space within which the tree is contained to Council prior to development of adjoining areas.
- C11. Consult the Aboriginal community in naming of these open space areas.
- C12. Involve representatives of the Aboriginal community in confirming and locating the tree prior to development commencing, and ensure that correct protection measures are in place.
- C13. Note the existence and protected status of the scarred tree in any bushfire management plan so that the tree is not impacted during any hazard reduction burning.

### Excavation for salvage and consent to destroy

Areas of PAD (Potential Archaeological Deposit) that are outside conservation areas will be developed. In order to obtain archaeological information about the site before it is destroyed, a salvage excavation program is required prior to development.

#### **Controls**

- C14. For the area outside any conservation area and outside the drip line of any scarred tree, prepare an application for section 90 Consent to Destroy from NPWS, with permit to

salvage/ collect any artefacts observed by the aboriginal community during monitoring of construction impacts.

- C15. In order to obtain archaeological information about the archaeologically sensitive areas, develop a detailed salvage excavation program for selected areas outside any conservation area shown in Figures 70 and 71 and 72 (E.g.: PADs 1 to 4).
- C16. Prepare a detailed report that outlines the method and results of excavation. In the report discuss the results in light of all surface survey results and excavation results within Pemulwuy.
- C17. Provide a copy of the report to the NPWS, Cumberland City Council, the Deerubbin Aboriginal Land Council, Darug Tribal Corporation, Darug Custodian Aboriginal Corporation, and Gandangara Local Aboriginal Land Council.
- C18. Prepare a Plan of Management to ensure the ongoing protection of Indigenous cultural heritage that will be preserved within open space across Pemulwuy. Include within the Plan the scarred tree and any PAD within the open spaces, and incorporate relevant natural areas to achieve protection of a holistic cultural landscape. Involve the Aboriginal community in the preparation of the Plan of Management.
- C19. Monitor ground clearing during the initial construction phase through the Aboriginal community under a Section 80 Permit in the event that archaeological material is encountered.
- C20. If archaeological material is observed during or after clearing, cease work immediately, consult the Aboriginal community, and seek advice from NPWS. The Aboriginal community will collect this material. This work should be covered by the Section 87 Permit and should not impact on the construction schedule.
- C21. Should human skeletal remains be encountered, then work must cease immediately and advice sought from NPWS and the Aboriginal community. The section 90 consent would not cover this type of evidence.
- C22. Use information obtained from salvage excavation in conjunction with the existing ERM test excavation results when developing an Aboriginal heritage education program including signage for any conservation area and other open space locations.

#### Aboriginal Heritage management measures

#### **Controls**

- C23. Do not make site locations and descriptions publicly available.
- C24. Provide general knowledge of Aboriginal sites and their legal protection to developers and general maintenance staff. The proponent should make clear to construction crews/ subcontractors, the specific responsibilities regarding the protection of Indigenous cultural heritage items (e.g.: CSIRO-1), to ensure that inadvertent damage or destruction does not occur in those areas to be preserved.
- C25. Prepare an education strategy for cultural heritage awareness for developers, contractors and Council. Include a fact sheet and sensitivity map indicating areas requiring particular attention and consultation with the Aboriginal community and NPWS.
- C26. Invite the Aboriginal community to actively participate in developing the education strategy.

- C27. Consult the Aboriginal community prior to and during clearing and preliminary ground work to collect artefacts from areas to be developed.
- C28. Do not erect signs which draw attention to the identified archaeological sites. This will prevent disturbance to Aboriginal and archaeological sites.
- C29. In the naming of parklands and reserves, incorporate recognition of Aboriginal occupation and the history of the area. Consult the Aboriginal community in the naming of these features.
- C30. Consult the Aboriginal community regarding an appropriate memorial under management measures.
- C31. Consult the Aboriginal community on the development of any walking routes or areas within the precinct which incorporate descriptive signs and interpretation along these.
- C32. Consult the Aboriginal community regarding the design of landscaping of waterways and parklands in the precinct as well as re-vegetation programs.

#### Grey Box Reserve Aboriginal Heritage management

##### **Controls**

- C33. Preserve Grey Box Reserve, Pemulwuy, incorporating areas of potential archaeological deposits and representative elements of the cultural landscape.
- C34. In particular, preserve the core conservation area in the south eastern corner of the site.
- C35. Prepare a plan of management for Grey Box Reserve, detailing measures to appropriately manage the Aboriginal cultural heritage. This should be prepared in consultation with the local Aboriginal community, the National Parks and Wildlife Service (NPWS) and Council.
- C36. Limit recreational opportunities in the conservation area to passive activities.
- C37. Develop a suitable educational program in consultation with the local Aboriginal community, National Parks and Wildlife Service and Council.
- C38. Ensure that interpretive signs and other educational material are general in nature and do not draw attention to any physical aspects of the Aboriginal cultural heritage.

### 3.7.3 European Heritage

#### **Objectives**

- O1. Protect the integrity of the crown of Prospect Hill and other sites identified as being of European heritage significance.
- O2. Research and document the history of the site of Pemulwuy and its role in the history of Sydney.
- O3. Educate the community on the history and role of the site.
- O4. Utilise the history of the site as a theme in its redevelopment.
- O5. Preserve the original gates of Greystanes House as an integrated part of the development.

**Controls**

- C1. Record Pemulwuy as a whole in its current state photographically, utilising aerial photography and possibly digital video recording.
- C2. All documentary, cartographic and photographic material related to the development, growth, buildings and history of the site should be sourced, accessioned and archived. Collect copies of accessible historic material into an archive which must be lodged in the care of an organisation which is acceptable to Council and where it is available for research and educational purposes. Identify archive material held elsewhere and cross-reference it with the above archive. A written description of major structures should accompany the photographic record.
- C3. Incorporate the Greystanes House gates into the development at an appropriate location and keep them in a satisfactory condition.

## 3.7.4 Prospect Hill State Heritage Registered Area

**Objectives**

- O1. Protect the integrity of the *Prospect Hill State Heritage Registered Area*.
- O2. Research and document the history of the *Prospect Hill State Heritage Registered Area* and its role in the history of Sydney.
- O3. Educate the community on the history and role of the site.
- O4. Utilise the history of the site as a theme in its redevelopment.

**Controls**

- C1. Maintain the prominence of Prospect Hill as a significant remnant geologic and topographic element. Site and design development at critical locations so that views of the ridgeline are maintained.
- C2. Ensure that future use, landscape interventions, heritage interpretation and vegetation management of the *Prospect Hill SHRA* are informed by and consistent with:
  - *Prospect Hill Conservation Management Plan* (Conybeare Morrison: 2005);
  - *Prospect Hill Heritage Landscape Study and Plan* (Government Architect's Office: 2008); and
  - *Prospect Hill Heritage Interpretation Plan* (MUSEscape: 2009).
- C3. Development within the vicinity of the *Prospect Hill State Heritage Register Area* may require a Heritage Impact Assessment to accompany Development Applications. The Heritage Assessment shall be in accordance with the three documents listed above under C2. The need for a heritage assessment is at the discretion of Council.
- C4. In the instance where a broad Heritage Assessment of the interface between the Prospect Hill State Heritage Register Area and the adjoining sites has been undertaken, submit with all Development Applications a Statement of Environmental Effects addressing this Heritage Assessment.

**3.8 Biodiversity**

Although Cumberland Plain Woodland occurs on site, these remnants are mostly small and in relatively poor condition. Despite this, the endangered status of the woodland has been recognised by the formulation of objectives. A high proportion of the woodland will be conserved

and added to by regeneration. The ecological objectives of the site have been developed in recognition of the fact that the site has been extensively cleared, and have been devised to allow for retention and enhancement of the existing patches of native vegetation and, where possible, improving linkages between them.

**Objectives**

- O1. Maintain the existing level of biodiversity during and after development.
- O2. Conserve significant vegetation communities that are locally indigenous to Pemulwuy.
- O3. Conserve threatened species populations and their habitats.
- O4. Retain and enhance the riparian corridor.
- O5. Create fauna movement corridors within the site and link to external ecological resources (where practicable allowing for other site uses).
- O6. Balance the ecological values of the site with other development requirements.

**Controls**

- C1. Create areas of public open space with the incorporation of conservation, ecological and archaeological resources.
- C2. Provide an open space network which will have multiple functions, including increasing areas of native vegetation and providing fauna movement corridors.
- C3. Plant and manage the site to minimise hazards and manage impacts from bushfire.
- C4. Conserve remnant communities of Cumberland Plain Woodland and Sydney Coastal River Flat Forest.

3.8.1 Ecologically Sustainable Development

**Objectives**

- O1. Abide by the precautionary principle.
- O2. Promote social equity, including inter/generational equity.
- O3. Conserve biological diversity and ecological integrity; and
- O4. Improve valuation and pricing of environmental resources.

**Controls**

- C1. Undertake adequate studies and analysis of the natural heritage of a site to determine an appropriate course of action having regard to the available information.
- C2. Maximise use of renewable energy sources e.g. energy and service efficient subdivision layout; and minimise materials consumption e.g. recycling and re-use of materials in the enhancement and formation of on-site landforms.
- C3. Practise water efficiency and conservation measures to reduce water consumption, the use of solar energy for heating appliances, and maintenance or improvement of water quality through a catchment management approach to the site.

- C4. Maintain and enhance significant vegetation and habitat.
- C5. Minimise the use of non-native flora, and protect threatened ecological communities e.g. provide compensatory and additional habitat in appropriate areas for vegetation corridors, by tree propagation and planting native species within existing and proposed vegetation corridors.
- C6. Recognise and integrate significant cultural and archaeological features/aspects into designs.
- C7. Ensure that the Cumberland Plain Woodland/Sydney Coastal River Flat Forest along the Creek, containing several mature species typical of the area, is largely conserved and managed to enhance the ecological value of the site.

### 3.8.2 Fauna Movement Corridors

#### **Objectives**

- O1. Provide vegetation which will facilitate movement through the site of non-ground dwelling fauna.
- O2. Provide additional foraging habitat.
- O3. Provide connectivity with off-site linkages for main corridors to and from external ecological resources.

#### **Controls**

- C1. Use locally indigenous species in vegetating the corridor network including threatened and regionally significant species. Plantings should be propagated from locally collected seed and be hardened on site.
- C2. Retain existing canopy species typical of Cumberland Plain Woodland and Sydney Coastal River Flat Forest where possible throughout the site.
- C3. Provide a vegetated riparian corridor (consisting of a core riparian zone and outer protection zone) along either side of Greystanes Creek to protect water quality, aquatic habitat and allow for fauna movement, plus some passive recreational and aesthetic functions. Refer to Figures 72 and 73 below.
- C4. Ridgeline and creekline corridors should have a minimum width of 20m.
- C5. Extend the riparian corridor the entire length of Pemulwuy and provide additional opportunities to link westward to Cumberland Plain Woodland around Prospect Reservoir.
- C6. Extend the riparian corridor along the eastern side of the detention pond as the primary corridor.
- C7. Utility services and recreation uses may be located within the corridor provided they are sited and designed recognising the ecological function of the corridor.
- C8. Facilitate fauna movement through the vegetation in the parks street trees and Grey Box Reserve.
- C9. Provide details in development applications which demonstrate how connectivity with these off-site linkages can be achieved.



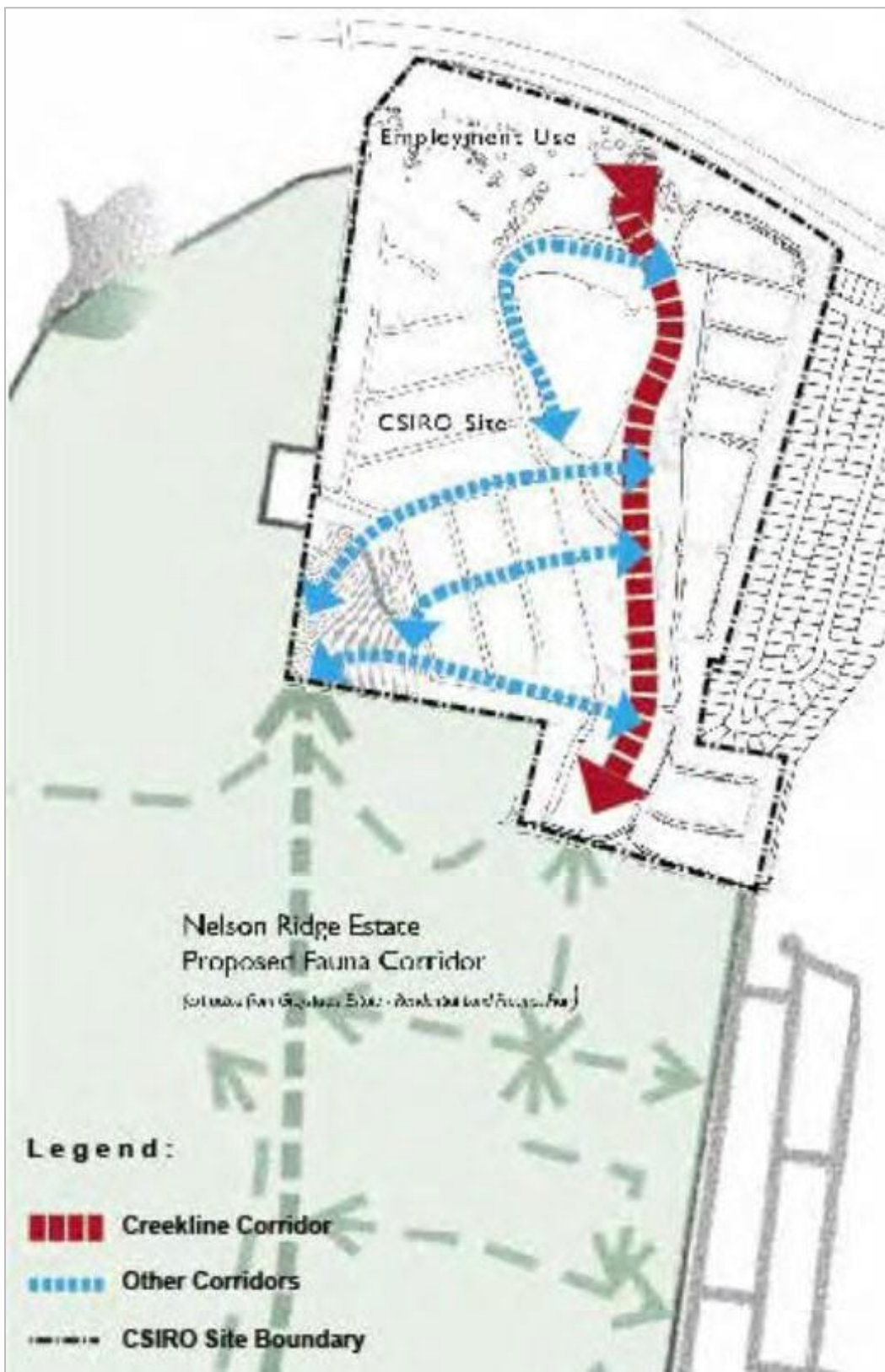

Figure 72: Flora and fauna corridors - Pemulwuy North



Figure 73: Flora and fauna corridors - Pemulwuy South

### 3.8.3 Development Areas

#### Objectives

- O1. Enhance and maintain biodiversity by complementing other conservation initiatives.
- O2. Use locally indigenous plant species, including threatened and regionally significant species, in drainage areas, streetscapes and open spaces.
- O3. Reduce water and fertiliser demand.
- O4. Reduce salinity effects on the site, buildings and infrastructure.

### **Controls**

- C1. Manage any development proposal to provide opportunities to enhance and maintain biodiversity by complementing other conservation initiatives.
- C2. Use locally indigenous plant species, including threatened and regionally significant species in drainage areas, streetscapes and open spaces. (Use of local native species will not only enhance biodiversity but will reduce water and fertiliser demand, resulting in decreased water and nutrient volumes draining from the site).

### 3.8.4 Biodiversity Management Measures

#### **Objectives**

- O1. Rehabilitate and regenerate native vegetation.
- O2. Protect threatened species.
- O3. Manage weeds.
- O4. Minimise impacts from access to the conservation areas.
- O5. Minimise hazards and manage impacts from fire.
- O6. Minimise litter and waste.
- O7. Control and minimise impacts from sediment disturbance and erosion.
- O8. Replace the pine plantation.
- O9. Manage feral and domestic animals to minimise impacts on native flora and fauna.
- O10. Protect water quality and aquatic habitat.
- O11. Protect significant trees.
- O12. Involve the community.

#### **Controls**

- C1. Design any conservation area to optimise edge-to-area ratios and to incorporate areas of greatest biodiversity. The conservation areas include the Greystanes Creek riparian corridor, Prospect Hill ridgeline, Grey Box Reserve and other areas identified as bushland.
- C2. Prepare a bushland management plan prior to any development which identifies areas to be revegetated, the species to be used and other detailed management issues.
- C3. Regenerate the understorey in conservation areas to increase overall viability and robustness.
- C4. Collect and propagate seeds of locally indigenous species as part of such development. These are to be used in revegetating the open space corridors, including the riparian corridor and ridgeline.

- C5. Prefer native grasses in service/open space areas rather than kikuyu, couch or other conventional non-native grasses. (“Sir Walter” Buffalo grass is a non-native turf species unsuited to these bushland areas).

#### Threatened Species

- C6. Consult with NPWS and specialists in threatened flora to determine specific management measures for *Pimelea spicata* (a low spreading shrub that is listed as an endangered species) prior to any development within Pemulwuy South.
- C7. Prior to development of the residential lands south of Watkin Tench Parade, a recovery plan for *Pimelea spicata* should be prepared which takes into account the population in Pemulwuy and connectivity with the population found along the Lower Prospect Canal Reserve.
- C8. Retain and enhance continuous canopy in the conservation area and open space corridors to allow for possible squirrel glider movement onto the site.
- C9. Retain and enhance foraging habitat (Cumberland Plain Woodland) as appropriate within conservation areas to provide for Greater Broad-nosed Bat, Eastern Freetail Bat and Eastern Falsistrelle.
- C10. Elsewhere, where there is minimal potential conflict with urban development, retain significant mature trees with high ecological value as habitats for the Powerful Owl, Greater Broad-nosed Bat, Eastern Falsistrelle, Eastern Freetail Bat and the Masked Owl.

#### Weeds

- C11. Remove all weeds from conservation areas.
- C12. Ensure that weed control is an integral part of maintaining and enhancing biodiversity of the conservation areas and corridors.
- C13. In any bushland management plan, address weed management and removal methods such as hand weeding, spraying etc. The plan is to give attention to the conservation and corridor areas.
- C14. Replant cleared areas with locally indigenous plants following weed removal, to minimise soil erosion.
- C15. Outline a priority listing of target and noxious weeds in any bushland management plan, including Lantana, African Olive, Smallleaved Privet and Large-leaved Privet.
- C16. Ensure that houses have outlooks to the bushland to encourage residents to take ownership of the bush and minimise dumping of rubbish and garden clippings. Houses should not immediately abut conservation areas (ie be separated by road or some other divider).

#### Access to the conservation areas

- C17. Minimise access to conservation areas to allow the sites to regenerate with minimal human contact.
- C18. Domestic animals are prohibited in the conservation areas.

Fire

- C19. Prepare a fire management plan for the protection of life and property. The fire management plan should identify suitable fire regimes for the protection and maintenance of biodiversity.
- C20. Ensure that fire management elements are incorporated into the design of the conservation areas and through the central ridgeline ie fire trails.
- C21. Identify appropriate fire management regimes for vegetation management.

Litter and waste

- C22. Provide adequate signs and rubbish bins to encourage proper disposal of litter.
- C23. Secure rubbish bins sufficiently to prevent feral cats, dogs, rats and other undesirable species from opening them.
- C24. Maintain and empty bins on a regular basis to prevent waste accumulating.
- C25. Undertake regular patrols of conservation areas and report rubbish dumping.

Sediment disturbance and erosion

- C26. Implement appropriate sediment and erosion controls as per Part G of this DCP.
- C27. Commence planting and/or install fencing as soon as possible following weed removal to minimise erosion.
- C28. Prepare a sediment and erosion control plan for each subdivision stage. It should address the conservation areas, open space corridors and creekline where applicable.

The pine plantation

- C29. Remove the majority of pine trees from Pemulwuy, although some pine trees may be retained for street tree planting.
- C30. A program for the removal of the pine trees is to occur on a staged basis.

Feral and domestic animals

- C31. Prepare a feral and domestic animal management plan for Pemulwuy north and Pemulwuy South.
- C32. Implement an education program for residents on responsible pet ownership.

Water quality and aquatic habitat

- C33. Rehabilitate, enhance and re-establish the waterways of Pemulwuy, including creeklines and drainage lines.
- C34. Provide an appropriate vegetated riparian corridor either side of Greystanes Creek. Vegetation within the buffer should be rehabilitated and weeds removed.
- C35. Enhance vegetation using locally indigenous species of trees, shrubs, grasses and groundcovers.

- C36. Preserve indigenous vegetation in riparian corridors.
- C37. Install appropriate pollution controls such as gross pollutant traps in upper catchments (at site boundary if necessary) to prevent ingress of litter.

Significant trees

- C38. Where existing trees are healthy, sound and can reasonably be incorporated into the design, Council will normally require them to be retained. Council will consider concessions to the development control standards contained within this DCP in order to encourage the retention of existing mature trees. This should be discussed with officers prior to proceeding too far with your plans.
- C39. An application to remove a tree may be refused by Council if the tree:
- form(s) a prominent part of the streetscape;
  - stands alone and is thus of more significant than if it were part of a group of trees;
  - is of historic or cultural significance or is/are registered on any Council register of significant trees;
  - is prominent due to its height, size, position or age;
  - is a locally indigenous, rare or endangered species;
  - provides a significant visual screen;
  - is part of an important habitat for wildlife;
  - is part of remnant or riparian vegetation;
  - can be effectively treated by applying appropriate remedial treatment such as pruning of branches, pruning of roots and removal of deadwood or by other appropriate action as recommended by an arborist; and
  - is listed under the provisions of the *Threatened Species Conservation Act 1995*. (Listed as a threatened species, is habitat to a threatened species or is part of an endangered ecological community).

*Note: Council may refuse an application to remove a tree(s) but may give conditional consent for the appropriate remedial “branch or root pruning” for that tree(s).*

- C40. Retain and maintain hollow-bearing trees on site for their fauna habitat value wherever possible.

Community involvement

- C41. Prepare a community consultation strategy to involve the community in ongoing biodiversity management, including preparation of the bushland management plan.
- C42. Develop an educational program highlighting the significance of the site and how the community can be involved in restoring and maintaining the open space corridor.
- C43. Ensure that the Aboriginal community is consulted in reserve design, re-vegetation and interpretation programs.
- C44. Involve the community in weed removal and replanting programs and continue to involve the community in maintenance to instil a sense of ownership.



### 3.9 Stormwater and Flooding Management

#### 3.9.1 The Catchments

Pemulwuy can be divided into two main catchments. These are:

- Catchment A = all of the area of Pemulwuy North (north of Butu Wargun) plus the “Northern Residential Lands” of Pemulwuy South that are north approximately of Bobbina Avenue / Morley Avenue, all of which drains northward to the central former CSIRO Basin in Pemulwuy North via Greystanes Creek; and
- Catchment B = that part of Pemulwuy South approximately south of Bobbina Avenue / Morley Avenue, which drains southwards to Prospect Creek, partially called the “Southern Residential Lands”.

This is shown indicatively in Figure 74 and in Figure 75 below.

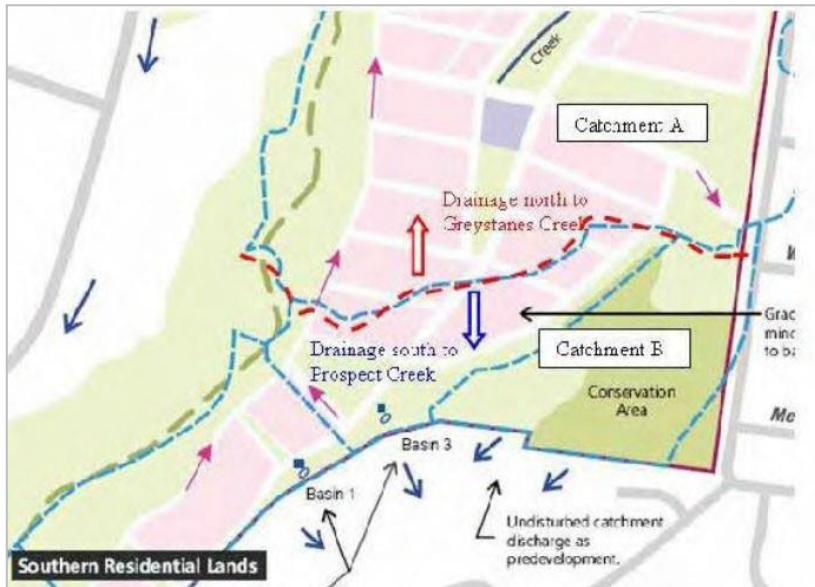

Figure 74: Boundary Catchment A (Greystanes Creek) and Catchment B (Prospect Creek)



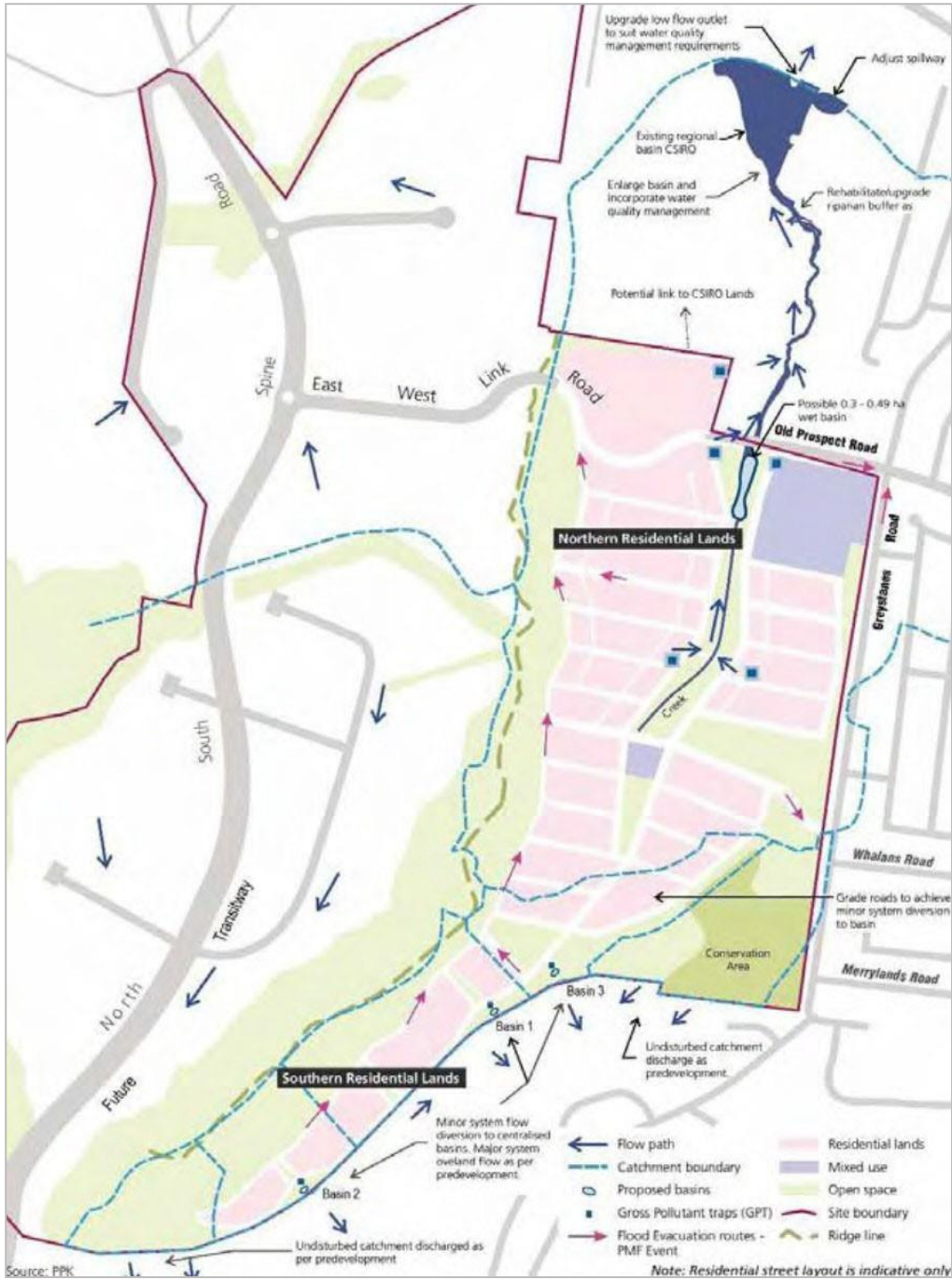

Figure 75: Prospect drainage strategy

### 3.9.2 Stormwater Management during Construction

#### **Objectives**

- O1. Prevent sediment polluting creeks.

#### **Controls**

- C1. Ensure that sediment control measures are in accordance with the requirements of the Managing Urban Stormwater Guidelines and with the *Managing Urban Stormwater: Soils and Construction* published by the NSW Department of Housing or its equivalent.
- C2. Stage development activities to minimise land disturbance.
- C3. Limit earthworks and disturbance of stable rehabilitated landforms.
- C4. Divert clean run-off from upstream areas around disturbed areas.
- C5. Stabilise and vegetate areas immediately following the completion of works.
- C6. Provide temporary sediment basins, fences, catch drains, check dams and other structures to collect and treat run-off from disturbed areas.
- C7. Monitor discharges from sediment basins and implement flocculation as required to limit TSS concentrations in water discharged from the temporary basins to 50 mg/L.
- C8. Provide vegetated buffer strips around all water bodies and drainage channels.
- C9. Temporarily stabilise stockpiles and disturbed areas.
- C10. Restrict vehicle access to designated entry and exits.
- C11. Provide stabilised site access.

### 3.9.3 Stormwater Management after Development

#### **Objectives**

- O1. Provide a development consistent with the principles of total watercycle management but recognising potential salinity problems.
- O2. Limit stream velocities to prevent erosion and scour of local waterways.
- O3. Reduce pollutant loadings to maintain downstream water quality.
- O4. Prevent the contamination of surface water or groundwater by stormwater run-off.
- O5. Ensure reduced demand for imported mains water by water conservation measures and re-use of stormwater in accordance with the principles of Water Sensitive Urban Design.
- O6. Protect and enhance the environmental and scenic value of the creek corridors.
- O7. Ensure that additional stormwater runoff generated by the development does not adversely affect peak flows, velocities and water levels downstream of the site in the full range of flood up to 1 in 100 year storm event.

## Controls

*Note: The water treatment objectives for Prospect Creek and the Upper Parramatta River catchments are listed in Tables 1 and 2 respectively. The objectives outlined in these tables are consistent with Council's Stormwater Management Plans.*

- C1. Ensure stormwater management systems are incorporated in the initial stages of design and infrastructure provided prior to the development of individual sites.
- C2. Design stormwater management measures to the water quality objectives of:
  - the Stormwater Management Plan;
  - the flow requirements of the UPRCT;
  - Cumberland City Council; and
  - Fairfield City Council.
- C3. Where feasible, incorporate in the proposed stormwater management measures, natural treatment mechanisms and features.
- C4. Integrate public open space with the trunk stormwater drainage corridors.
- C5. Where practical, reuse stormwater collected on developed lots. This can include rainwater tanks.
- C6. Carry out further Stormwater Management consultation with authorities during the development application stage.
- C7. As part of the development process, undertake detailed hydrologic, hydraulic and water quality modelling.
- C8. Use the results of the monitoring program required by the section of this plan below dealing with salinity, to inform surface water management practices as required.

*Table 2a: Pollutant Retention Criteria for Prospect Creek Catchment*

Pollutant	Treatment Options
Suspended Solids	80% retention of the average annual load
Total Phosphorus	45% retention of the average annual load
Total Nitrogen	45% retention of the average annual load
Litter	Retention of litter greater than 50mm for flows up to 25% of the 1 year ARI peak flow
Coarse Sediment	Retention of sediment coarser than 0.125mm for flows up to the 1 in 1 year ARI peak flow. Discharge free of settleable matter for all storm events less than or equal to the capacity of the water quality control ponds.
Oil and Grease	No visible discharge
Unnatural discolouration	No visible discharge

*Source: Prospect Creek Stormwater Management Plan*

Table 2b: Pollutant Retention Criteria for Greystanes Creek Catchment

Pollutant	Description	Retention Controls
Litter	All anthropogenic material	70% of objects 5mm diameter or great
Coarse Sediment	Coarse sand	80% of the load particles 0.5mm or less
Nutrients	Total phosphorus and Total Nitrogen	45% retention of the load
Fine Particulates	Fine sand	50% of the load for particles 0.1mm dia. or less
Cooking Oil and Grease	Free Floating Oils that do not emulsify in aqueous solutions	90% of the load with no visible discharges
Hydrocarbons	Anthropogenic hydrocarbons that can be emulsified	90% of the load with no visible discharges

Source: Upper Parramatta River Catchment Stormwater Management Plan

#### Stormwater Pollution Load Assessment in Pemulwuy

To provide preliminary sizes for the water quality ponds, a level one pollution load assessment was completed, as defined in the EPA guidelines. The recommended total wetland pond sizings are:

- Greystanes Creek catchment – 2.2 hectare surface area; and
- Prospect Creek catchment – 0.75 hectare surface area.

The above pond sizings are subject to confirmation by AQUALM modelling. The proposed Drainage Strategy is shown in Figure 75.

### 3.9.4 Source, Conveyance and Discharge

#### Objectives

- O1. Adopt within the stormwater plans three types of runoff quality controls. In summary, the controls are:
  - source controls - controls applied to the individual lots to address specific pollutants associated with the specific development;
  - conveyance controls - controls applied to the local and trunk drainage systems which may include grass swales, and streams incorporating ponds, ripple zones and macrophytes; and
  - discharge controls - controls applied to piped or channelised drainage systems prior to discharging in creeks or water quantity/quality control basins. These include gross pollutant traps, wetlands and water quality control ponds.
- O2. Use Source controls to reduce runoff rates and minimise the pollutant loads discharged from individual development sites.

- O3. Apply Conveyance Controls to the local and trunk drainage systems to minimise the pollutant load transferred from the development sites to the discharge points.
- O4. Use Discharge Controls to ensure that water quality targets in the Stormwater Management Plan are achieved.

### **Controls**

#### Source Control

- C1. Use Stormwater Harvesting – i.e.: maximise the amount of stormwater run-off used on the development, minimise impervious areas and, where possible use pervious paving systems.
- C2. Install rainwater tanks along with water correcting fittings in accordance with the principles of Water Sensitive Urban Design.
- C3. Use Buffer Strips, where the development lot layouts allow, where the landscaping is used to treat run-off. Use vegetated buffer strips to reduce the amount of fine sediment and nutrients discharged from the lot to the stormwater system.

#### Waterway protection control

- C4. Protect and enhance the main watercourse flowing through Pemulwuy as a natural stream system.
- C5. Collect treated stormwater.
- C6. Include in the watercourse a meandering natural runoff channel with aquatic and terrestrial riparian vegetation.
- C7. Where feasible, include in the watercourse a meandering low flow invert, ponds and ripple zones, and aquatic and riparian vegetation.

#### Discharge control

- C8. Provide Gross Pollutant Traps incorporating a screen and coarse sediment sump upstream of the discharge points into the main creekline and not in the core riparian corridor.
- C9. Design these to achieve the pollutant reduction targets set out in Tables 1 and 2 for coarse sediment and litter.
- C10. Design the traps for cleaning by Cumberland City Council's drain cleaning equipment in order to minimise maintenance and cleaning costs.
- C11. Provide integrated water quantity and water quality control ponds in the regional basin in Pemulwuy North. Ensure the ponds have been sized to meet the treatment objectives for sediments and nutrients outlined in the stormwater management plans.
- C12. The ponds should consist of a series of shallow, densely planted zones and deep water areas.
- C13. Locate a device immediately upstream of the basin to prevent floating pollutants and pollution spills entering the basin.

### 3.9.5 Residential Catchment 'A' Flow Management (+ Detention ponds)

#### **Objectives**

- O1. Design and maintain development so that existing peak flows from the Fox Hills basin are not adversely affected, taking into account the planned residential developments in the Catchment, and proposed modifications to the central basin.
- O2. Ensure that the stormwater system for any development does not increase the downstream flooding of Pemulwuy.
- O3. Convey stormwater within the northern Catchment A of Pemulwuy in the riparian channel/corridor of Greystanes Creek.
- O4. Ensure the riparian channel/corridor of Greystanes Creek is part of an important recreational, ecological and visual linear park system capable of conveying the 1 in 100 year average recurrence interval flows.
- O5. Link the drainage corridor with water bodies so as to maintain suitable water quality as well as provide further habitat.
- O6. Ensure that development does not adversely affect pollution levels in the catchment.

#### **Controls**

##### General

- C1. As part of any application for the subdivision of land in the Residential Catchment A (to Greystanes Creek), identify such proposals and confirm arrangements to be made for the expansion of the flood basin to attenuate post-development flows and treat run-off quality.
- C2. Should it prove impractical or impossible, for whatever reason, to satisfy storage and quality treatment objectives with the flood basin, provide alternative arrangements within the built environment.
- C3. Implement the stormwater management measures outlined above during construction. If sediment from the Residential Catchment A (to Greystanes Creek) is deposited off site in the basin or the downstream creek channel during development and construction on the site, remove it at regular intervals and prior to completion of construction.
- C4. Provide the following drainage infrastructure:
  - drainage corridor along central spine;
  - water pollution control within the basin;
  - detention storage within the basin;
  - creek works to accommodate flows;
  - collect runoff from Council drainage system which discharges from Greystanes Road onto the site;
  - outlet structures;
  - gross pollutant traps;
  - pipe drainage; and
  - overland flow paths.
- C5. Ensure that the community based detention system negates the requirement for on-site detention on individual development lots, as specified in the UPRCT on-site detention policy.

- C6. Consider sourcing water from the detention basin to irrigate public reserves in the area, subject to the maintenance of environmental flows to Greystanes Creek.
- C7. Ensure wetland planting (macrophyte zones) on the foreshore of the new basin will further increase the ability of the basin to improve stormwater quality.

Stormwater detention (Catchment A)

**Objectives**

- O7. Ensure that the stormwater runoff generated from this portion of the western precinct does not adversely affect peak flows, velocities and water levels downstream of the existing regional basin (refer to Figure 76).
- O8. Design on-site detention that is consistent with the conceptual modelling by Patterson Britton This modelling has identified a required storage which can be accommodated between the road and existing basin.

**Controls**

- C8. Design on-site detention that is consistent with the conceptual modelling by Patterson Britton (see Figure 76 and 77).
- C9. Ensure that detailed design of the basin is integrated with the landscape setting.
- C10. Submit details of the basin to Council as part of the Development Application for the relevant stage.
- C11. Locate the proposed stormwater detention basin outside the CSIRO basin 100-year flood zone.
- C12. Provide preliminary sizes for the water quality ponds, a level one pollution load assessment was completed, as defined in the EPA guidelines. Ensure that the recommended total wetland pond sizings are:
  - Greystanes Creek catchment – 2.2 hectare surface area; and
  - Prospect Creek catchment – 0.75 hectare surface area.

*Note: The above pond sizings are subject to confirmation by AQUALM modelling. The proposed Drainage Strategy is shown in Figure 75.*





Figure 76: On site detention concept



Figure 77: On site detention detail

### 3.9.6 Residential Catchment 'B' Flow Management

The Southern Residential Catchment B is located in the Prospect Creek catchment, and stormwater management plans have been prepared by Cumberland City Council for these local catchments.

Fairfield City Council requires that there be no significant adverse impacts on flood levels in Prospect Creek. Refer to the Prospect Creek Stormwater Management Plan.

#### Objectives

- O1. Design and maintain development in the Residential Catchment B (to Prospect Creek) so that downstream flows are not adversely affected, based on a comparison of peak flows, velocities and water levels in the 2 % AEP, 1% AEP and probable maximum floods at critical points downstream.
- O2. Provide pollutant retention criteria for new developments and treatment objectives for various types of developments, through the stormwater management plans.
- O3. Ensure that the stormwater runoff generated within Catchment B does not adversely affect peak flows, velocities and water levels within Prospect Creek.

**Controls**

- C1. Implement the stormwater management measures outlined above during construction.
- C2. If sediment from the Residential Catchment B (to Prospect Creek) is deposited off site in the downstream creek channel during development and construction on the site, remove it at regular intervals and prior to completion of construction.
- C3. Provide integrated water quantity and water quality control ponds at each of the discharge points within the site.
- C4. Provide the following drainage infrastructure:
  - shaping drainage corridor to various outlets;
  - water pollution control pond(s);
  - detention storage;
  - gross pollutant traps;
  - pipe drainage; and
  - overland flow paths.
- C5. Ensure that the community based detention system will negate the requirement for on-site detention on individual development lots, as specified in the UPRCT on-site detention policy.
- C6. Ensure that the recommended total wetland pond sizings are:
  - Prospect Creek catchment – 0.75 hectare surface area; and
  - Greystanes Creek catchment – 2.2 hectare surface area.

*Note: The above pond sizings are subject to confirmation by AQUALM modelling.*

3.9.7 Stormwater Documentation Requirements

**Objectives**

- O1. Comply fully with Cumberland City Council's OSD policy and the Upper Parramatta River Catchment Trust handbook.
- O2. Accommodate capacity for future development of the adjoining residential lands.

**Controls**

- C1. Prepare detailed Hydraulic plans to accompany Development Applications for subdivision.
- C2. Detail conveyance of existing and proposed overland flows to the satisfaction of Council.
- C3. Design all overland flow paths and corridors to accommodate storm events stipulated under the Section below on Flood Risk Management.
- C4. Land located along the southern boundary of the Residential Lands may be required to convey a large volume of overland flow from the existing adjoining property to the south/south west. To ensure that overland flow within this portion of the western precinct is adequately conveyed, Development Applications for subdivision of this area shall include the following details and must comply fully with Cumberland City Council's OSD policy and the Upper Parramatta River Catchment Trust handbook:
  - a fully detailed catchment analysis in order to determine existing overland flows; and

- a fully detailed hydraulic report and associated plans which indicate proposed method of conveying overland flows.
- C5. Overland flow paths shall be designed so as to accommodate capacity for future development of the adjoining residential lands.
  - C6. Provide Stormwater Plans to accompany development applications for individual lots in Pemulwuy.
  - C7. Ensure these plans are consistent with stormwater management plans prepared by Council, under direction from the EPA.
  - C8. Adopt within the stormwater plans three types of runoff quality controls - Source, Conveyance and Discharge.

### 3.9.8 Water Bodies Management

#### **Objectives**

- O1. Provide a safe and efficient urban water management system.
- O2. Contribute to the amenity, appearance and urban structure of Pemulwuy.
- O3. Achieve multiple use of drainage systems.

#### **Controls**

- C1. Utilise the Pemulwuy North regional detention basin to control runoff rates and quality in Catchment A (incorporating Pemulwuy North and the Northern Residential Catchment of Pemulwuy South).
- C2. Utilise Ponds to control runoff rates and quality in Catchment B (namely the Southern Residential Lands of Pemulwuy South).
- C3. Maximise use of regional facilities to achieve the runoff flow rate and water quality controls.
- C4. Assess adequacy of water quality pond sizes using AQUALM model for construction certificate approval.
- C5. Integrate bush regeneration in the agreed core riparian zone to achieve a fully vegetated corridor of local native trees, shrubs and groundcover species and native macrophytes in the water quality ponds. Areas outside the core riparian zone can be multifunctional.
- C6. Integrate the landscaping with the design of the waterbodies to improve the amenity of the area.
- C7. Include emergent macrophyte plantation in the basin for control of nutrients. All control of sediment must be via source control before entering the Creek.
- C8. Ensure the spillway outlet from the basin maintains a continuous downstream environmental flow as approved by Cumberland City Council.
- C9. Prepare an operational plan for all ponds which is integrated across the entirety of Pemulwuy. The operational plan should set out how the main water bodies will be managed in terms of maintenance, safety, nominating activities, frequency and

responsible authorities. This should be in accordance with the requirements of the *Constructed Wetlands Manual* (DLWC 2000).

- C10. Design outlet to the ponds to allow water levels to be varied for aquatic plant management.
- C11. Regularly maintain gross pollutant traps and coarse sediment sumps to prevent a build up of sediment in main water bodies.
- C12. Rehabilitate and protect the existing Creek.

### 3.9.9 Flood Risk Management

#### **Objectives**

- O1. Prevent the negative impact of water on human life and property.
- O2. Prevent the negative impact of development on the receiving waters of the catchment.

#### **Controls**

- C1. Accommodate the minor drainage system flows in pipes with capacity no less than the 5 year ARI storm.
- C2. Accommodate flows in excess of the capacity of the minor system in overland flow paths and corridors (major systems), up to the 1 in 100 year ARI storm on the roads and open space.
- C3. Provide multiple uses for drainage corridors incorporating a naturalistic meandering low flow channel with a series of pools and ripple zones.
- C4. Locate habitable floor levels and developable land, other than open space, at least 0.5m above the Greystanes Creek 100 year ARI flood level.
- C5. Provide appropriate flood hazard warning signage where appropriate.
- C6. Design Butu Wargun Drive to provide a flood-free evacuation route in the event of a probable maximum flood (PMF).
- C7. Integrate flood detention and water quality control basins for the Catchment B (Prospect Creek) Lands.

### 3.10 Environmental Management

Redevelopment of the former CSIRO site and Boral lands into the Pemulwuy residential lands requires the implementation of numerous environmental management measures to ensure an environmentally sound and sustainable development.

#### 3.10.1 Site Contamination and Remediation

The residential lands of Pemulwuy have been the subject of a number of site investigations concentrating on identifying areas of environmental concern (AEC) relating to former non-residential activities on the land. These AEC included quarrying, laboratories, chemical storage areas, sheep dips and waste disposal areas. These AEC have been investigated and (where necessary) remediated. The work conducted in assessing and remediating these AEC has been signed off by a NSW Environment Protection Authority (EPA) auditor through the issuing of Site Audit Statements. This does not exclude the need for future assessment and remediation of future AEC at Pemulwuy.

##### Objectives

- O1. Ensure the appropriate assessment, remediation, validation and auditing of potentially contaminated land to reduce the risk of harm to human health or the environment.
- O2. Ensure land is suitable for the intended use.
- O3. Ensure that future occupants or workers at the site are not exposed to contaminated materials.
- O4. Follow the contamination management strategies produced for the various precincts of Pemulwuy.

##### Controls

- C1. During bulk earthworks activities, initiate an unexpected findings protocol to address the potential discovery of contaminated soil or other hazardous materials.
- C2. As a result of the protocol, ensure that appropriate assessment, and (where necessary) remediation and validation occurs.
- C3. Make provision in the protocol to inform Council of the discovery of such materials.
- C4. Before the lodgement of any development application for the site, complete a groundwater Assessment in accordance with 'Schedule B(6) Guidelines for Risk Bases Assessment of Groundwater Contamination' in the *National Environmental Protection Councils National Environment Protection (Assessment of site Contamination) Measure (1999)*.
- C5. Remediation is required to render the site suitable for the proposed land use, consistent with:
  - the *Contamination Management Strategy* (prepared by Environmental and Earth Sciences and RES for Pemulwuy North); and
  - the *Remediation Action Plan* (prepared by HLA Envirosciences for Pemulwuy South).
- C6. Ensure the remediation of the site is certified by a NSW EPA Accredited Site Auditor.

*Note: Building waste and asphalt waste have been classified by the NSW EPA as 'inert waste' (Table 1, NSW EPA 1999 - Environmental Guidelines: Assessment, Classification and Management of Liquid and Non-Liquid Wastes).*

*Therefore, materials meeting this description, and meeting the physical and other criteria stipulated in the Material Management Guidelines (HLA 2001, prepared for Pemulwuy South) are not considered to be contaminated, and are therefore not part of the remediation works.*

### 3.10.2 Earthworks Management

#### **Objective**

- O1. Ensure that any fill utilised throughout the site is clean and complies with relevant standards.

#### **Controls**

- C1. Determine a Phase 1 Contamination Investigation by an environmental consultant.
- C2. Evaluate each portion of the estate as required by the Phase 1 Investigation for:
  - existing condition down to bedrock;
  - groundwater monitoring; and
  - validation of both fill zone foundation and proposed fill material to provide material within acceptable EPA criteria for re-use.
- C3. Obtain approval of the above by a NSW EPA Accredited Site Auditor to allow placement of fill and the excavation and re-use of on-site material to provide a revised landform.
- C4. Upon the validation and approval of fill foundation and fill material, place and compact material generally in accordance with:
  - all material <300 mm in size;
  - compaction up to 98% standard compaction to building and road lots;
  - moisture content 60-90% of optimum;
  - compaction to 95% standard in landscaped areas. Landscaped areas should then be ripped to a depth of 300/450 mm and organic material should then be mixed to improve soil quality as required; and
  - fill to be placed in layers no more than 300mm thickness.
- C5. Ensure that final verification of placement of clean fill material is undertaken through the process of design/construction Quality Assurance Audits and validated by a NSW EPA Accredited Site Auditor.
- C6. Minimise the potential for establishment of perched water tables at the fill/natural soil interface by ensuring that drainage is established between the 2 layers.

### 3.10.3 Waste Management

#### **Objectives**

- O1. Minimise waste generation and disposal to landfill during demolition and construction works in accordance with the "waste hierarchy" (which means promoting source separation and subsequent reuse/recycling of materials over and above disposal).
- O2. Ensure that reuse/recycling options are utilised at every opportunity and that any necessary waste disposal is lawful and efficient.

- O3. Ensure that the provision of adequate and appropriate storage area for waste and recyclables during all stages of development.
- O4. To maximise the amenity of the development and opportunity for reuse/recycling by residents through effective design of facilities.

**Control**

- C1. Integrate waste management planning process into all stages of development.
- C2. Provide source separation facilities (e.g. waste bays) on building sites so that different materials may be easily separated during demolition and construction works. This will maximise the potential for reuse/recycling during demolition and construction works.
- C3. Locate garbage/recycling storage areas in Type D developments so as to be easily serviced, and to not cause any negative impacts in terms of visual appearance, noise or smell, to adjoining properties or to the street.
- C4. Provide waste separation facilities in all Type D kitchens to encourage the separation of waste at its source.
- C5. Use ventilation stacks wherever possible (and necessary) to vent shops and basements.
- C6. Submit a Site Waste Minimisation and Management Plan (SWMMP) in accordance with Part G of this DCP with any development application prior to development approval.

3.10.4 Soil Erosion & Sediment Control

Soil Erosion & Sediment Control in Pemulwuy is controlled by Part G, Soil Management.

The control measures are to be in accordance with the Managing Urban Stormwater Guidelines including the *Managing Urban Stormwater: Soils and Construction* published by the Department of Housing, and have been incorporated into the stormwater management strategy described above in Section 3.9 entitled Stormwater and Flooding Management.

3.10.5 Salinity

Salinity within Pemulwuy is controlled by the *Cumberland Local Environmental Plan 2021*, under Salinity in the Pemulwuy Precinct.

The draft *Salinity Hazard Mapping for Western Sydney* (DLWC 2000) indicates areas along Greystanes Creek to be classified as an area of extensive salinity hazard, with the remaining land to be areas of localised hazard.

Potential salinity on the site is therefore considered to be an environmental constraint which requires appropriate management.

**Objectives**

- O1. Minimise disturbance to natural hydrological systems as a result of development, and to provide for appropriate management of land affecting the process of land salinisation, or affected by salinity.
- O2. Prevent damage to buildings and infrastructure in urban areas caused by salinity.
- O3. Identify areas of the site that have sufficient cover of non-saline soils to warrant no formal salinity treatments.



- O4. Increase the volume of non-saline soils won from road reserves, etc to be utilised as an “asset” in managing actual salinity affected soils, building sites, drainage and landscaping works.
- O5. Decrease the volume of salinity affected soils that require treatment/management.

### **Controls**

- C1. Prepare a soil salinity management strategy for each stage of development. The main components of the strategy should include:
  - review of existing geotechnical and geochemical site data to refine interpreted distribution of non-saline A and B1 Horizons and slightly to moderately saline B2 and C Horizons;
  - additional investigations to further refine the soil salinity data base;
  - co-ordinate subdivision design to optimise earthworks and civil works in relation to soil salinity management. Initiatives could include but not be limited to:
    - winning/stockpiling A and B1 Horizon materials from road reserves and other areas prior to filling;
    - considering lime stabilised subgrades to enable reduced pavement thicknesses and
    - decreased excavation volumes of potential salinity affected soils from road reserves;
    - scheduling salinity affected soils to be placed at depth in fill areas; and
    - gypsum/lime modification to B1 Horizon sourced fill or in situ material to improve soil condition for revegetation capacity and rate.
  - prepare and implement an “earthworks management plan” for each subdivision stage: this work should include basic terrain evaluation so that earthworks methods can be tuned for slight, moderate and steep slopes. Induct the earthworks contractor and machine operators on relevant aspects of the earthworks strategy;
  - implementation and validation of the earthworks management plan will include stockpile quality assurance and management and a level of geotechnical supervision that will require regular engineering inputs in addition to technical inputs for compaction control; and
  - assessment of the need for further salinity management interventions during residential construction, e.g. granular vapour barriers, lime/gypsum treatments, durable concretes, suspended floor construction, etc.

### Monitoring

- C2. Complement baseline monitoring of soil salinity (performed prior to development) by ongoing monitoring during the development phase to determine any potential changes and inform future stages/sites.
- C3. Prepare a salinity monitoring program by an appropriately qualified person.
- C4. The monitoring program should consist of monthly sampling, in addition to sampling after rainfall events greater than 20mm in 24 hours.
- C5. Prepare a report consolidating the results of the first 12 months of monitoring and submitted to Council.
- C6. Locate the monitoring wells shall be located to facilitate the long term monitoring of the deep and shallow water tables.

- C7. Salinity monitoring shall be the responsibility of the owner of the land.

Site design

- C8. Avoid disturbance of natural flow lines and the use of cut and fill construction techniques without adequate alternative drainage provisions - this is where the salinity is first likely to appear.
- C9. Retain native vegetation along watercourses.
- C10. Rehabilitate disturbed areas using native vegetation.

Stormwater and drainage

*Note: Salinity problems generally occur in the areas where water accumulates, or which are subject to continuous wetting and drying cycles. This can be where natural through flow or surface flow is impeded by buildings, or by associated retaining walls or land resurfacing. Therefore:*

- C11. Ensure correct drainage, which helps protect foundations, footings and walls from salt attack.
- C12. Avoid areas of impeded sub-surface flow and the interception of groundwater.
- C13. Minimise deep infiltration and throughflow when designing stormwater management.
- C14. Design and construct detention and retention basins to avoid high velocity runoff and soil erosion in susceptible areas, and for ease of maintenance.

Building slabs/concrete

- C15. In order to prevent moisture rising through the slab, firstly lay a thick layer of sand on the site. Next, lay a damp-proof membrane of thick plastic.
- C16. Make concrete more resistant to salinity by increasing its strength to reduce the permeability.
- C17. Consider using a sulphate resistant concrete, which will reduce reinforcement corrosion. Minimum of 65 millimetres of concrete cover on strip or slab reinforcement is recommended in saline environments. Compaction and curing of the concrete are also advised.
- C18. Consider suspended slab or pier and beam housing construction methods, to minimise the expose of building materials to corrosive elements and to minimise cut and fill so that groundwater and sub-surface water flow is not impeded.

Bricks

- C19. Consider a brick damp course, which if correctly installed, will prevent moisture moving into the bricks.
- C20. Consider salt resistant bricks (or exposure quality bricks) and concrete. These are available and are more suitable for use in saline environments.
- C21. Consider adding waterproofing to the mortar to prevent water entry.
- C22. Vegetation and landscaping:

Favour gardens which do not require a lot of watering. This includes:

- use of native plants which do not require excess watering;
- deep rooted trees to prevent the ground water table rising;
- the use of mulch; and
- the reduction of lawn areas.

C23. Do not locate gardens close to buildings, as watering may affect foundations or render the dampcourse ineffective.

### 3.10.6 Noise and Vibration Management

#### **Objectives**

- O1. Achieve external noise goals where feasible or reasonable.
- O2. Where this is considered impractical, to achieve internal noise criteria by appropriate façade treatment.

#### **Controls**

##### External noise levels

- C1. Achieve the Road Traffic Noise Criteria for Residential Receivers as detailed in Table 3.
- C2. Achieve the Industrial Noise Criteria for Residences adjoining Clunies Ross Street as detailed in Table 4. In particular, though not exclusively.

##### Internal noise levels

- C3. Achieve the Internal noise criteria for both traffic and industrial noise in habitable areas as detailed in Table 5.



Figure 78: Area requiring acoustic treatment

Table 3: Road Traffic Noise Criteria for Residential Receivers

Type of Development	Day (7:00am - 10:00pm)	Night (10:00pm- 7:00am)	Where criteria are Already Exceeded
New residential land use developments affected by freeway/arterial traffic noise.	LAeq (15hour) 55dBA	LAeq (9hour) 50dBA	Where feasible and reasonable, existing noise level should be reduced to meet the criteria via judicious design and construction of the development. Location, internal layouts, building materials and construction should be chosen so as to minimise noise impacts.
New residential land use developments affected by freeway/arterial traffic noise.	LAeq (1hour) 55dBA	LAeq (1hour) 50dBA	Where feasible and reasonable, existing noise level should be reduced to meet the criteria via judicious design and construction of the development. Location, internal layouts, building materials and construction should b
<i>Note: These criteria are non-mandatory in nature and the design solutions should take into account cost, feasibility and equity and community preferences.</i>			

Table 4: Industrial Noise Criteria for Residences adjoining Clunies Ross Street

Time of Day	Intrusive LAeq (15minute) Criterion for New Sources	Amenity LAeq(period) Criterion for New Sources
Day	51dBA	47dBA
Evening	51dBA	44dBA
Night	46dBA	42dBA

Table 5: Internal noise criteria for both traffic and industrial noise in habitable areas

Internal Space	Time Period	Noise Level
Sleeping Areas	Day (7:00am to 10:00pm)	LAeq(1hour) 40dB(A)
	Night (10:00pm to 7:00am)	LAeq(1hour) 35dB(A)
Other Living Areas	Day (7:00am to 10:00pm)	LAeq(1hour) 45dB(A)
	Night (10:00pm to 7:00am)	LAeq(1hour) 40dB(A)

Sleep arousal design

- C4. For the purpose of setting an acceptable sleep arousal criterion, and taking into consideration the duration of noise level events such as those associated with trucks

near or on Clunies Ross Street for example, adopt the Finegold approach, as documented in the *Environmental Criteria for Road Traffic Noise* (ECRTN; Office of Environment and Heritage, or its equivalent).

- C5. Adopt a design indoor sleep arousal ASEL (A-weighted Sound Exposure Level) of 57 dBA to protect future residences, such as those facing Clunies Ross Street.
- C6. Limit noise impacts from vehicle traffic upon nearby and adjoining residential land by permitting bus only access on Butu Wargun Drive between the residential and industrial areas.
- C7. In the event that Butu Wargun Drive is open to other classes of traffic, the consent authority must consider the noise impacts likely to arise, in particular, whether the ECRTN criteria relevant to Pemulwuy residential areas will be exceeded.

Measuring traffic noise

- C8. Where required, quantify the external acoustic environment using the methods outlined below. Methods departing the procedural requirements outlined should be supported by a scientifically valid rationale to demonstrate that the method is no less accurate than that described.
- C9. Undertake preliminary LAeq (1hour) noise measurements between the periods 7:00am to 9:00am or 4:00pm to 6:00pm.
- C10. Where the measured facade corrected LAeq (1hour) exceeds 55dBA, the requirements of this Plan are triggered and long-term, unattended measurements are required.
- C11. Conduct long-term, unattended measurements over a minimum of three consecutive weekdays (ie Monday to Friday, not weekends).
- C12. Conduct noise measurements in accordance with *Australian Standard AS2702-1984 – Acoustics – Methods for the Measurement of Road Traffic Noise*.

*Note: LAeq(1hr) is the LAeq noise level for a specific 1 hour period. For assessment purposes, the LAeq(1hr) represents the highest tenth percentile hourly A-weighted Leq noise level (or if this cannot be accurately defined, the LAeq noise level for the noisiest hour) during the period 7:00am to 10:00pm or the period 10:00pm to 7:00am, as relevant.*

- C13. Measure LAeq on a 15-minute basis. To calculate the logarithmic average over a 1 hour period,  $LAeq(1hr) = 10 \times \log_{10} \left( \frac{\sum_{i=1}^{40} (LAeq,15min,i/10)}{4} \right)$ , where there are 4 X 15 minute measurements conducted over a 1 hour period.
- C14. Carry out noise measurements in positions representative of the nearest facade noise level. Where this is not possible, select a location where accurate extrapolation of the facade noise level can be made from the measurement position.
- C15. Where measurements are acquired in the free field façade, apply correction factor of +2.5 dBA.

Measuring industrial noise

- C16. Conduct operator-attended noise measurements, supplemented by long-term noise logging where appropriate, at residential areas adjacent to Clunies Ross Street.

- C17. Noise measurement procedures shall be generally guided by the requirements of AS 1055-1997 “Acoustics - Descriptions and Measurement of Environmental Noise” and the NSW Industrial Noise Policy (INP) 2000.
- C18. Carry out noise measurements in positions representative of the yard areas of present and future residences.

Operating conditions of the building – ventilation measures

- C19. Where the indoor design noise levels cannot be satisfied with windows open to an area of 5% of the floor area of the room under consideration, alternative means of ventilation are required.
- C20. The following hierarchy of alternatives should be considered in the options analysis with (i) being most preferred and (ii) least preferred:
- i) Design the building to ensure that passive ventilation will not seriously compromise the acoustic integrity of the building. Noise sensitive uses should be located as far as practicable from noise sources. Windows should be orientated away from noise sources.
  - ii) Provide the building with mechanical ventilation satisfying the requirements of the Building Code of Australia.
- C21. For the purpose of design analysis, a room by room approach is acceptable and hence assumes that internal doors are closed and that negligible noise transfer between rooms occurs. If a perimeter approach is adopted, the lower indoor design noise level shall be adopted for the composite space.

Acoustic compliance reporting

- C22. Accompany Development Applications by a Preliminary Report demonstrating compliance with established noise levels (see Tables 3 and 4).
- C23. Where measured noise levels exceed criteria, state in the Preliminary Report whether a Design Report for road traffic or industrial noise is required.
- C24. Ensure that the preliminary report, as a minimum includes:
- a site plan of the development proposal showing the locating of the noise measurement locations;
  - a summary of the measured industrial or adjusted facade traffic noise levels; and
  - a statement qualifying whether the measured noise levels comply with established noise criteria and whether a Design Report is required.
- C25. Where the Preliminary Report demonstrates that a Design Report is applicable, (that is, where the preliminary road traffic or industrial noise measurements exceed the noise goals detailed in Tables 3 and 4), submit a design report with the Development Application.
- C26. The design report shall include:
- a site plan of the development proposals showing the location of the noise measurement points;
  - where applicable a graphical representation of the acquired road traffic or industrial noise data;
  - tabulated results of operator attended noise measurements;



- a statement quantifying the measured or adjusted facade noise levels derived for design purposes for road noise or, in the case of industrial noise levels, at the yard areas of residential properties;
  - recommendations for specific noise controls to satisfy the design noise goals; and
  - a statement indicating that the design noise levels will be achieved following the effective implementation of the required noise controls.
- C27. Following completion of the attenuation measures, submit a statement from “an acoustic consultant having the technical eligibility criteria required for membership of the Association of Australian Acoustical Consultants (AAAC) and/or grade membership of the Australian Acoustical Society (MAAS)”, clearly indicating that the acoustic recommendations of the design report have been satisfactorily incorporated.
- C28. Submit the validation statement to Council/Principal Certifying Authority (PCA) prior to the issue of Subdivision/Occupation Certificates.

### 3.10.7 Air Quality Management

#### **Objectives**

- O1. Minimise trip length and encourage the use of pedestrian/cycleways.
- O2. Reduce traffic emissions overall by improvement of local bus services and linkage to major transport routes and transitways.
- O3. Improve energy efficiency through design and orientation of houses.

#### **Controls**

- C1. Design roadways to minimise trip length and encourage the use of pedestrian/cycleways.
- C2. Locate and provide access to services and facilities in order to minimise trip length and encourage the use of pedestrian/cycleways.
- C3. Include linkages to centres of employment, cultural and natural interest to minimise trip lengths.
- C4. Improve local bus services and linkages to major transport routes and transitways.
- C5. Design and orientate houses for energy efficiency.

This page has been left intentionally blank.



CUMBERLAND  
CITY COUNCIL

# PART F1-15

## RAAF STORES DEPOT

This page has been left intentionally blank.

# 1. Introduction

## 1.1 Land to which this Part applies

This Part applies to land zoned R3 Medium Density Residential within the Former RAAF Stores Depot site under *Cumberland LEP 2021*. Refer to Figure 1 below.



L:\Auburn Mapping\DCP\DCP 2009\RAAF Storage\_Residential

Figure 1: Area to which this Part applies.

## 1.2 Purpose of this Part

The purpose of this part is to provide land use provisions to guide redevelopment of the former RAAF Stores Depot site.

## 2. General objectives

- O1. Encourage design that will enhance the existing character of the locality; and
- O2. Ensure that redevelopment is integrated with the surrounding development.

## 3. Specific objectives and controls

### 3.1 Residential density and dwelling mix

#### Objectives

- O1. Encourage a range of housing types to meet the needs of the community.
- O2. Provide interesting and varied streetscapes.
- O3. Ensure development is not excessive in scale and the distribution of housing forms reflects the scale and character of existing development.
- O4. Incorporate a range of dwelling types and sizes. Locate higher density housing to act as a buffer to industrial development to the south of the site.

#### Controls

- C1. Residential development shall not exceed a gross residential density of 28 dwellings per hectare.
- C2. Courtyards shall not be built within the front building alignment.
- C3. Single dwelling traditional lot development shall occur along the interface with existing residential areas.

### 3.2 Car parking

The applicant shall refer to Part G of this DCP.

### 3.3 Noise

The applicant shall refer to Part B of this DCP.

### 3.4 Adaptable housing

The applicant shall refer to the relevant adaptable housing provisions in Part B of this DCP.

### 3.5 Stormwater management

The applicant shall refer to the Part G of this DCP.

### 3.6 Tree preservation

The applicant shall refer to Part G of this DCP.

### 3.7 Public domain

The applicant shall refer to the *Former RAAF Stores Depot Public Domain Plan* for public domain requirements. This Plan is available from Cumberland City Council on request.

This page has been left intentionally blank.





CUMBERLAND  
CITY COUNCIL

# **PART F1-16**

# **SHERWOOD SCRUBS**

# **AND ADJOINING LAND**

This page has been left intentionally blank.

# 1. Introduction

## 1.1 Land to which this Part applies

This section applies to Lots 1 DP 1002887 and Lot 12 DP 1075418 (“The Site”) on Kenyons Road, Merrylands.

# 2. Specific Objectives and Controls

### Objectives

- O1. Ensure that the siting of any future development are appropriate to the locality and of significant vegetation and natural or built heritage are preserved;
- O2. Ensure that future development meets sound environmental practices and standards; and
- O3. Encourage adaptive re-use and restoration of heritage buildings within the site.

### Controls

- C1. Any dwelling or other building erected within Lot 1 DP1002887 shall be wholly contained within a designated “Residential Precinct” as identified on Appendix A.
- C2. Unless otherwise directed by Council, all existing trees greater than 3.5m in height external to a designated “development precinct” are to be protected and preserved.
- C3. As far as possible, disturbance of the ground surface within the drip line of all trees over 3.5m in height is to be avoided. All dwellings, structures and access roads are to be located to avoid disturbance of the following individual specimens:

*Table 1: Identified Species –disturbance to be avoided*

Tree Number*	Description
312	Broad-leaved Ironbark
192	Mature Grey Box
193	Mature Grey Box
249	Mature Grey Box

(\* Tree Numbers as identified on Appendix A)

- C4. The design of the second storey should be integrated into the overall dwelling design and the reduced building footprint should assist in the retention of trees.
- C5. Preservation of existing trees within designated “Residential Precincts” is to be maximised by the appropriate siting of dwellings, buildings and associated private open space areas. Specific trees likely to be affected by the siting of dwellings or structures are to be clearly identified on any plans for erection of such and may only be removed with the express consent of Council.

- C6. Development within Lot 1 DP1002887 shall make provision for establishment and maintenance of a “Native Vegetation Precinct”. The location and extent of this precinct is to be as shown on Appendix A.

## **2.1 Specific Requirements applying to Lot 12 DP 1075418**

### **Objective**

- O1. Ensure the heritage significance of this site is retained.

### **Controls**

- C1. The provisions of *Cumberland Local Environmental Plan 2021* with respect to adaptive re-use of heritage items apply to this site.
- C2. Any application to Council for adaptive re-use and/or residential development within this lot shall be accompanied by a Conservation Plan prepared by a suitably qualified architect.
- C3. The Conservation Plan will:
- describe the significance of buildings, structures and their setting as part of the environmental heritage of Cumberland City;
  - consider appropriate steps for conservation of identified elements to be undertaken in conjunction with the proposed development; and
  - describe appropriate steps to mitigate any adverse impact on the heritage significance of identified elements arising as a result of the proposed development.

### 3. Appendix A – Guidelines for Development

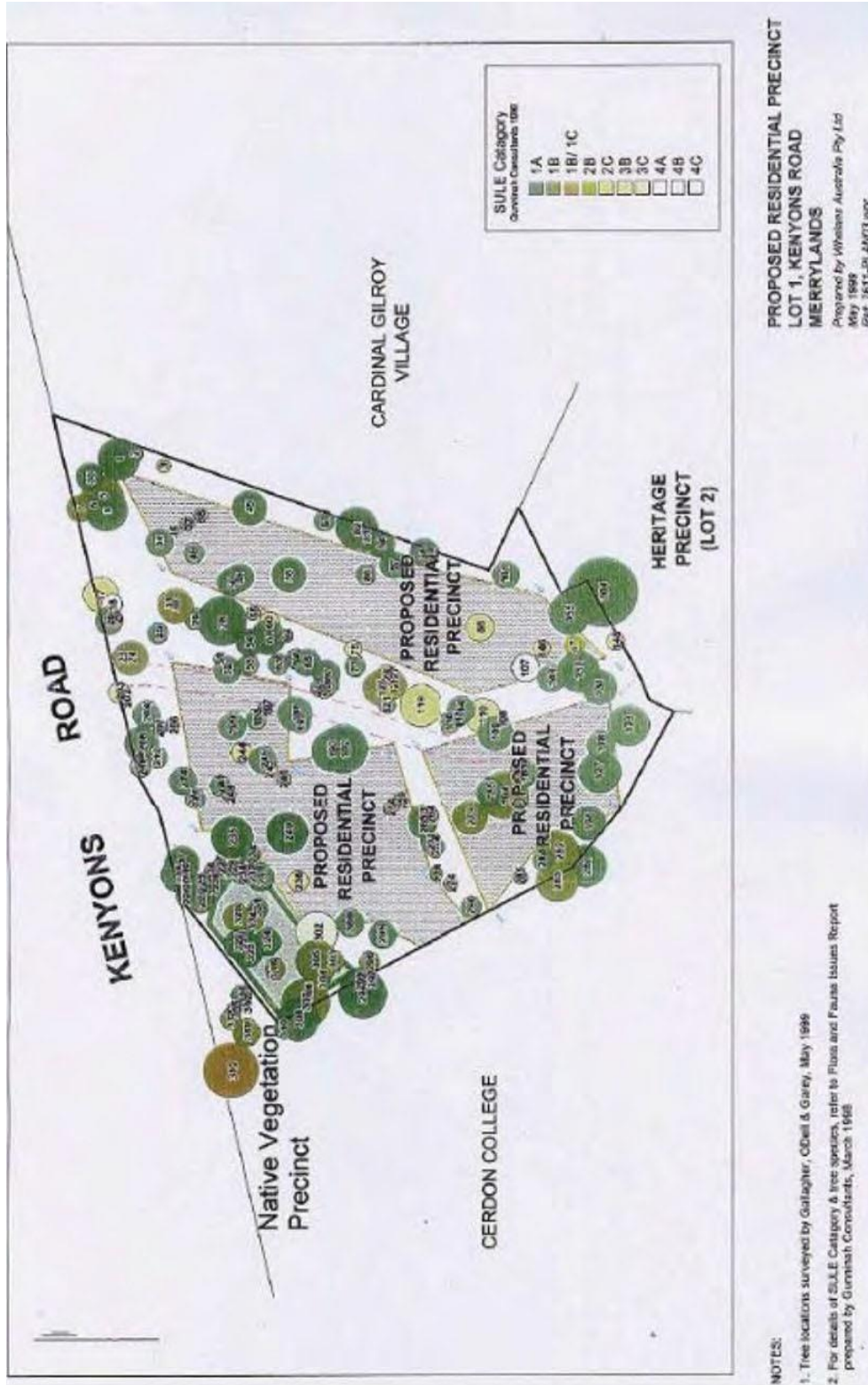

This page left intentionally blank



CUMBERLAND  
CITY COUNCIL

# **PART F1-17**

**45 BARCOM STREET,  
MERRYLANDS WEST  
(CARDINAL GILROY VILLAGE)**



## 1. Introduction

### 1.1 Purpose of this DCP

The DCP outlines the 'site specific controls' (the detailed planning and design framework) that relates to 45 Barcom Street site (refer to Figure 1) which is located within the Merrylands West area to guide the future redevelopment of the site.

Where there is inconsistency between this document and provisions contained elsewhere in the Cumberland DCP 2021, the site-specific controls contained in this document shall apply to the extent of the inconsistency.

### 1.2 Land to which this Part applies

This section applies to land at 45 Barcom Street, Merrylands West, containing three (3) lots with a total area of 7.44ha including Lot 5 DP 701151 (2.42ha), Lot 8 DP 732058 (1.928ha) and Lot 11 DP 1075418 (3.092ha) and shown in Figure 1.



Figure 1: Land to which this Part applies

### 1.3 Relationship to Cumberland Development Control Plan 2021

The controls contained in this part are supplementary to and shall be read in conjunction with the following relevant parts of Cumberland DCP 2021.

- Part A - Introduction and General Controls
- Part B - Development in Residential zones
- Part C - Development in Business zones
- Part E - Other land use-based development controls
- Part F1 - Residential site-specific development controls (refer to Sherwood scrubs and adjoining land)
- Part G - Miscellaneous Development Controls (for general heritage conservation, traffic and parking controls, tree management and landscaping and other related controls)
- In addition to this Part, SEPP ((Housing for Seniors or People with a Disability) 2004, SEPP 65 and the NSW Apartment Design Guide (ADGs) must be considered when preparing a development application. Where there is an inconsistency between this DCP Part and provisions contained elsewhere in Cumberland DCP 2021, the provisions of this Part shall prevail.

## 2. Vision and General Objectives

### 2.1 Vision

The Cardinal Gilroy Village is a vibrant and active Seniors Housing development that integrates with, complements and enhances the surrounding Merrylands West community.

### 2.2 General Objectives

#### Objectives

01. Development is predominantly residential in use, making an important contribution to the amount and choice of housing for seniors and people with a disability along with the provision of some related retail and commercial uses for its occupants and the surrounding neighbourhood and broader community. The site will establish a 'landmark' development for Seniors and People with a Disability and deliver a mix of high-quality seniors housing to meet a demonstrated need.
02. Buildings are sited, positioned and designed to maximise climatic responsiveness and provide high levels of desirable solar access and natural ventilation.
03. Development creates a high level of residential amenity, including optimising outlook and views to desirable landscape elements, and respects the amenity of surrounding established residential areas.

- O4. Deliver the highest standards of urban planning and excellence in architectural design.
- O5. Development creates two distinct precincts to the north and south with a green heart (open space) at its core. Central Park will be a publicly accessible, multi-use park that forms the centre piece of new through-site linkages.
- O6. Development provides for a varied, integrated open space network that provides for a diverse range of informal active and passive recreational activities in a largely green, soft landscaped setting and development that provides for considerable area of landscaped open space to reduce urban heat loads.
- O7. Development that provides for considerable area of landscaped open space to reduce urban heat loads and maintain the landscaped character of the locality.
- O8. Create liveable communities by providing high quality amenities and open space to meet the needs of existing and future residents of Merrylands West.
- O9. The establishment of permissible retail/commercial uses at ground level fronting Kenyons Road to enhance convenience and service the day to day needs of occupants and surrounding residents.
- O10. Development responds to and respects the site and its context, including its strategic, transit proximate location, topography and surrounding residential uses and heritage significant surrounds located to the site's west.
- O11. Existing heritage surrounding the site is retained, enhanced and respected through increased building separation distances and setbacks, protection of key view corridors and the provision of landscaped open space within the visual curtilage of the heritage significant items.
- O12. Development provides for a high level of engagement between the public and private domains, in particular providing for pedestrian integration and extensive opportunities for passive casual surveillance.

### **2.3 Master plan**

The vision and principles for the site as identified above are spatially expressed in the urban structure for the precinct as shown in Figure 2.

To ensure that development provides key elements, where variations to the master plan are proposed, the development application is to demonstrate how the vision and principles have been achieved.



Figure 2: Master Plan

## 3. Specific objectives and controls

### 3.1 Land use

#### Objectives

- O1. Development creates a vibrant and active Seniors Housing development that integrates with, complements and enhances the surrounding Merrylands West community.
- O2. Development provides for permissible retail/commercial uses on the ground level fronting Kenyons Road that supports the day to day and lifestyle needs of residents and the surrounding neighbourhood.

#### Controls

- C1. Land use is in accordance with Figure 3.
- C2. Development provides for a maximum of 1,480sqm of GFA of permissible retail/commercial uses. Note: permissible retail/commercial uses include kiosks, neighbourhood shops and health services facilities, etc.
- C3. Permissible retail/commercial uses such as a neighbourhood shop, kiosk and health services facilities are located at ground level fronting the Kenyons Road buildings in accordance with Figure 3.
- C4. The open space areas detailed in Figure 3 are publicly accessible and connected by a network of pedestrian linkages (refer to Section 3.6 below).





Figure 3: Land use

### 3.2 Building Height

- O1. Objectives Building height is varied throughout the site to reflect the scale and density of surrounding development and create an articulated and visually interesting development  
Develop a strong and high-quality network of public open spaces that includes town squares, parks and streets.
- O2. Building height adopts a height pyramid principle with taller buildings located in the centre of the site transitioning to lower rise buildings at the site's edges.
- O3. Building height retains adequate solar access and privacy to neighbouring educational, residential and heritage significant properties throughout the year.

#### Controls

- C1. Maximum building height is generally in accordance with Figure 4.
- C2. Building heights allow solar access to neighbouring properties in accordance with Part B under Cumberland DCP 2021.



Figure 4: Building height (storeys)



### 3.3 Building siting and setbacks

#### Objectives

- O1. Buildings are sited to provide adequate separation between proposed buildings within and adjoining the site, and a physical and landscaped buffer to proposed buildings adjoining (or located outside) especially adjoining residential and heritage significant properties.
- O2. Buildings are sited to provide a high level of amenity within and for adjoining residential and heritage significant properties.

#### Controls

- C1. All residential buildings on the site are setback in accordance with the provisions of Part 3F- I of the Apartment Design Guide (ADG).
- C2. Setbacks for all buildings adjacent to the boundary are in accordance with Figure 5 with indicative sections in Figures 6-8.



Figure 5: Building setbacks

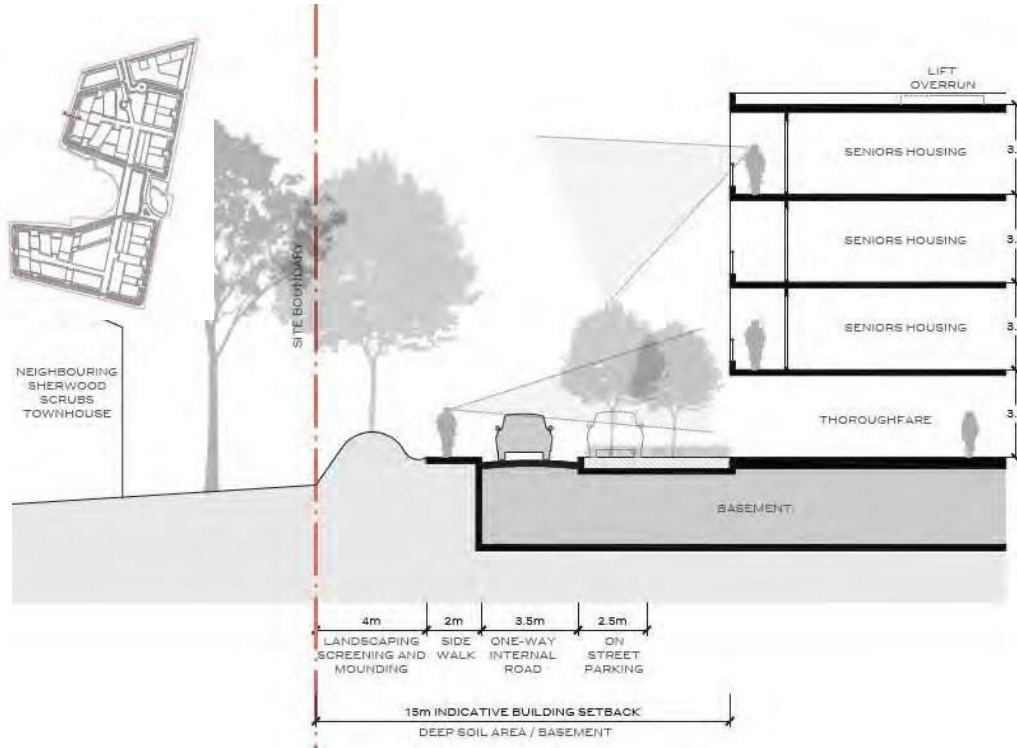

Figure 6: Indicative section from Sherwood Scrubs Townhouses to the west

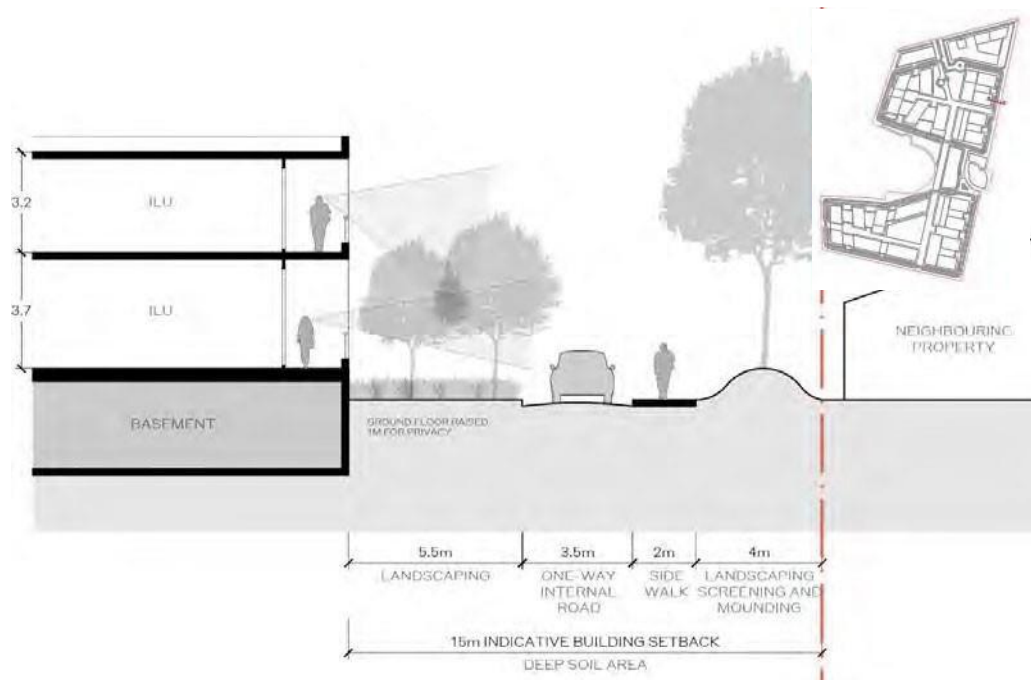

Figure 7: Indicative section adjacent to the residential development to the east

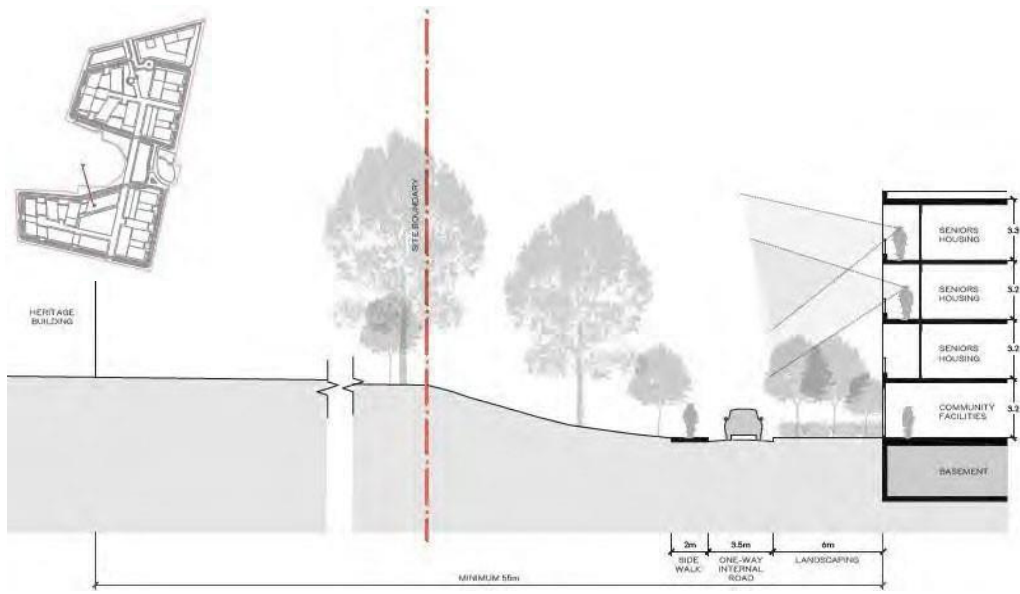

Figure 8: Indicative setbacks from the heritage item to the west



Figure 9: Building separation setbacks

- C3. Building setbacks and separation distances for buildings fronting internal streets and open space areas are to be generally consistent with Figure 9.

- C4. Buildings fronting Kenyons Road are to be setback 10m from the street boundary. Awnings may encroach into the setback area consistent with Figure 10.
- C5. Overlooking to adjoining residential zones is minimised via the use of fixed privacy screens, fixed depth planter boxes or similar where required.
- C6. Buildings are setback to allow direct solar access to neighbouring properties in accordance with Part B under Cumberland DCP 2021.
- C7. Buildings are sited to ensure lines of sight to publicly accessible and communal open space is maximised.

### **3.4 Built form**

#### **Objectives**

- O1. Buildings are designed to activate and engage with the adjoining public domain.
- O2. Buildings are designed to reduce the bulk and scale when viewed from the public domain and provide visual interest and to minimise built form impacts from the site to the adjoining residential and heritage significant properties.
- O3. Internal street setbacks and upper-level setbacks enable sunlight and view corridors, whilst allowing passive surveillance from upper-level balconies and terraces.

#### **Controls**

- C1. Building fronting Kenyons Road are designed to have activated uses at ground level that ensures:
  - the number of individual tenancies that adjoin and are directly accessible from the public domain are maximised;
  - multiple accessible pedestrian entries are provided from the public domain;
  - large areas of transparent glazing or other openings enable clear sightlines between the public domain and internal areas, in particular those with high levels of activity;
  - any kiosk uses may include outdoor seating fronting Kenyons Road;
  - awnings or other overhangs provide shelter for outdoor seating areas and minimise noise transmission to dwellings above; and
  - roller shutters or bars are not permitted on windows or openings fronting the public domain.

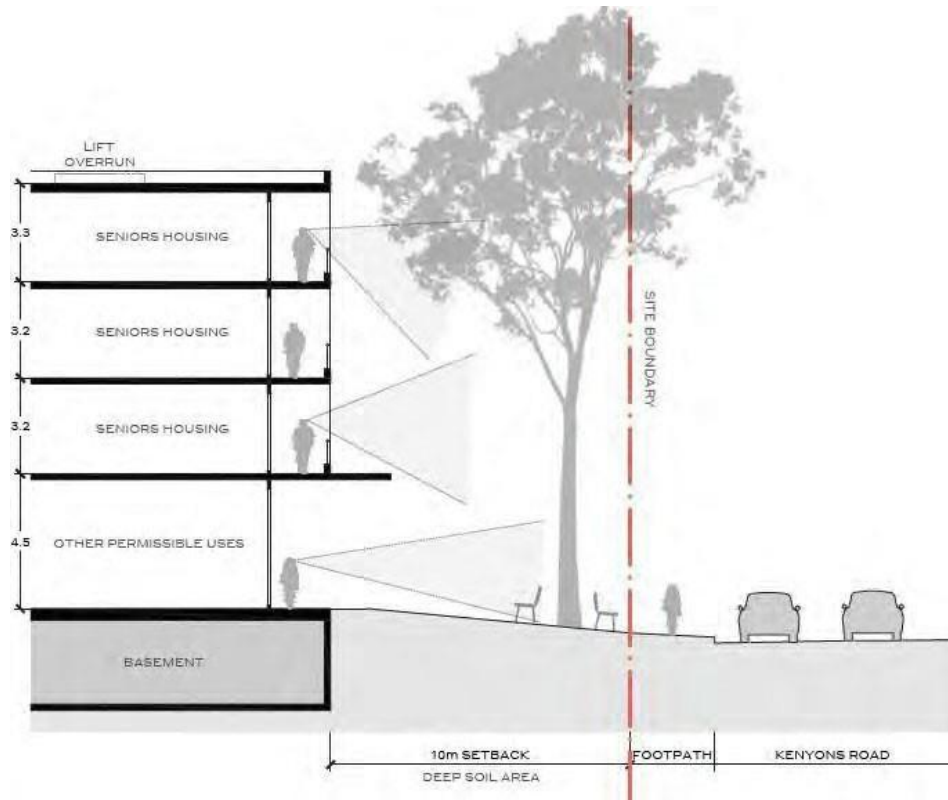

Figure 10: Indicative section for buildings fronting Kenyons Road

- C2. Loading docks and any vehicular access points are not be located fronting the public domain and are to be unobtrusively located to minimise the visual impact.
- C3. Upper-level residential dwellings are designed to have their main living areas and adjoining private open space oriented to and directly overlook the public domain, internal roads or publicly accessible open space areas in accordance with Figure 11.

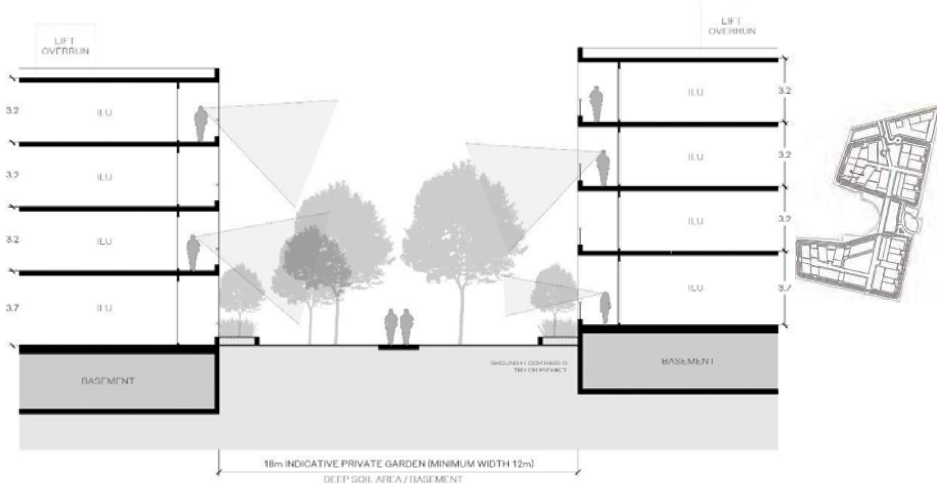

Figure 11: Indicative section for buildings

- C4. Building designs are to follow the topography of the land and minimise the cut and fill of the site.



- C5. Floor to ceiling heights are provided in accordance with the ADG.
- C6. Building facades are positioned to optimise solar access to main internal living areas and adjoining private open space and optimise outlook and views to high amenity features such as open space.
- C7. Blank walls are to be avoided and building facades feature articulation using design measures such as:
- recessed and/or projecting balconies
  - blades or fins
  - privacy screens
  - large windows and other openings
  - sun control devices such as eaves, louvres and screens
  - differentiation of materials
  - architectural features.
- C8. Maximum depth and width is in accordance with the ADG.
- C9. New development adjacent to the heritage building requires consideration of building materials that are complementary to the retained heritage buildings, sympathetically designed and supported by a Heritage Impact Statement.
- C10. View corridors to the adjacent heritage building are maximised through the publicly accessible central park from the Barcom Street entrance and community centre.
- C11. Building facades are designed to provide a variety of design solutions, to promote diversity, choice and character of space.

### **3.5 Open space and landscaping**

#### **Objectives**

- O1. To provide for open space includes a variety of publicly accessible parks, communal open space and through-site links for the benefit of the surrounding Merrylands West community.
- O2. To provide for publicly accessible and communal open space that caters for a diverse range of informal passive and active recreation activities that are accessible, useable, permeable and fit for their intended purpose.
- O3. To provide for publicly accessible and communal open spaces that have a high level of amenity, including adequate solar access throughout the year, shade during the summer, circulation and safety.
- O4. To provide for publicly accessible and communal open spaces that have a coherent, legible landscape character, and offers a high level of visual amenity.
- O5. To enhance the surrounding and internal pedestrian and street networks with quality landscaping and architectural responses, to facilitate a network of green links.

- O6. To promote social cohesion and a sense of community through providing spaces that cater for organised and informal community gathering and interaction.
- O7. To respect the existing natural assets such as existing significant trees and other planting to create attractive spaces and encourages biodiversity.

### **Controls**

- C1. Development is to provide a publicly accessible central park (open space) area having a minimum area of 5,000sqm located centrally on the site that forms the green heart of the Cardinal Gilroy Village. Indicative sections of the publicly accessible central park are provided in Figure 13.
- C2. All publicly accessible and communal open space areas include the following:
  - soft and hard landscaping for passive recreation and active play;
  - sufficient area for deep soil planting to support large, spreading canopy trees
  - adaptable playground areas; and
  - amenities such as BBQ facilities, shade structures, seating, lighting, bins and signage.
- C3. Open spaces are designed to create a variety of type of space (path, street, square, park) character of space (public, recreational, semi-private) and scale of space, that responds to the characteristics of all proposed areas and landscaping in accordance with Figure 12.
- C4. Development provides for continuous linear through-site links between building that provide a physical and visual connection between the publicly accessible central park and surrounding properties.
- C5. Ground level communal open space area for occupants are to be provided for the northern and southern precincts with a direct visual connection to the publicly accessible central park and green spaces where possible. All publicly accessible and communal open space is to be designed in accordance with CPTED principles.
- C6. Where possible, publicly accessible and communal open space includes areas for community gardens in locations that do not compromise the useability of the space for informal active and passive recreation activities.
- C7. A minimum of 4 hours of direct solar access is to be maintained to at least 50% of the publicly accessible central park on June 21 between 10.00am and 3.00pm.
- C8. A minimum of 2 hours of direct solar access is to be maintained to at least 50% of the communal opens space areas on June 21 between 10.00am and 3.00pm.
- C9. Open space is provided generally in accordance with Figure 12. Indicative sections of the publicly accessible central park are provided in Figure 13.





Figure 12: Open space network and linkages

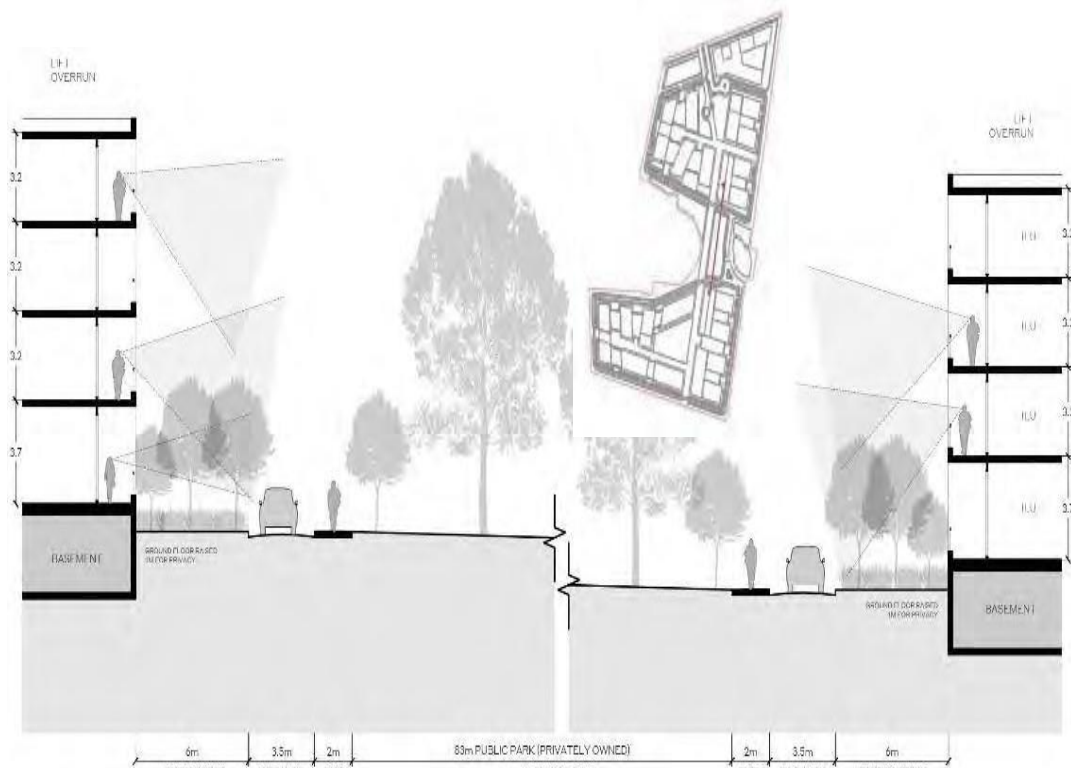

Figure 13: Indicative section of buildings overlooking public and private open space

- C10. Existing significant trees around the perimeter of the site, in particular those that provide a screening function for adjoining uses are retained where not required for site access points or internal roads and are integrated into the prevailing landscape character of the precinct.
- C11. A minimum of 25% of the site area is to comprise of deep soil landscaped area.
- C12. A minimum of 50% of the front setback area to Kenyons Road is to comprise of deep soil landscaped areas.
- C13. Deep soil landscape areas are located between buildings and between the residential boundaries surrounding the site. The deep soil landscaped areas on the boundaries are to contain a combination of mounding and/or dense landscaping to provide amenity and maximise screening between properties.
- C14. Plantings in open space areas incorporate a diverse selection of locally native species including trees, shrubs and grasses/groundcovers.

### 3.6 Movement network

#### Objectives

- O1. The movement network provides for multiple points of public access to the precinct.

- O2. The movement network is functional and provides for the efficient, safe and comfortable movement of vehicles, pedestrians and cyclists.
- O3. The movement network where appropriate, provides opportunities for social interaction and gathering.

**Controls**

- C1. Vehicular movement and directions are provided in accordance with Figure 14. Limited on-street parking is provided for pick up and drop off zones for residents and their guests adjacent to building entries.
- C2. The vehicular and pedestrian access points from the public domain are provided on Kenyons Road and Barcom Street in accordance with Figure 14.

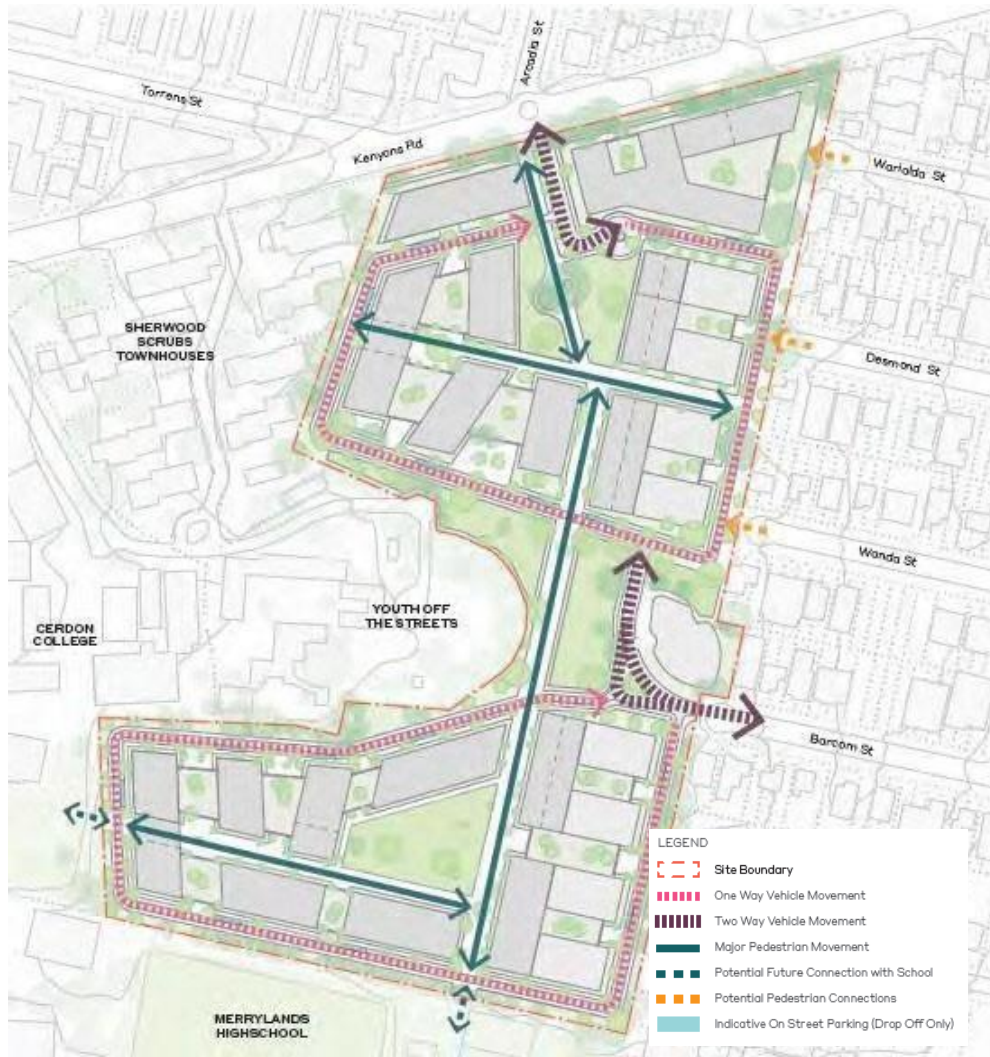

Figure 14: Movement Plan

- C3. All internal streets around the periphery of the site are to:
  - be single land to a maximum width of 3.5 metres;

- limited on-street parking is provided for pickup and drop off zones for residents and their guests adjacent to building entries;
- include pedestrian paths and landscaping;
- prioritise pedestrian and cyclist movement over vehicular movement; and
- include a landscaped verge on both sides with extensive and co-ordinated tree plantings and be generally in accordance with the indicative sections in Figures 15 and 16.

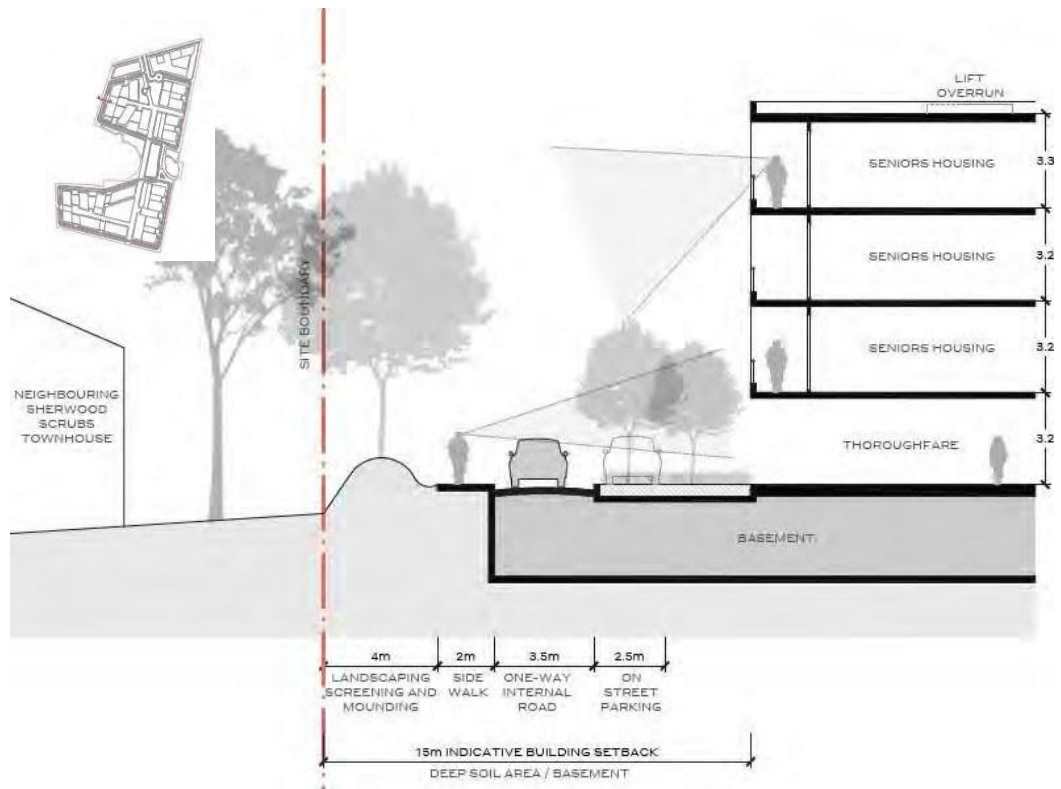

Figure 15: Indicative western section



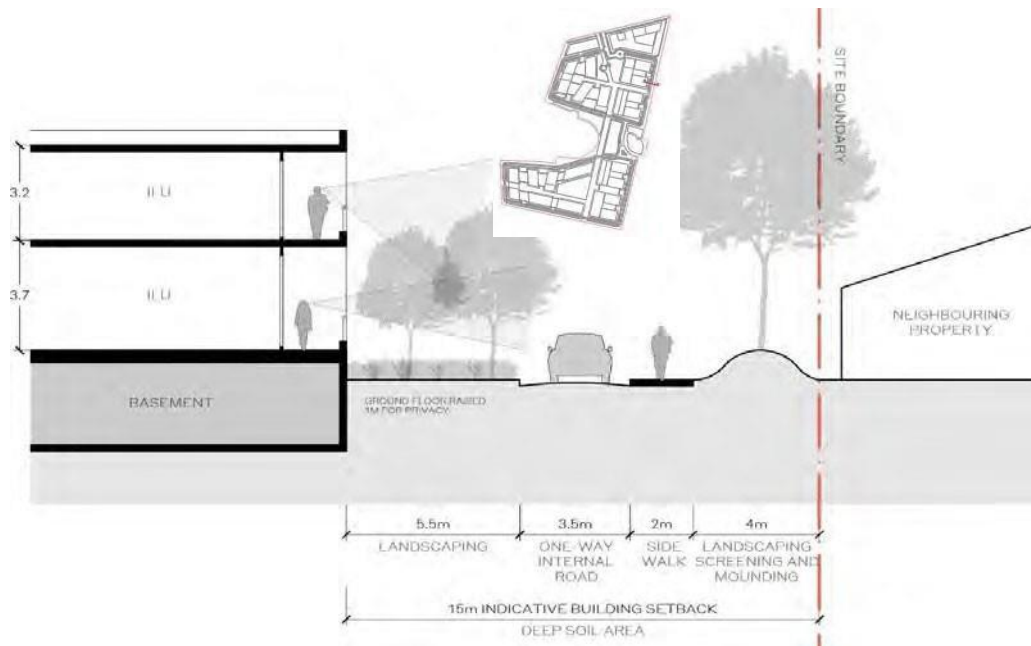

Figure 16: Indicative western section

C4. The pedestrian and cycle access network:

- is direct, accessible and easily identified by all users;
- includes signage for way-finding and advising of the publicly accessible status of the link and the places to which it connects;
- is integrated into the network design and includes furniture, facilities and materials of a high quality
- is well lit and open to the sky for the entire length
- is clearly distinguished from vehicle access-ways
- allows visibility along the length of the through-site links.

C5. Street furniture is provided and includes a high quality, durable and co-ordinated selection of:

- paving;
- seating;
- lighting;
- rubbish bins; and
- signage.

- C6. Provision is made to allow possible future connections from the site to adjoining properties to the east, west and south in accordance with Figure 14.
- C7. Street trees are to be provided on all streets and pedestrian links that:
- comprise a co-ordinated palette of climatically responsive species;
  - are robust and low-maintenance;
  - are planted in a co-ordinated and formalised manner;
  - increase the comfort of the public domain for pedestrians, including through the provision of shade in summer; and
  - enhance the environmental performance of the precinct by increasing opportunities for energy conservation.

### **3.7 Managing transport demand and parking**

#### **Objectives**

- O1. The movement network provides for multiple points of public access to the precinct.
- O2. On- site car parking is provided at a rate that balances the needs to provide for the convenience needs of residents and visitors while encouraging more sustainable forms of movement such as public transport, walking and cycling.
- O3. On-site car parking is provided in a form that reduces overall building size and enables the creation of a positive relationship between building and the adjoining public domain, through high levels of integration at the ground floor level.

#### **Controls**

- C1. All development applications are to include a 'Transport and Traffic Impact Assessment Study' addressing the potential impact of the development on surrounding movement systems, where the proposed development comprises:
- Retail/commercial development of more than 1,000m<sup>2</sup> Gross Floor Area;
  - residential development of 100 or more new dwellings; or
  - likely to generate significant traffic impacts according to the consent authority.
- C2. Any development application is to include a site wide 'Green Travel Plan' to outline initiatives for walking, cycling and the use of public transport. The Green Travel Plan should address different transport needs and patterns for residential and retail/commercial uses.
- C3. Any development application is to include a 'Transport Access Guide', and a strategy for its future availability to residents, employees and visitors, to the Seniors Housing development.
- C4. End-of-trip facilities including showers and lockers must be provided to adequately service the number of bicycle parking spaces required for employees in the retail/commercial uses and are to be located close to the bicycle parking area, entry/exit

points, and within an area of security camera surveillance preferably where there are such building security systems.

- C5. On-site car parking is provided in accordance with Part G, Cumberland DCP 2021 and the State Environmental Planning Policy (Housing for Seniors of People with a Disability) 2004.
- C6. All on-site car parking is provided within basements where the basement only protrudes a maximum of 1 metre above ground level. Limited on-street parking is provided for pickup and drop off zones for residents and their guests adjacent to building entries.

### **3.8 Environmental performance**

#### **Objectives**

- O1. To reduce environmental impact over the life cycle of a building.
- O2. On- site car parking is provided at a rate that balances the needs to provide for the convenience needs of residents and visitors while encouraging more sustainable forms of movement such as public transport, walking and cycling.
- O3. To enhance local biodiversity through the planting of diverse native plant species.
- O4. To promote renewable energy initiatives.
- O5. To reduce urban heat island effect by providing shading trees, vegetation and selection of materials that deflect radiation from the sun.

#### **Controls**

- C1. Ensure rainwater is captured, stored and used for non-potable uses such as irrigation of landscaping.
- C2. To reduce the necessity for mechanical heating and cooling.
- C3. To enhance local biodiversity through the planting of diverse native plant species.
- C4. Consideration should be given to utilising roof space for developing roof gardens (green roof).
- C5. Where appropriate bio-walls (green walls) should be incorporated in the design of buildings.
- C6. Selection of sustainable materials should be considered as part of the future development, with a relatively positive impact on communities and the environment.
- C7. During demolition of existing structures, recycling or reuse of resources and waste management approaches should also be considered throughout development stages.
- C8. Materials should provide optimal insulation and address the reduction of urban heat island effect.



*This page has been left intentionally blank*



CUMBERLAND  
CITY COUNCIL

**PART F1-18  
DUNMORE STREET,  
PENDLE HILL (FRESH  
HOPE CARE SITE)**

# 1. Introduction

## 1.1 Land to which this section applies

This section applies to the following land (as shown in **Figure 1** below):

Address	Lot and DP
284 Dunmore Street, Pendle Hill	Lot 1 DP24728
105 Pendle Way, Pendle Hill	Lot 2 DP24728
93 Pendle Way, Pendle Hill	Lot 8 DP24728
91 Pendle Way, Pendle Hill	Lot 9 DP24728
87 Pendle Way, Pendle Hill	Lot 10 DP24728
85 Pendle Way, Pendle Hill	Lot 11 DP24728
83 Pendle Way, Pendle Hill	Lot 12 DP24728
282 Dunmore Street & 95 Pendle Way, Pendle Hill	Lot 472 DP1204429
268-280 Dunmore Street, Pendle Hill	Lot A DP335578
222-266 & 282 Dunmore Street & 89 Pendle Way, Pendle Hill	Lot 2 DP554208
222-266 Dunmore Street, Pendle Hill	Lot 3 DP554208



Figure 1: Land to which this section applies

## 2 Vision and general objectives

### 2.1 Vision

The Dunmore Street site is a high-quality residential precinct that respects and celebrates its history and integrates with and enhances the surrounding Pendle Hill area.

The site will play an important role in contributing to additional supply for seniors housing and affordable key worker housing, capitalising on its proximity to the Pendle Hill local centre, the adjacent Bonds Spinning Mills site and Pendle Hill railway station.

The site provides a high-amenity landscaped setting, including an open space curtilage to the heritage listed Dunmore House, new opportunities for publicly accessible open space and community uses for the local population.

### 2.2 General objectives

- O1. Development responds to the natural and built form elements of the site, the surrounding local character, the existing orthogonal street grid, heritage items and evolving built form scale, including the adjacent Bonds Spinning Mills site.
- O2. Development is predominantly for seniors housing and affordable key worker housing, significantly contributing to housing choice and affordability in the Cumberland LGA.
- O3. Celebrate and give precedence to the heritage components of the site while maintaining a heritage curtilage around Dunmore House, which is also a key determining feature in the open space network and landscaped character of the site.
- O4. New buildings adjacent to heritage items will respect the site's heritage through appropriate setbacks and design.
- O5. Development is well designed and effectively transitions to development on adjoining sites through building heights, massing, setbacks and landscaping.
- O6. Development on the corner of Dunmore Street and Pendle Way will be of a height, scale and design that provides a built form marker when approaching the site from the Pendle Hill local centre and railway station.
- O7. Existing mature vegetation on the site is retained and complemented through new planting of native species and landscaping.
- O8. The site will contain a legible and permeable movement network for pedestrians and cyclists, including potential linkages to the adjoining Bonds Spinning Mills site.
- O9. The site will provide an extensive open space network comprised of private and public open spaces, including the publicly accessible open space curtilage to Dunmore House.



### 2.3 Indicative Master plan

The vision and objectives for the site as identified above are expressed in the structural design for the site as shown in **Figure 2**.

To ensure that development provides key elements, where variations to the Indicative Master Plan are proposed, the relevant development application (DA) is to demonstrate how the vision and objectives have been achieved.



Figure 2: Indicative Master Plan

## 3 Specific objectives and controls

### 3.1 Land use

#### Objectives

- O1. Create a high-quality residential precinct, primarily consisting of seniors and affordable key worker housing.
- O2. Provide an extensive open space network, including a centrally located publicly accessible recreational and community space in the Dunmore House curtilage, for new residents and the local community.
- O3. Provide for associated ancillary uses to meet the daily convenience and recreational needs of onsite residents and workers.

#### Controls

- C1. Land uses are to predominantly comprise residential development, specifically seniors housing and affordable key worker housing.
- C2. Non-residential uses are to generally include:
  - a. allied health services
  - b. publicly accessible recreational and community uses
  - c. places of public worship
  - d. café/s
- C3. Non-residential uses permissible in the R4 High Density Residential zone, such as cafes and neighbourhood shops, are to be located at ground level to maximise accessibility and contribute to the activation of streets.

### 3.2 Building height

#### Objectives

- O1. Provide opportunities for increased height and density to support the future provision of seniors housing and affordable key worker housing on the site.
- O2. Ensure building heights respond to the existing and future built form character of the area, including the adjoining Bonds Spinning Mills site and lower density residential developments surrounding the site.
- O3. Minimise any adverse shadow impacts to open spaces within the site and adjoining residences.
- O4. Maintain 'finer-grained' proportions along the southern boundary to respond to existing lower density residential development on Collins Street.

#### Controls

- C4. Maximum building heights to be generally in accordance with **Figure 3: Building heights**
- C5. Reduced level details must be in accordance with Part G Cumberland DCP 2021.



Figure 3: Building heights

### 3.3 Building siting and setbacks

#### Objectives

- O1. Provide appropriate separation distances between future buildings on the site in order to maximise amenity for future residents.
- O2. Achieve an appropriate built form scale along Dunmore Street and Pendle Way that contributes to the prevailing streetscape and the existing and future character of the locality.
- O3. Buildings are sited to respect and complement the existing heritage items on the site.
- O4. Buildings are sited to frame new streets and pedestrian links within the site and to maintain view corridors to and from the site.
- O5. Maintain high levels of visual and acoustic amenity and minimise overshadowing of surrounding areas, including the lower density detached dwellings along the site's southern boundary on Collins Street.

#### Controls

- C1. Building setbacks and building separations should generally comply with **Figure 4** to **Figure 7**, including:
  - Minimum setback of 6m to Pendle Way
  - Minimum setback of 6m to Dunmore Street
  - Minimum setback of 6m for first and second storey and a minimum 8m setback for third storey to the southern boundary with existing residences on Collins Street



- Minimum setback of 10m to the southern boundary on eastern part of the site.
- Minimum setback of 10m to the eastern boundary
- Minimum 12m primary separation distance between all new buildings on the site
- Minimum 12m separation distance between Ashwood House and any new building to the immediate south and additional secondary setback of 23m towards the centre of the building.



Figure 4: Setbacks plan

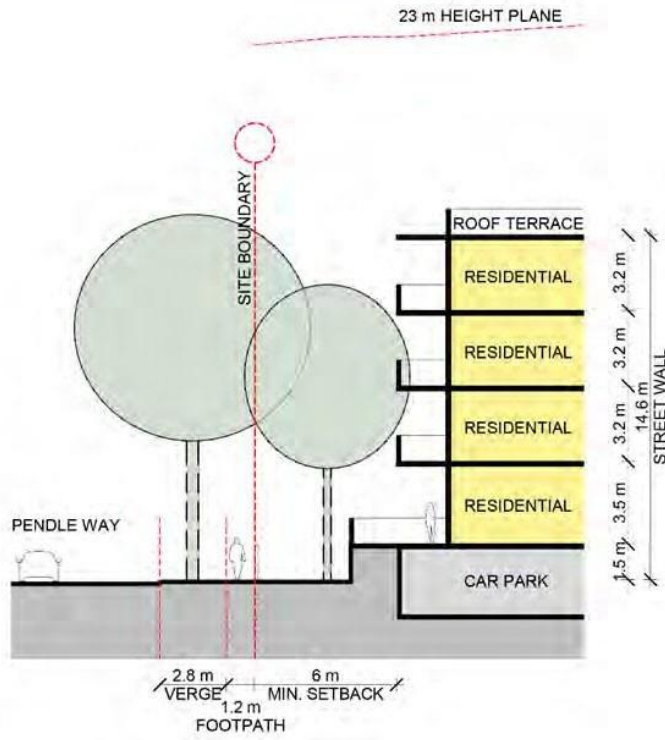

Figure 5: Street setback – Pendle Way

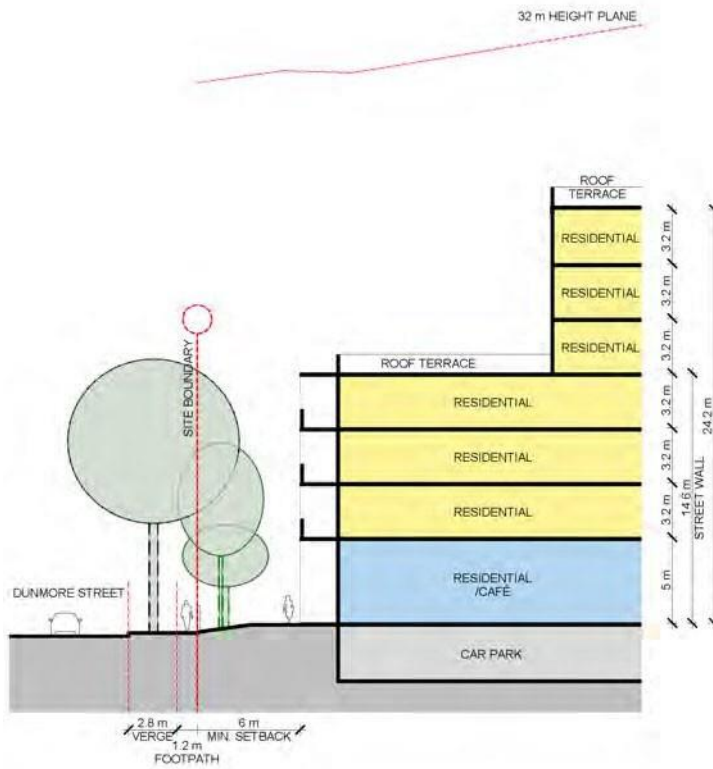

Figure 6: Street setback - Dunmore Street

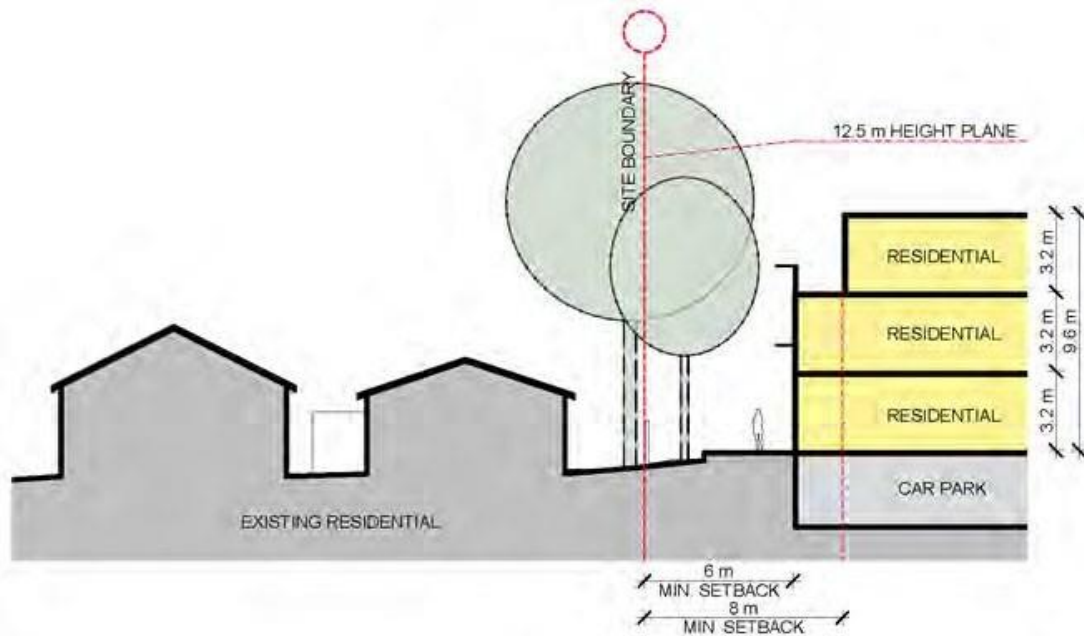

Figure 7: Southern boundary setback

### 3.4 Built form and building design

#### Objectives

- O4. Buildings are designed to complement existing streetscapes and to address and engage with the adjoining public domain.
- O5. Buildings are designed to provide a high level of architectural quality and visual interest and are of an appropriate bulk and scale when viewed from the public domain and surrounding residential areas.

#### Controls

- C1. Building facades along Dunmore Street and Pendle Way street-walls are to incorporate a number of smaller parts through significant recesses, other facade modulation and distinct building elements and materials.
- C2. In relation to residential uses at ground level:
  - the number of individual dwelling entries from the adjoining public domain are maximised
  - where entries provide access to more than one dwelling, they relate to each lift core, are clearly defined and legible and preferably form an architectural feature of the building
  - front boundary treatments use measures such as level changes, landscaping and fencing to provide privacy for residents whilst also providing for casual passive surveillance of the adjoining public domain
  - internal living areas are integrated with areas of outdoor private open space to provide a transition between the public and private domains

- C3. In relation to non-residential uses at ground level:
- pedestrian entries are at the same level as the adjoining public domain
  - cafes or restaurants can have outdoor seating in the adjoining public domain
  - universal access is provided
- C4. Buildings located on corner sites to be articulated to address each street frontage and to define prominent corners.
- C5. The building on the Dunmore Street-Pendle Way corner is to provide a built form marker through a height of 5 storeys and the expression of architectural elements such as building articulation, material, colour and roof form.

### **3.5 Solar access and overshadowing**

#### **Objectives**

- O6. Minimise overshadowing impacts to surrounding public domain and private developments.
- O7. Provide reasonable amount of solar access to new public open spaces within the site.

#### **Controls**

- C1. Provide a minimum of 2 hours of solar access to the publicly accessible open space zoned RE2 Private Recreation between 9am and 3pm in mid-winter.

### **3.6 Open space and landscaping**

#### **Objectives**

- O1. Provide a series of generous publicly accessible open spaces for recreational uses, improving the quality of the public domain and connectivity with surrounding open spaces.
- O2. Retain and enhance the landscaped setting of both Ashwood House and Dunmore House.
- O3. Provide sufficient private communal open space and rooftop gardens to cater for passive and active recreation opportunities for future residents.
- O4. Provide high quality landscaping around the perimeter of the site to enhance the streetscape and quality of the built environment.
- O5. Mitigate any visual impacts of buildings to the south of Ashwood House through provision of soft landscaping.

#### **Controls**

- C6. Open space and deep soil zone should generally be provided in accordance with **Figure 8**.
- C7. Provide a central north-south landscaped publicly accessible open space from Dunmore Street to the site's southern boundary at the rear of Dunmore House. This publicly accessible open space area is to include the following facilities:
- soft and hard landscaping for passive and active recreation

- amenities such as BBQ facilities, shade structures, seating, lighting, bins, playgrounds, community gardens and signage
- C8. Provide publicly accessible pocket parks with varied landscape features within the clusters of buildings connecting to the publicly accessible open space.
- C9. Provide private communal open spaces at the ground level and rooftop areas with a variety of facilities including seating, BBQ facilities and shelters.
- C10. Ground level courtyards are to be provided for ground level Independent Living Units as per the ADG.
- C11. Provide a landscape buffer zone (south of Ashwood House) for the provision of tall screening trees.
- C12. Provide high quality evergreen trees and screening within the setbacks along the site's boundaries as shown in **Figure 1: Setbacks plan**. This is to be achieved by providing a 6m deep soil zone along Pendle Way, Dunmore Street and the southern boundary of the precinct, and a minimum of 10m deep soil zone along the eastern boundary of the precinct.



Figure 8: Open space network

### 3.7 Movement network

#### Objectives

- O1. Improve the site's accessibility and strengthen its connection to surrounding areas.
- O2. Provide a functional movement network that provides for the efficient and safe movement of all road users.
- O3. Encourage walking and cycling through the provision of a comfortable and attractive environment.
- O4. Provide a number of residential access points to activate street frontages and internal private and publicly accessible open spaces and to provide passive surveillance opportunities.
- O5. Reduce traffic impacts to Pendle Way and Dunmore Street and improve the public domain for pedestrians.

#### Controls

- C1. The street network, pedestrian network, site access and car access points are provided generally in accordance with **Figure 5: Public and pedestrian links**.
- C2. The site will incorporate 4 new two-way private roads that will intersect with the adjacent local roads (Dunmore Street and Pendle Way). The new private roads are to be located more than 40 metres (centre to centre) from the nearest intersections on the opposite side of the road.
- C3. Vehicular access points to buildings are to be provided within building footprints. If access is not within the building, high quality landscape and driveway design are to be incorporated to ensure a landscaped streetscape and to mitigate potential visual and acoustic privacy issues for residents.
- C4. Provide new pedestrian access points along both Pendle Way and Dunmore Street.
- C5. Provide a minimum of 4 new publicly accessible through-site links connecting the precinct to the surrounding area, including the Pendle Hill local centre, Pendle Hill railway station and the Bonds Spinning Mills site.
- C6. Streets include pedestrian paths on each side.
- C7. Pedestrian footpaths on new roads are separated with a planting strip which is at least 1.8m in width.
- C8. Private pedestrian links are interconnected with the new publicly accessible links.
- C9. The pedestrian and cycle access network:
  - Is direct and accessible to all
  - is easily identified by users
  - has a public character
  - includes signage advising of the publicly accessible status of the link and the places to which it connects
  - is clearly distinguished from vehicle access-ways
  - allows visibility along the length of the link to the public domain at each end.



- C10. Strong, legible pedestrian connections are established between the site and adjoining areas.
- C11. The pedestrian and cycle access network:
- aligns with breaks between buildings so that views are extended and the sense of enclosure is minimised;
  - includes materials and finishes (paving materials, tree planting, furniture etc.) integrated with adjoining streets and public spaces and be graffiti and vandalism resistant;
  - is well-lit to safety standards;
  - is open to the sky along the entire length; and
  - is accessible 24 hours a day.
- C12. Street furniture is provided and includes a high quality, durable and co-ordinated selection of paving, seating, lighting, rubbish bins, playground equipment and signage.
- C13. Street trees are to be provided within deep soil zones on all streets that:
- comprise a co-ordinated palette of climatically responsive species
  - are robust and low-maintenance
  - are planted in a co-ordinated, regularly spaced and formalised manner
  - increase the comfort of the public domain for pedestrians, including through the provision of shade in summer
  - enhance the environmental performance of the precinct by increasing opportunities for energy conservation.
- C14. In areas where deep soil zones cannot be achieved, suitable trees species will:
- comprise a co-ordinated palette of climatically responsive species
  - are robust and low-maintenance
  - provide adequate canopy shade, for the comfort of pedestrians.
- C15. On-site car parking is provided in accordance with Part G, Cumberland DCP 2020.
- C16. Carpark access is co-ordinated to provide for efficiency and convenience while not adversely affecting the pedestrian movement or the visual amenity of the public domain.



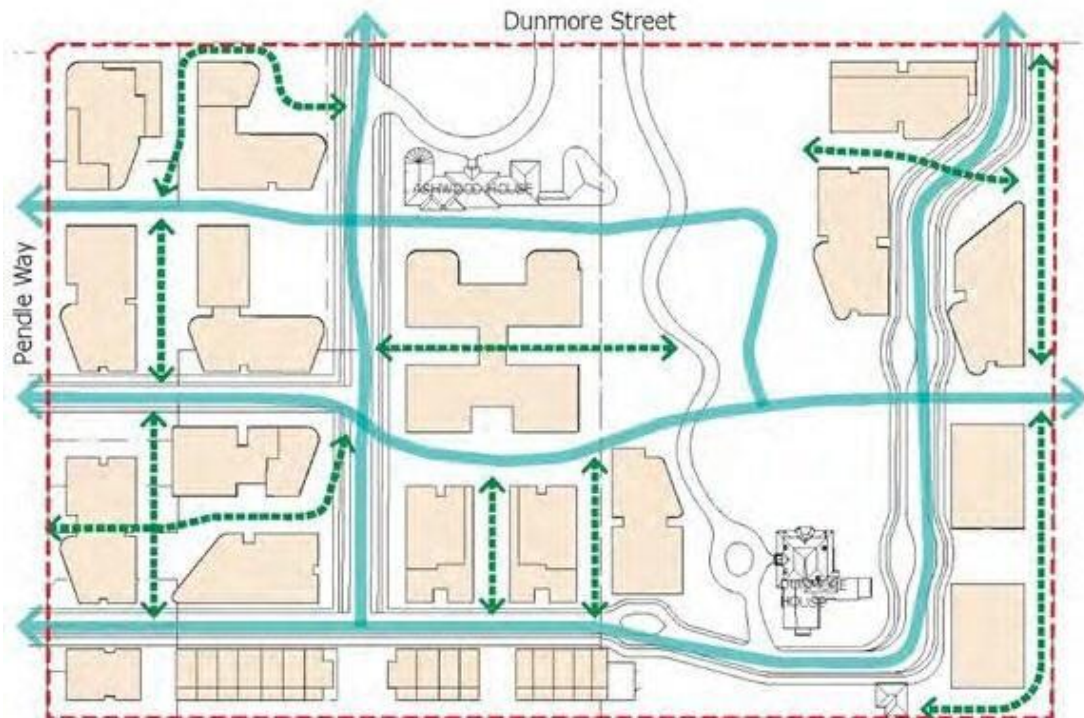

Figure 9: Public and pedestrian links



### 3.8 Managing transport demand

#### Objective

- O1. Ensure that the transport demand generated by development is sustainably managed.

#### Controls

- C1. DAs are to include a Transport Impact Assessment addressing potential impacts of development on the surrounding transport network, where the proposed residential development comprises 100 or more new dwellings.
- C2. Car parking spaces are to be provided in accordance with *State Environmental Planning Policy (Housing for Seniors or People with a Disability) 2004*, Australian Standard/ New Zealand Standard, Parking Facilities, Part 6: Off -Street Parking for People with Disabilities AS/NZS 2890.6:2009 and Part G3 Cumberland DCP 2021.
- C3. Bicycle parking spaces are to be provided in accordance with Part G3 Cumberland DCP 2021.
- C4. One ambulance space to be provided as required for the Residential Aged Care facility.

### 3.9 Heritage

#### Objectives

- O1. Development respects and celebrates the site's heritage significance.

- O2. Development seeks to identify the potential for archaeological remains and ensures adequate protection and best-practice management of remains or relics.
- O3. Retain primary views to and from Dunmore House from Dunmore Street.

**Controls**

- C1. Heritage curtilage is to be provided as shown in **Figure 6: Heritage Curtilage**.
- C2. Buildings are set back from Dunmore House in accordance with **Figures 11 and 12**
- C3. Minimum 12m separation distance between Ashwood House and any new building to the immediate south and additional secondary setback of 23m towards the centre of the building, inclusive of a landscape buffer zone for the provision of tall screening trees.
- C4. Development is sited and designed generally in accordance with the Dunmore House & Ashwood House Conservation Management Plan (CMP) prepared by Weir Phillips Heritage and Planning (September 2019).
- C5. Dunmore House and Ashwood House are sympathetically restored and adaptively re-used and integrated with the remainder of the site. This includes adaptive reuse of and public access to Dunmore House for community use.

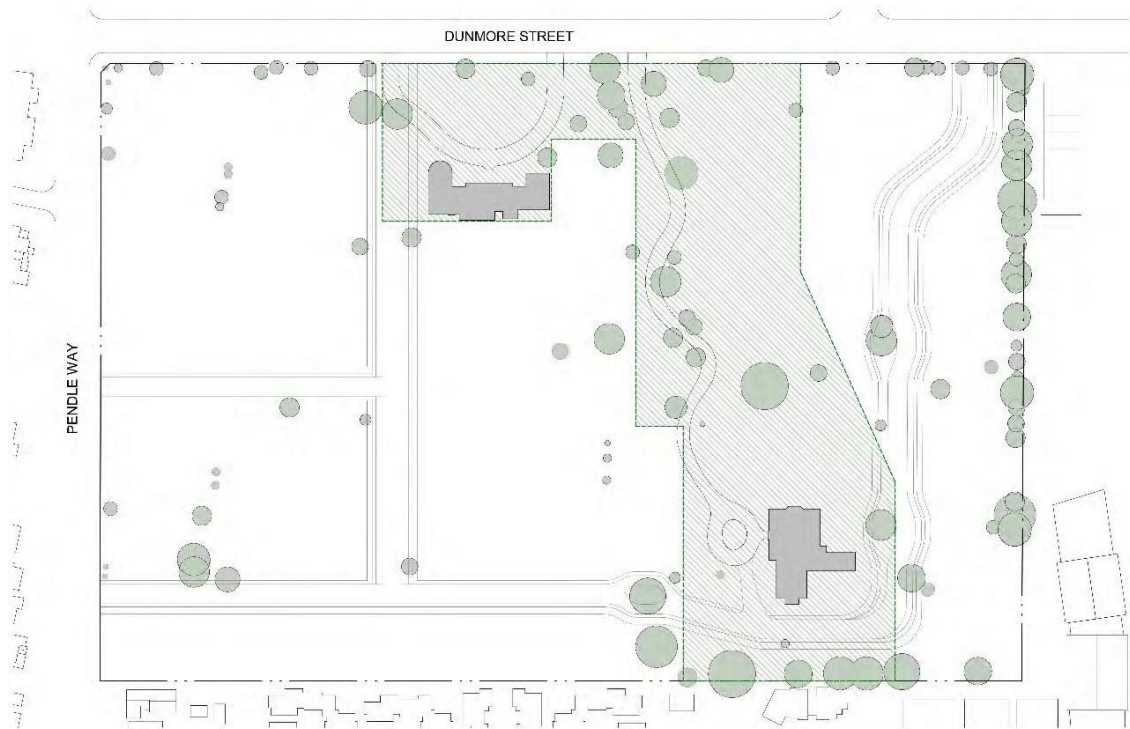

Figure 10: Heritage Curtilage

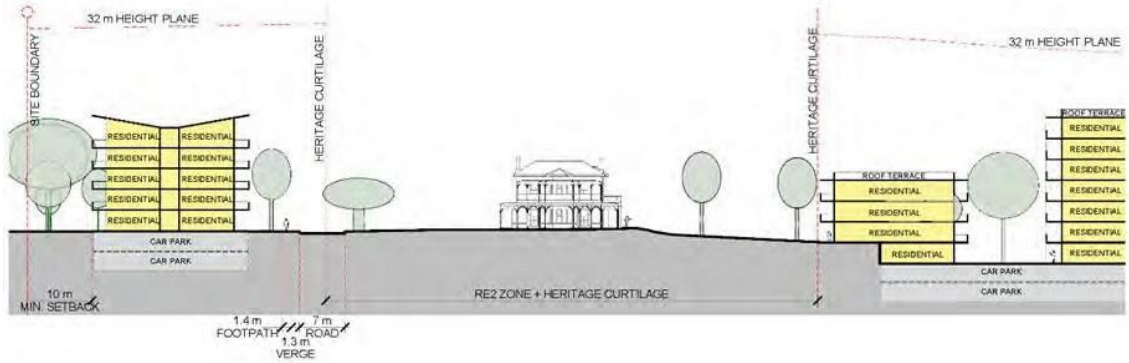

Figure 11: Heritage curtilage setback

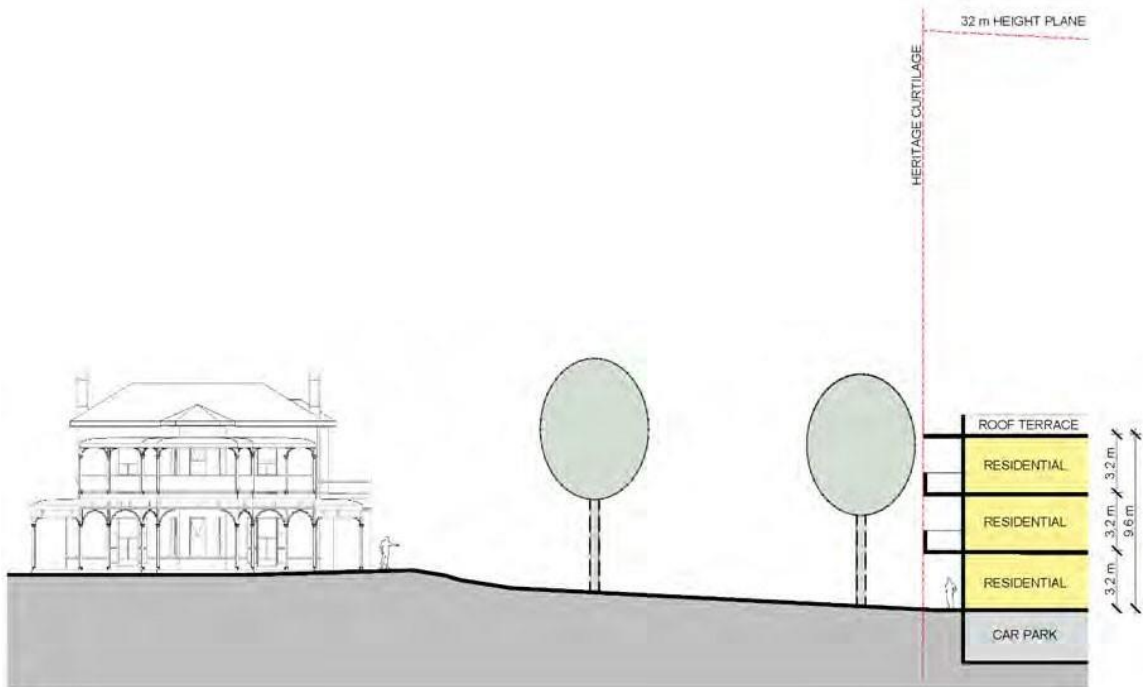

Figure 12: Dunmore House setback

*This page has been left intentionally blank*



CUMBERLAND  
CITY COUNCIL

# PART F1-19

80 BETTY CUTHBERT  
DRIVE, LIDCOMBE



# 1. Introduction

## 1.1 Purpose of this DCP

The purpose of this Development Control Plan ('DCP') is to outline the 'site specific controls' (the detailed planning and design framework) that relates to 80 Betty Cuthbert Drive (refer to **Figure 1**) which is located south of the Lidcombe town centre. Where there is inconsistency between this document and provisions contained elsewhere in the Cumberland Development Control Plan 2021, the site-specific controls contained in this document shall apply to the extent of the inconsistency.

## 1.2 Land to which this Part applies

This section applies to the site referred to as 80 Betty Cuthbert Drive, containing the following three (3) lots – Lots 74 and 75 in DP 1141724 and Lot 475 in DP 45747. The site has a total area of approximately 58,818 sqm.

Figure 1 Site Aerial



## 1.3 Relationship to Cumberland Development Control Plan 2021

The controls contained in this part are supplementary to and shall be read in conjunction with the following relevant parts of Cumberland DCP 2021.

- Part A – Introduction and General Controls
- Part B – Development in Residential zones
- Part C – Development in Business zones

- Part E – Other land use-based development controls
- Part G - Miscellaneous Development Controls

Where there is an inconsistency between this DCP Part and provisions contained elsewhere in Cumberland DCP 2021, the provisions of this Part shall prevail.

## 2 Vision and general objectives

### 2.1 Vision

Provide a mix of residential, educational and health services within a landscaped setting to complement and enhance the Lidcombe area.

### 2.2 General objectives

- O1. Assist in creating a 30-minute city where residents are close to jobs, education, health facilities and other services.
- O2. Exemplify a thriving community where residents live in healthy and highly connected neighbourhood served by well-maintained public spaces and facilities.
- O3. Facilitate the opportunity for residents to choose from a variety of housing choices to range of income levels and lifestyles.
- O4. Provide a highly connected, safe and permeable network with convenient access to public transport, public spaces and facilities, and amenities.
- O5. Provide opportunities to extend the pedestrian and cycle routes beyond the site.
- O6. Celebrate the natural environment through conservation of important trees and maintain the existing landscaped character of surrounding residential areas.
- O7. Prioritise healthy living, including design to mitigate and adapt to heat, and design for active transport.
- O8. Buildings are sited, positioned and designed to maximise climatic responsiveness and provide high levels of desirable solar access and natural ventilation.

### 2.3 Indicative Master Plan

The vision and principles for the site as identified above are spatially expressed in the urban structure for the precinct as shown in **Figure 2**. To ensure that development provides key elements, where variations to the master plan are proposed, the development application is to demonstrate how the vision and principles have been achieved.



Figure 2: Indicative Master Plan



### 3 Specific objectives and controls

#### 3.1 Land use

##### Objectives

- O1. Educational Establishment - Providing a future educational establishment on an existing government site to meet the current educational demands of the Lidcombe area and surrounding areas.
- O2. MSL Health Facility - Provide a fit for purpose facility for the care, support and treatment for multiple sclerosis and other neurological conditions.
- O3. Residential - Provide additional residential facilities within an existing residential area to contribute towards housing targets set by State Government.
- O4. Road Reserve - Provide efficient infrastructure to enable to possibility to accommodate buses for the future educational facility and connect to the existing road network.
- O5. Stormwater Basins - To reduce the rate of stormwater runoff discharged to the public drainage network from development.

Figure 3 Indicative Land Uses



Figure 14 Land Use Plan

### 3.2 Movement Network and Street Layout

#### Objectives

- O1. Create a safe and permeable road network that caters for pedestrians, cyclists and vehicles.
- O2. Provide opportunities to extend the pedestrian and cycle routes beyond the site boundaries.

#### Controls

- C1. Vehicular movement and directions are in accordance with the Access and Movement Network in **Figure 4** and associated indicative street sections.
- C2. The new access road from Joseph Street, with a left-in left-out arrangement, is required prior to the commencement of construction of the residential development or new school, whichever comes first.
- C3. A signalised intersection on Joseph Street is required prior to the operation of any educational establishment on site.
- C4. Betty Cuthbert Drive is to be permanently closed between the New Street and Ironbark Crescent to separate local traffic and future development. This shall be undertaken prior to the commencement of construction of the residential development or new school, whichever comes first.

Figure 4 Access and Movement Network



### 3.3 Pedestrian and cycle circulation

#### Objectives

- O1. Encourage and facilitate walking and cycling within the site and the general neighbourhood.
- O2. Encourage use by pedestrian and cyclist use of the site by:



- providing footpaths on all streets on the site;
- providing safe and high amenity pedestrian linkages connecting all major activities and open spaces;
- designing for safe on-street cycling conditions along residential streets;
- providing bicycle parking at key locations;
- providing new pedestrian and cycle access to adjoining housing development to the south and east
- allowing for future pedestrian/cycle links to adjoining sites and regional routes and integrating accessibility for the mobility impaired.

**Controls**

- C1. Pedestrian and cycle routes shall be provided in accordance with the Access and Movement Network in **Figure 4**.
- C2. Streetscaping/public domain design shall strengthen the connection within the site and to surrounding residential development and other local amenities.
- C3. Pedestrian and cycle access is to be maintained between the existing development and the site at the point where the road closure of Betty Cuthbert Drive is located.

**3.4 Parking**

**Objectives**

- O1. Maintain high amenity of the residential neighbourhoods by ensuring that adequate provision is made for adequate parking is provided across the precinct.

**Controls**

- C1. Parking should be consistent with the parking rates identified in Part G of the Cumberland DCP
- C2. Public parking spaces shall be provided in addition to the resident parking provided for each dwelling.
- C3. Public domain, street and landscape design shall clearly delineate parking areas.

Figure 5 Local Street A (22.5 metre road) indicative section

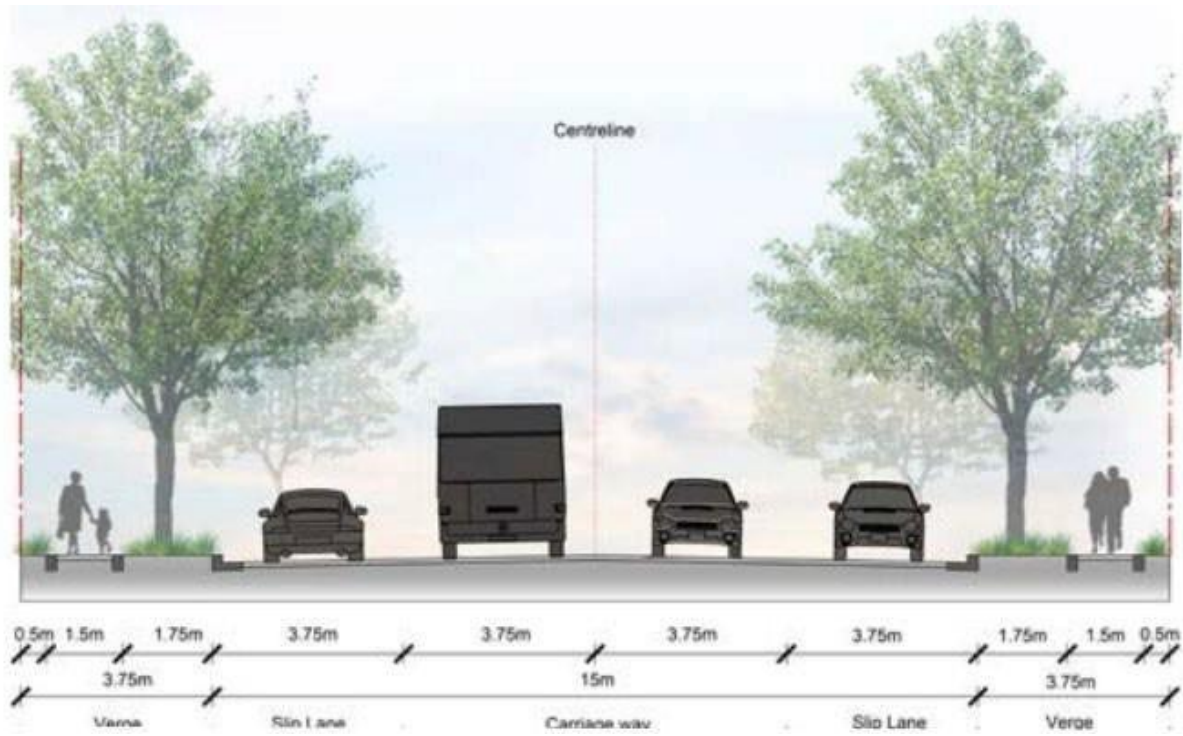

Figure 6 Local Street B (22.5 metre road) indicative section

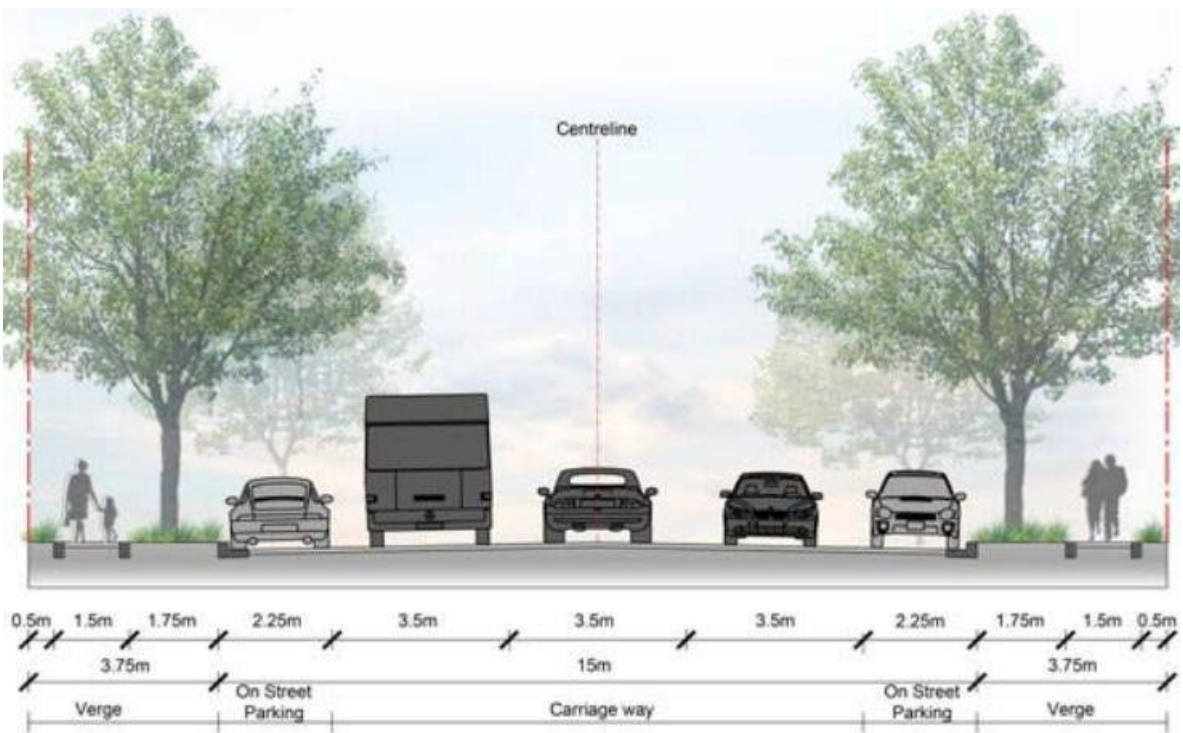
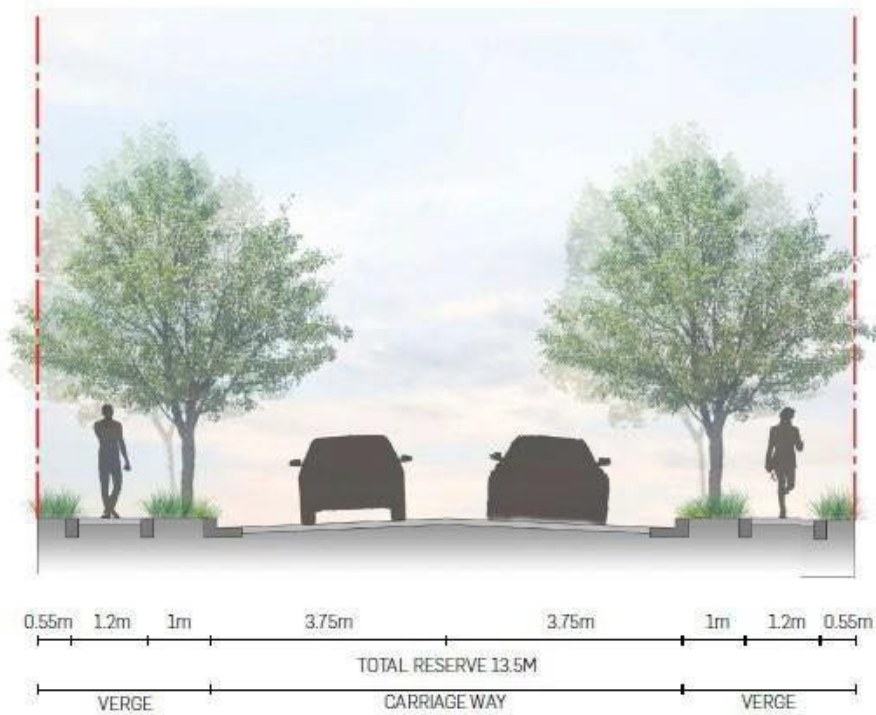

Figure 7 Local Street Type C (19 metre road) indicative section



Figure 8 Local Road Type D (13.5 metre road) indicative section



### 3.5 Landscape and Public Domain

#### Objectives

- O1. Retain high and medium value trees where possible subject to future educational establishment, MSL and residential development.
- O2. Extend streetscape character of Betty Cuthbert Drive and establish the streetscape character to the future educational establishment perimeter street.
- O3. Provide a consistent landscape buffer along Joseph Street to reflect the Botanica interface.
- O4. Maintain and enhance biodiversity on the site.

#### Controls

- C1. All development is to be consistent with the Landscape and Public Domain Strategy in **Figure 9**.
- C2. Retention of trees shall consider:
  - the safe useful life expectancy (assessed by a qualified arborist) and estimated future lifespan;
  - the current and future amenity and contribution to the landscape that the tree provides;
  - management and safety issues associated with retention
  - preliminary tree retention mapping in **Figures 10 – 15**.
- C3. Landscape design of private lots and retained existing trees shall contribute to the landscape amenity of the neighbourhood and precinct landscape framework.
- C4. Based on the preliminary tree retention mapping in **Figures 10 – 15**.
  - ‘medium retention value trees’ should be retained wherever possible but should not be a constraint on the development.
  - ‘high retention value trees’ are considered important for retention and should be retained and protected wherever possible. All opportunities for retaining these subject trees using design modification and tree sensitive construction techniques should be explored.
- C5. Street patterns and street tree planting shall be strong components of the landscape framework and contribute to tree plan.
- C6. Streetscape planting shall ensure the coherence of new plantings and continuity with key elements and themes of the existing landscape and surrounding residential developments.
- C7. Where tree removal is proposed, a tree replacement strategy must be incorporated. This strategy must demonstrate how a net increase in tree canopy shall be achieved, and how tree management will be undertaken during the life of the tree.
- C8. A biodiversity study which investigates threatened species and their habitats for the subject site is to be undertaken. The outcomes of the study are to be applied during the development of the site.
- C9. Development on the site is to meet the requirements of the Biodiversity and Conservation SEPP.



- C10. All local roads proposed within the proposed master planned area must be provided with Street tree planting that contributes to tree canopy cover through appropriate species selection where possible.

Figure 9 Landscape and Public Domain Strategy



Figure 10 Tree Retention Value Reference Map

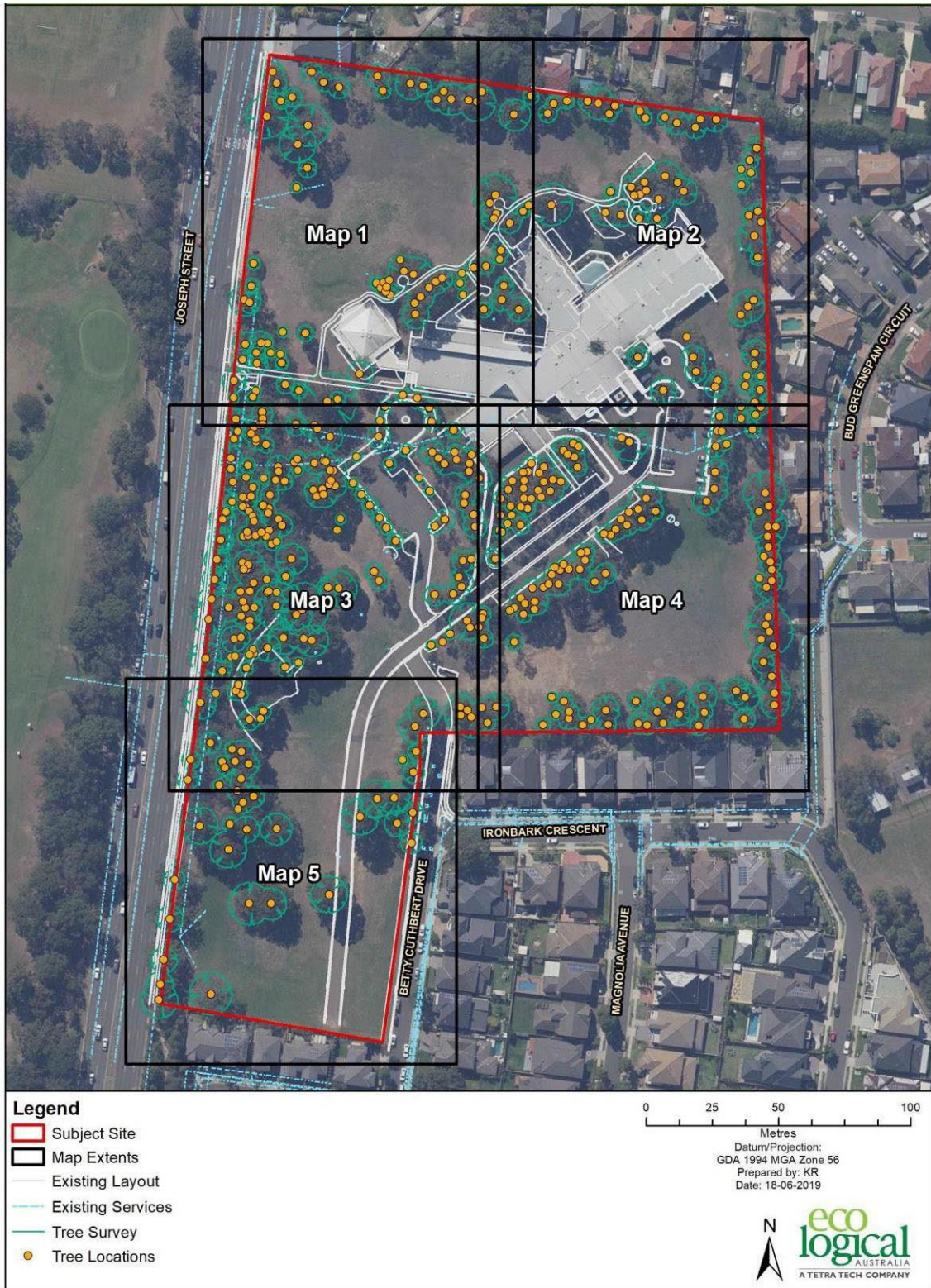



Figure 11 Tree Retention Values – Map 1

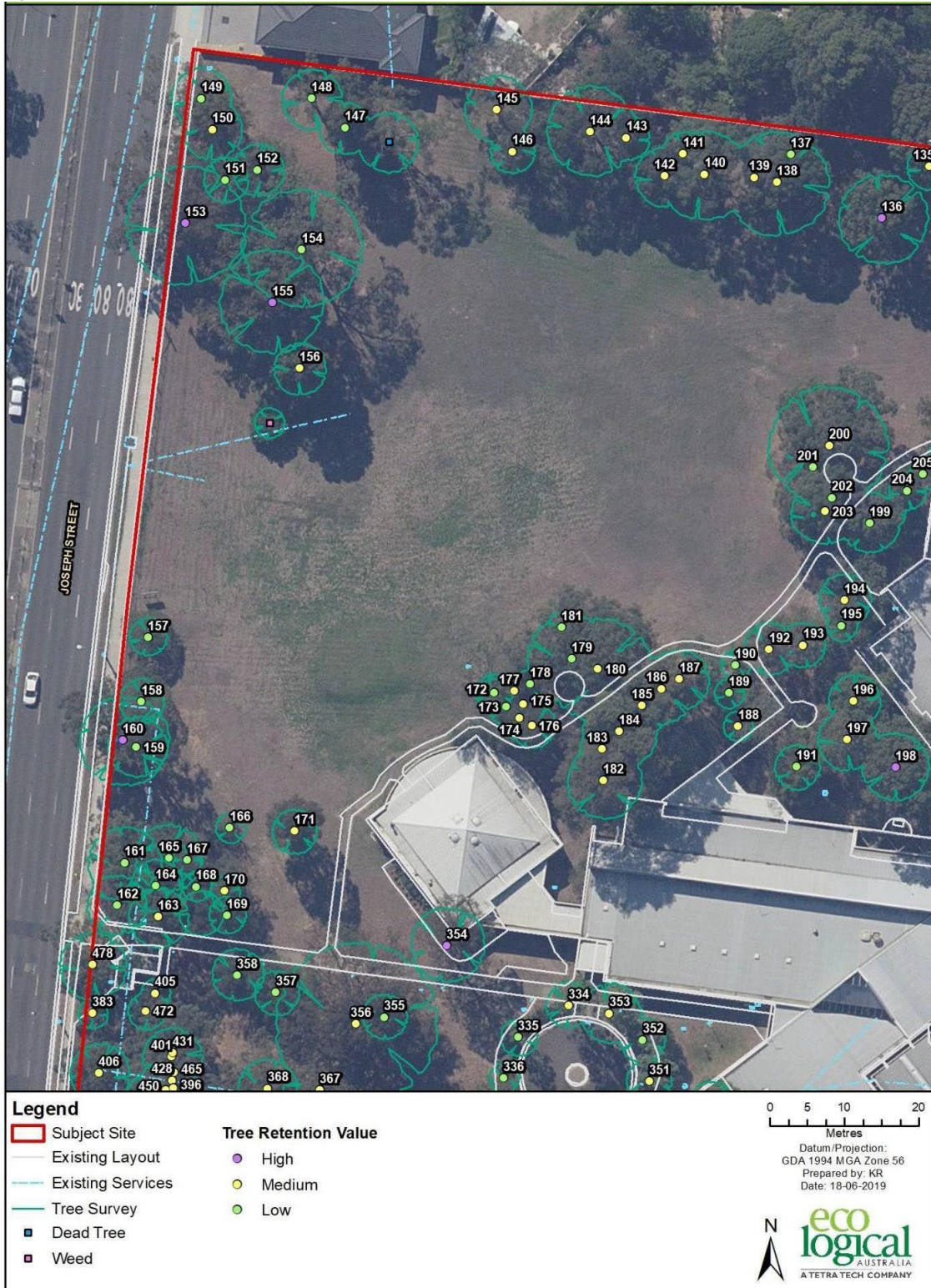



Figure 12 Tree Retention Values – Map 2





Figure 13 Tree Retention Values – Map 3

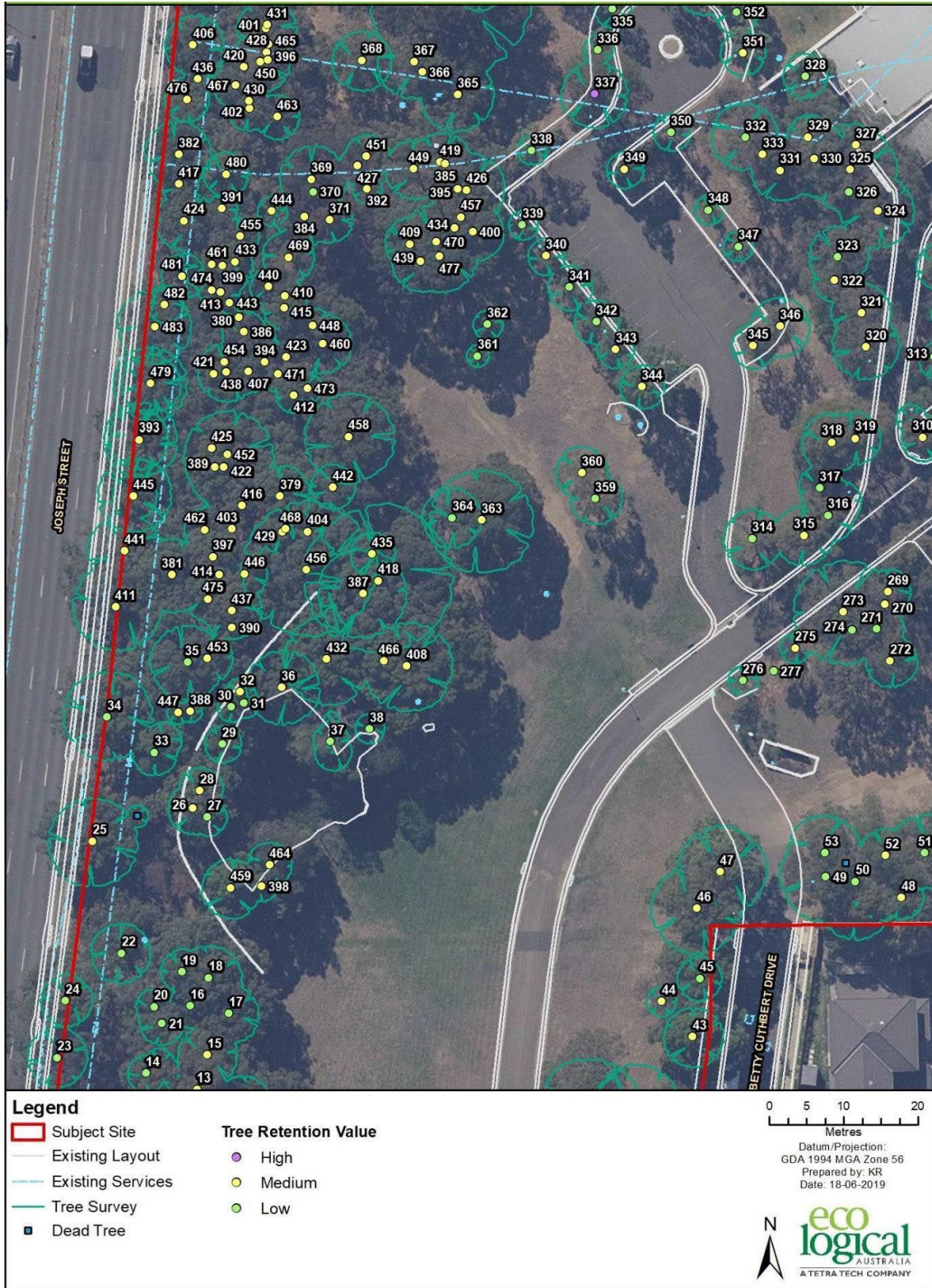



Figure 14 Tree Retention Values – Map 4

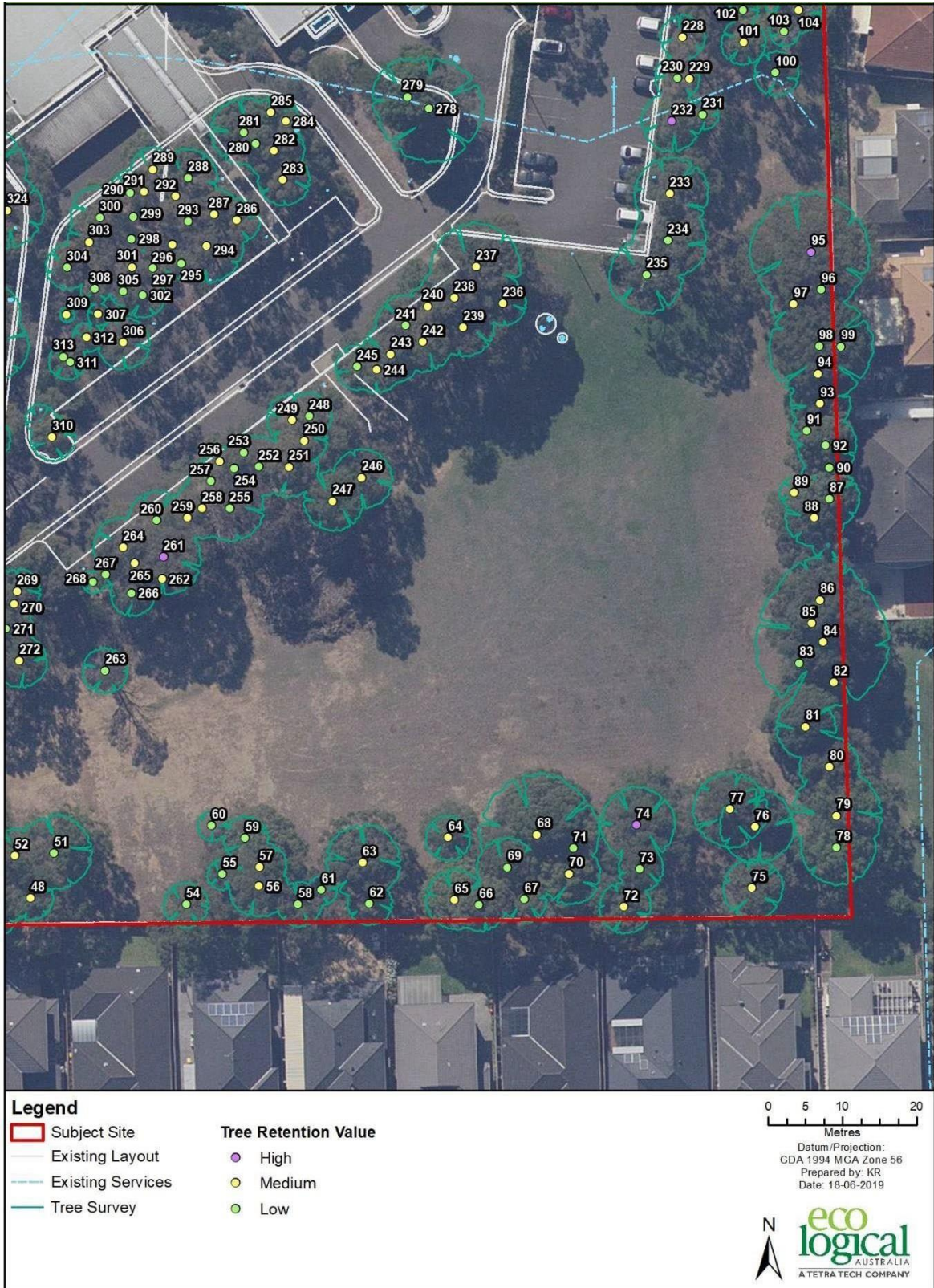



Figure 15 Tree Retention Values – Map 5





### 3.6 Proposed School

#### Objectives

- O1. Provide a framework for service and infrastructure planning to support a new school on the site to meet the needs of the local area.
- O2. Ensure that local impacts arising from the new school on the site can be mitigated.

#### Controls

- C1. A new school is to be provided on the site in accordance with the indicative masterplan.
- C2. The following framework is to be considered for the planning, design and development of a new school on the site:
  - The applicant is to proactively consult with Council to inform the service and infrastructure planning associated with the new school.
  - The design of the school is to be consistent with relevant State policies and guidelines, as well as provisions identified in the Cumberland Development Control Plan.
  - The new school shall be designed to support up to 750 students. Teaching and general staff numbers are to correspond to the maximum number of students attending the school.
  - The built form and scale of the new school must consider and respond sensitively to the existing low and medium density residential scaled surrounds of Botanica residential estate located south, R3 medium density residential proposed within the site and low-density residential surrounds located north and east of the site. This is to reduce any potential built form, scale, character, overshadowing and overlooking impacts.
  - The new school active play or open space areas shall be designed to provide a minimum of 10m<sup>2</sup> per student of open space standard at grade.
  - The new school shall be up to a maximum of four storeys. The maximum height of any structures for the school shall be located as far away as possible from the adjoining residential areas.
  - Parking shall be consistent with parking rates identified in Part G of the Cumberland DCP.
  - Traffic impacts shall be minimised by identifying infrastructure and operational solutions to encourage access to the school by walking, cycling and public transport.
- C3. Local impacts arising from the new school are to be assessed and mitigation measures identified as part of the planning and development for the new school. This includes, but is not limited to, the following:
  - Built form and function
  - Traffic, transport, parking and access
  - Acoustics
  - Environmental management
  - Plan of Management for the operation of the site.
- C4. The road network identified in the indicative masterplan that supports the school is to be provided prior to the construction of the new school.

- C5. The pedestrian overpass across Joseph Street is to be provided prior to the operation of the new school. The pedestrian overpass is to be based on the indicative design as shown in Figure 16. A kiss and ride facility on Leila Street adjacent to Coleman Park is to be integrated with the pedestrian overpass, providing safe access between the school and Berala area.
- C6. Opportunities for open space within the new school to be shared with the local community are to be considered as part of planning and development for the new school.

Figure 16 Indicative Layout of Pedestrian Overpass over Joseph Street, Lidcombe

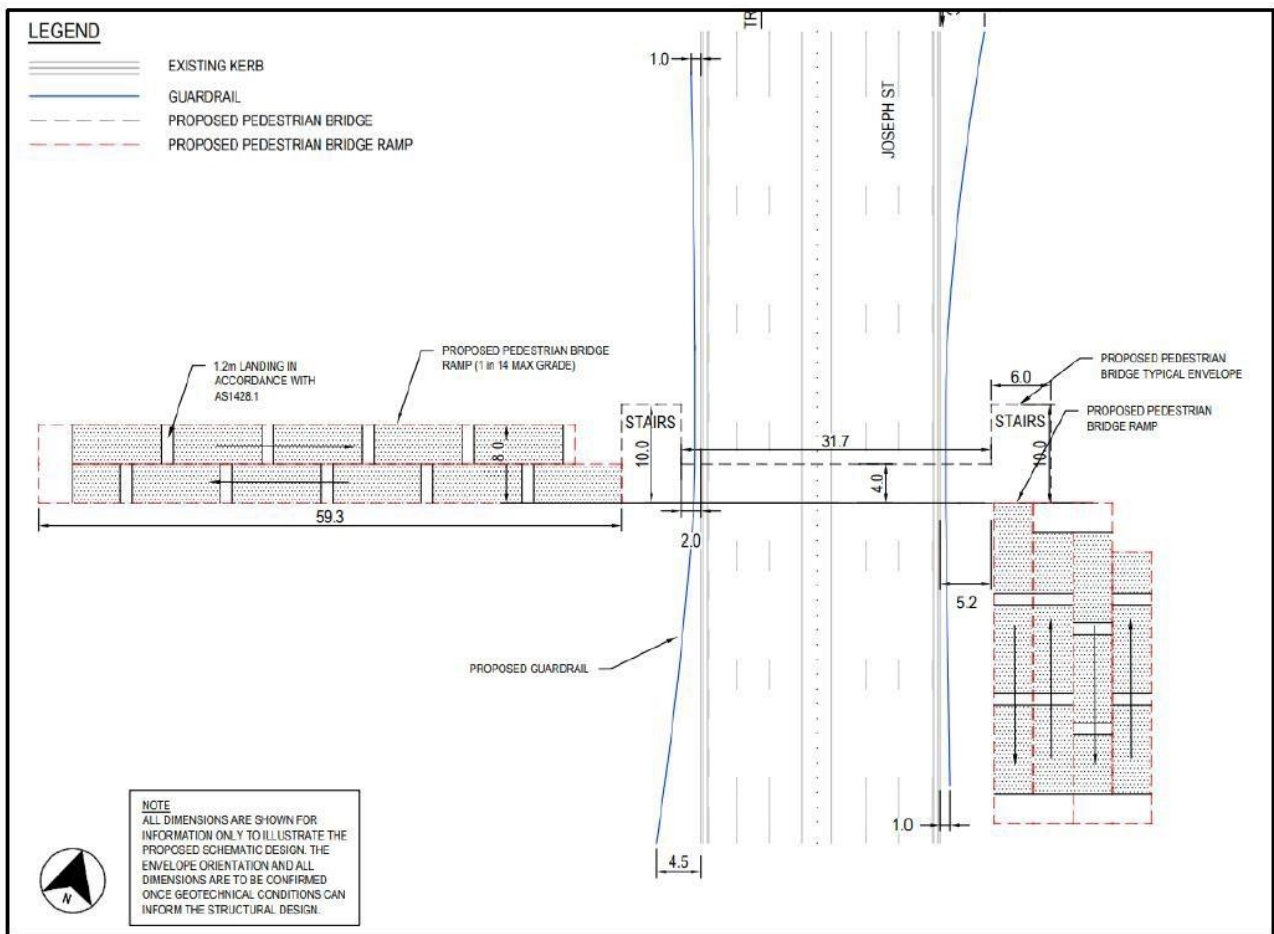

## 4 General Residential Controls

This section recognises that a range of densities is required to create a diverse built form that provides a wide choice of housing types.

A range of densities across the site is occurring and is further anticipated, and concentration of certain types is encouraged where it may be appropriate to create areas of distinct character where all other urban design, built form and housing controls can be met.

The private domain is to provide a high level of amenity to residents. The private domain includes private open space as well as the interface between private open space and dwelling interiors. Adequate solar access and privacy are fundamental qualities of the private domain.

To guide the built form and character of the private domain and to ensure that a high-quality environment is created the following principles are to be met:

- Enable flexibility in the choice of housing design and siting of a dwelling house as well as suitable space available for other activities normally associated with the use of a dwelling house.
- Provide an appropriate level of amenity for new and existing residential areas.
- Ensure appropriate levels of service for utilities and the road network are achieved and to optimise existing infrastructure.
- Adequately consider environmental constraints and impacts including flooding, drainage, vegetation, erosion on a proposed subdivision.
- Ensure the proposed development lot is of sufficient size to accommodate the form of dwelling house proposed.

### 4.1 Site Planning Controls

This section sets out the objectives, performance criteria and development standards that relate to site planning and subdivision development.

#### Objectives

- O1. The site planning and subdivision controls are to ensure that:
- interference with the topography is minimised;
  - the topography can be clearly read and understood;
  - the subdivision patterns set up regular rows of buildings and spaces and are suitable for the dwelling types;
  - a system of vehicular access to properties contributes to rather than dictates the resolution of the street; and
  - there are precincts/streets with a range of discrete characters.

#### Controls

- C1. The street and block pattern shall:
- relate to the building types;

- minimise cut and fill;
- enable small increments of change between buildings;
- enable the street hierarchy to be reinforced by the building types;
- set up an appropriate spacing between buildings;
- create a regular pattern of driveway access from the street;
- provide views and vistas;
- reinforce the qualities of the site; and
- have the potential to provide external linkages over time.

#### **4.1.1 Subdivision, allotment planning, size and shape**

##### **Objectives**

- O1. Subdivision provides for a variety of housing types to meet a variety of housing needs including meeting the needs of the aged and people with a disability.
- O2. The allotment size and shape is adequate to contain the particular housing type, open space and car parking (with the required amenity).
- O3. The allotment size and shape sets up a regular subdivision pattern related to the particular dwelling type, the street hierarchy and the block and street pattern.
- O4. The allotment size and shape allows for buildings to align with the street system.
- O5. Subdivision makes provision for dwelling houses and multi dwelling housing such as:
  - detached housing;
  - semi-detached/zero lot line houses; and
  - terrace houses.
- O6. Individual allotments permit sufficient area commensurate with the dwelling type to allow for useable outdoor open space and solar access as required elsewhere in this Part.
- O7. The allotments and the location of the buildings are organised to set up regular patterns of buildings and space.
- O8. The allotments enable a range of housing types and spatial distribution.
- O9. The irregular shaped and sized allotments provide the opportunity for specific design solutions.
- O10. The allotments are predominantly rectangular.
- O11. The allotments which provide the higher density are located around the open space system.
- O12. The allotments are located so that the dwellings relate to the street hierarchy.

**Controls**

- C1. Level changes along a street block shall be made incrementally with minimal cut and fill.
- C2. Housing types shall be built to a height of up to 3 storeys where it is necessary to define and balance the spatial system.
- C3. Minimum lot frontages for each of the dwelling types are set out in Table 1 below.

**Table 1 Minimum subdivision standards for individual dwelling types**

	Detached	Semi-detached / zero lot line houses	Terrace houses & town houses
Minimum frontage width at building line (m)	12*	7.5	6
*may be reduced to 10m if the dwelling has a garage that is accessed from the rear of the property			

- C4. Strata titling of studio accommodation shall be considered where the following outcomes are provided:
  - both the primary residence and the studio have individual frontage to a public road;
  - a minimum of 1 covered off-street car parking space is provided for the studio in addition to car parking required for the principal residence;
  - the studio accommodation has a minimum habitable floor area of 45sqm;
  - the studio accommodation has a balcony or private courtyard (designed to eliminate overlooking) of minimum 8sqm and a minimum depth of 2m;
  - the allotment on which the studio accommodation is located has a minimum width of 10m and a maximum area of 55sqm; and
  - the privacy of the principal residence’s rear yard and adjoining allotments is not compromised.

**4.1.2 Water Quantity Planning Controls**

On-site detention (OSD) is required to be designed for each lot to ensure peak flow rates at any point within the downstream drainage system do not increase as a result of development during all storm events up to the 100-year ARI, with the following requirements:

- Permissible site discharge (PSD) - 100L/s/Ha
- Site storage requirement (SSR) - Minimum of 455m3/Ha

**Objectives**

- O1. The drainage strategy takes into account a total catchment management approach such that downstream drainage systems are not impacted adversely through alteration to existing drainage flows from the site.

- O2. Drainage systems and ground surface areas are to be protected from pollutants and soil erosion. Pollutant and sediment control measures are required for all subdivision applications.
- O3. The drainage works for the site are to preserve the effectiveness of existing downstream flood mitigation and drainage works.
- O4. Proposed development is not to increase downstream flooding or increase pollutants on a total site performance basis. Off-site mitigation measures will be accepted as meeting this criteria subject to satisfactory arrangements with the affected landowner.
- O5. Stormwater infrastructure is to be designed to be aesthetically pleasing and landscaped so as to serve a dual function as a continuation of the open space and stormwater management.

#### **Controls**

- C1. Stormwater runoff from all new roof areas shall be routed through the OSD system. Runoff entering the site from upstream properties shall be directed bypassing the on-site detention system.
- C2. A portion of the new impervious areas (excluding roof areas) shall discharge directly to road drainage system if it cannot be drained to the storage facility, provided the PSD is reduced to compensate for the smaller catchment.
- C3. No more than 15% of the total site area shall be permitted to bypass the detention system.
- C4. The maximum desirable extent of impervious surfaces bypassing the detention system is 15% of the total impervious site area.

## **4.2 Residential Dwelling Controls**

### **4.2.1 Dwelling design and form**

#### **Objectives**

- O1. Housing variation caters for a socio-economically diverse community.
- O2. Ensure dwellings and garages are designed with regard to site conditions and minimise impact on landform.
- O3. Ensure dwelling and garage design has regard to the amenity of adjoining development and surrounding properties.
- O4. Ensure that dwellings have a high level of internal and external amenity.
- O5. Denser housing forms are to be located around open space and on wide verges.
- O6. Dwelling groups are not composed of different dwelling types (e.g., terrace dwellings are to stand alone as one group).
- O7. Taller or raised housing forms are to be located where land slopes away from an open space or across the width of the street.
- O8. Where land slopes along the street, dwellings to follow the slope of the land.

- O9. Floor to ceiling heights to enable good light penetration and cross ventilation.
- O10. Ensure that groupings of similar types of dwellings create areas of a particular identity in the built form and streetscape.
- O11. Ensure that dwelling design and types reinforce corners, the street, and open space hierarchy.
- O12. Dwellings and garages are designed with regard to the site conditions and minimise the impact on landform.

**Controls**

- C1. A minimum of 20% of the total number of dwellings shall be detached dwellings.
- C2. The building height controls and floor to ceiling controls applicable to buildings are set out in the Table 2 below.

**Table 2 Floor to ceiling heights**

	Levels	Minimum	Maximum
Dwellings	Ground floor	2.7m	3m
	1 <sup>st</sup> and 2 <sup>nd</sup> floor	2.4m	2.7m

- C3. The maximum building depth of any second or third storey components of dwellings shall be 14m.
- C4. Stairs, verandahs, entry features, courtyard walls, balconies, carports and porticos may encroach within the primary building line by not more than 2m provided the design, materials, colour and construction match the main dwelling.
- C5. Dwellings shall be predominantly 2 storeys with some component of single storey. 3 storey dwellings shall be considered if they are on sites where it can be demonstrated that it enhances the streetscape and/or legibility.
- C6. The floor level of any dwelling shall be a minimum of 500mm above the 1% AEP level of any adjacent drainage easement or water course or OSD facility.
- C7. Garage door openings fronting a public road shall be not be more than 5m wide or 50% of the frontage width of the allotment measured at the building alignment, whichever is the greater.
- C8. Garage door fronts shall be setback a minimum of 5.5m from the street boundary and 1.5m back from the front dwelling façade.
- C9. Garages, particularly doors, carports and parking areas shall be detailed to reduce their visual impact and add interest at ground level. The materials used in the garage shall complement those of the house.
- C10. Garage and carport design shall be in the same application as the dwelling even if it is to be constructed at a later date.



- C11. Carports shall be designed so that secondary elements do not dominate the dwelling façade.
- C12. Pitched roofs to carports shall not permitted unless compliance with the streetscape objectives can be demonstrated and the carport structure does not dominate the dwelling façade.
- C13. Carports shall be a maximum of 3.5m in width.
- C14. Carports shall be designed as open pergola type structures. This may include a flat roof and shall not be screened on the sides or front.
- C15. Carport structures shall be setback a minimum of 2m from a primary street front boundary.
- C16. Carport structures shall not exceed 3.5m in height including all elements.

#### **4.2.2 Density of dwellings**

##### **Objectives**

- O1. Density is to be optimised while allowing for:
  - adequate open space;
  - appropriate curtilage for landscape of exceptional and high value;
  - a street and block system which suits the building typologies and enables the reading of the landscape setting; and
  - minimum intrusion on the topography.

#### **4.2.3 Site Coverage**

##### **Objectives**

- O1. Site coverage enables the proposed building type, adequate open space and the required car parking.
- O2. Site coverage varies to suit the dwelling type i.e. terrace houses require greater site coverage than detached houses.
- O3. Development achieves:
  - a clear physical (bulk) relationship between each building type and its allotment size with regard to creating neighbourhoods of some homogeneity; and
  - adequate separation between dwellings particularly at the rear of the site.

##### **Controls**

- C1. The maximum site coverage for residential development as a percentage of the total site area for each dwelling type shall be compliant with the requirements set out in Table 3 below.

**Table 3 Minimum site coverage**

		Detached	Semi-detached / zero lot line houses	Terrace houses & town houses
Maximum coverage	site	55%	60%	70%

#### 4.2.4 Setbacks

Setbacks are required to protect the privacy of adjoining residents, to provide for sunlight to adjoining dwellings and to provide a visual rhythm and coherence to the streetscape.

##### Objectives

- O1. Ensure that the dwellings address the public domain and set up a spatial rhythm.
- O2. Ensure there is adequate solar access and privacy
- O3. The setbacks to the street need to provide:
  - a clear reading of the topography;
  - a clear edge to the street and/or open space system;
  - a semi-private zone;
  - houses which are more dominant than garages;
  - reinforcement of the street hierarchy;
  - reinforcement of the street block where appropriate; and
  - an open streetscape with adequate areas for landscaping, fencing, and screen planting.
- O4. The setbacks to the side boundary and the rear are to ensure that there is:
  - adequate solar access to neighbours;
  - privacy for residents and neighbours, and minimise overshadowing; and
  - an even spatial rhythm along the street so that individual building types do not dominate.

##### Controls

- C1. Table 4 below sets out the minimum setback requirements for all dwelling types on the site.

**Table 4 Minimum setback requirements for all dwelling types**

All Dwelling Types	
Primary front setback	4m to building façade of habitable rooms from the front boundary line. This setback may be reduced to 3m for dwellings fronting public open space or a corner, providing solar access and other environmental provisions are met.
Side and rear set back	A 1.2m side setback is required for 1 and 2 storey portions of dwellings.
	Garages, including those with studio accommodation above, in lanes can be located on the rear boundary provided a minimum of 7.5m is provided between the façade and opposite boundary fence or building façade. (Refer below for additional requirements).
Eaves/facias	825mm for 1 or 2 storey buildings.

- C2. Garages facing a street shall be set back a minimum of 5.5m from the front boundary.
- C3. Two storey, open, non-habitable structures including carports, pergolas, verandahs and entry features shall sit within the 2m articulation zone as measured from the primary front setback.
- C4. Adjoining building facades shall be aligned. Building facades may vary in alignment only if a cohesive streetscape is achieved. Any variation to the alignment shall be derived from the building type and the topography, i.e. where a lot slopes away from an area of parkland or to achieve a more successful result by locating a building or group closer to the street edge.

#### 4.2.5 Orientation

##### Objectives

- O1. Ensure that the orientation and organisation of lots will enable dwellings to achieve the environmental performance guidelines as set out in section 2 of this Part.
- O2. The building zone for the dwelling is predominantly at the front of the lot.
- O3. The higher density areas with smaller lot frontages are predominantly east-west or north-south where the north is at the rear.
- O4. Ensure the subdivision of allotments maximises the potential for energy efficient housing development whilst maintaining the design integrity of the overall development.
- O5. All allotments are to provide for sufficient area to allow the siting of dwellings and to allow for adequate areas of private open space, vehicle access and parking as set out elsewhere in this Part.

### **Controls**

- C1. Lots shall be oriented to facilitate the siting of dwellings to meet the Ecologically Sustainable Development (ESD) criteria set out in this Part.
- C2. The above requirements may be varied in cases where an applicant submits an integrated subdivision and development application demonstrating that the performance criteria have not been compromised.

### **4.2.6 Private open space and landscaping**

#### **Objectives**

- O1. Private open space areas are to:
  - relate to the living spaces, windows, access/egress points and function of the dwelling; and
  - be amenable and suitable for the intended use.
- O2. All setback areas are to be landscaped to Council's satisfaction.
- O3. Ensure private open space is of a size and location suitable for the intended use.
- O4. Private open spaces and living areas are protected from overlooking from public and neighbouring areas.
- O5. Private open space areas are clearly defined and screened for private use.
- O6. Landscape treatment of private open space areas contribute to the master planned themes for streetscape and public open space (where private open space is visible from these public areas).
- O7. Landscape treatments complement solar access requirements for buildings.
- O8. Planting:
  - is appropriate for its setting and environment;
  - is provided in the public and private domain;
  - complements the existing landscaping and topography, lighting and street furniture;
  - is simple and robust; and
  - provides privacy, screening and shading where required.
- O9. All new landscaping is to be designed to be low maintenance and low water usage.

#### **Controls**

- C1. New plantings shall contain endemic species that are of low maintenance and low water usage.
- C2. Cultural plantings shall be used where existing plantings are to be enhanced.

- C3. The minimum area of soft landscaping for residential development as a percentage of the total site area for each dwelling type shall be as set out in Table 5 below.
- C4. Private open space shall be of a minimum size as set out in Table 5 below and be able to contain a square measuring a minimum of 4m x 4m which is free from obstructions such as garden beds and steps.
- C5. Private open space areas associated with residences shall accommodate outdoor recreation needs and function as an extension of interior living areas.
- C7. Planting shall be used to minimise overlooking between dwellings, and between dwellings and public or common areas; having regard to crime prevention principles.
- C8. Planting shall be of appropriate mature heights and volumes to the space allotted to them.
- C8. The area between the front property boundary and the front building line shall not be considered as private open space unless solar access is principally to the front garden space and this area is suitably fenced and screened.

**Table 5 Minimum private open space per dwelling type**

	Detached	Semi-detached / zero lot line houses	Terrace houses & town houses
Minimum area of private open space	70m <sup>2</sup>	60m <sup>2</sup>	35m <sup>2</sup>
Minimum landscaped area of site	45%	40%	30%

#### 4.2.7 Architectural Expression

##### Objectives

- O1. Ensure that dwellings relate well to one another and contribute to the quality of each precinct and the overall quality of the development.
- O2. The architectural expression of dwellings is to ensure that:
  - attached housing has clearly defined party walls which enable buildings to adjust to the topography without large benching;
  - roof forms in attached housing are to reflect the stepped changes at ground level;
  - a high standard of architectural design of both individual dwellings and groups of dwellings;
  - special urban design features are reinforced such as the alignment of roads which curve towards a spatial gateway or landscape focus;

- building entries are clear and legible;
- windows, facades and rooms are well proportioned;
- materials and detailing are appropriately used;
- roof forms are used which relate to the definition of space and do not create big buildings such as hip roofs on runs up terrace houses are not appropriate;
- attention to both the building base and roof is required;
- roof forms in attached housing reflect the stepped changes at ground level;
- windows to main rooms are directed to the front and rear
- the head height of windows relate to the height of the ceiling; and
- there is variety but continuity between dwellings.

### **Controls**

C1. Design of dwellings shall consider the following:

- Articulation of building facade using:
  - material and detailing;
  - legible building entrances;
  - balcony and other elements; and
  - well proportioned openings, window, type and size.
- corner buildings shall be articulated to reinforce the corner condition by addressing both street frontages;
- building elements such as balconies, verandahs, pergolas, sun shading, porches and other elements shall be used to articulate the façade;
- windows to living areas shall be directed either to the street or rear private open space (and vehicular access ways) to provide surveillance to the street and other open space areas;
- modulation of the facade shall be integral to the design of the building, its setting and not arbitrary;
- level changes along a street block shall be made incremental with minimal cut and fill; and

C2. Windows and doors, particularly those that face the street, shall be provided in a balanced manner and respond to the orientation and internal uses.

#### **4.2.8 Adaptable Housing**

##### **Objectives**

- O1. Ensure a sufficient proportion of dwellings include accessible layouts and features to accommodate changing environments of residents.
- O2. Development to allow for dwelling adaptation that meet the changing needs of people's lifestyle.

##### **Controls**

- C1. A minimum of 10% of the total number of dwellings shall be constructed so as to be adaptable for use by aged or disabled occupants in accordance with the relevant provisions of the Building Code of Australia and Australian Standards.
- C2. Refer to the requirements for adaptable housing in Part B of this DCP.

#### **4.2.9 Building materials**

##### **Objectives**

- O1. Ensure that materials are durable and have a long life.
- O2. Ensure that materials have low embodied energy.
- O3. Ensure that materials contribute to the design of the buildings in terms of aesthetics and comfort.
- O4. Materials are to:
  - create a high-quality finish which is robust over time;
  - be appropriate to the scale and detailing of the building;
  - relate well to one another; and
  - provide thermally responsive dwellings.

##### **Controls**

##### **Walls**

- C1. Exterior walls shall be predominantly masonry and/or timber. Lightweight materials especially timber can be used to add interest and texture to the building and to break up larger expanses of wall.
- C2. Bolder brighter shades for areas of detail shall be appropriate provided that these are in keeping with the overall colour scheme of the house and do not detract from the general harmony of the street.

##### **Roofs**

- C1. Single colour tile roofs are preferred. Pre-finished metal sheeting may be used on concealed roofs or "lean to" construction.
- C2. Colours shall reinforce the character of the precinct.



## **Windows**

- C1. Windows may be constructed of timber or pre-finished aluminium and shall be in a dark colour.

### **4.2.10 Solar Amenity**

#### **Objectives**

- O1. Ensure that housing design is energy efficient, assists in developing ecologically sustainable residential communities and leads to a reduction in the household use of fossil fuels.
- O2. The design of buildings minimises household energy needs, utilises passive solar design principles and ensures adequate solar access.
- O3. Shading to western walls is to be provided where not overshadowed by adjoining walls or vegetation.
- O4. Roof insulation is incorporated into all residential development.
- O5. All dwellings have high levels of light penetration.
- O6. Cross ventilation is provided.
- O7. Buildings are to be designed with windows that are located, sized and/or shaded (including the use of eaves) to facilitate thermal performance and minimise the use of artificial light during daylight hours.
- O8. The design of residential dwellings is to demonstrate passive design principles including:
- window placement;
  - building orientation;
  - shading;
  - insulation;
  - ventilation; and
  - sensitive landscaping.

#### **Controls**

- C1. The use of materials shall minimise energy use over their whole lifecycle.
- C2. All residential buildings, where not affected by external noise sources, shall be able to be operated in a naturally ventilated mode and achieve comfortable internal conditions.
- C3. Vegetation shall be used to cool the ambient temperature within the development. Selective use of trees shall include consideration of deciduous trees to provide shading in summer and allow passive heat in winter.

- C4. Buildings shall be designed to allow passive heating in winter. Selective shading shall be applied so that the high angles of sunlight in summer do not penetrate the buildings.
- C5. Distances between buildings shall be designed to allow natural light to dwelling living spaces.

#### **4.2.11 Privacy and overshadowing**

##### **Objectives**

- O1. Ensure the design of buildings and position of windows respects the privacy of adjoining residents.
- O2. Buildings are to be sited and designed to ensure provision of daylight to habitable rooms in adjacent dwellings and neighbouring open space including the private open space associated with dwellings.
- O3. Buildings are to be designed to ensure appropriate levels of privacy.
- O4. Developments are to include site planning, building design and landscaping that minimises the overshadowing of adjoining properties.

##### **Controls**

- C1. Windows to living areas shall face predominantly to the street and to the rear.
- C2. Windows to living areas that face directly on to windows, balconies or private open space of adjoining properties shall be appropriately screened and/or have reasonable separation. A distance of 9m between openings of separate dwellings is required unless other mitigating measures are adopted.
- C3. First floor balconies shall not be permitted where directly overlooking living areas of adjacent dwellings unless suitable screening is provided.
- C4. At least 50% of the ground level private open space shall receive not less than 3 hours of sunlight between 9:00am and 3:00pm on June 21 for a minimum of 80% of all dwellings.
- C5. At least one internal living area shall have access to a minimum of 3 hours of direct sunlight between the hours of 9:00am and 3:00pm on June 21. This shall be achieved for a minimum of 80% of all dwellings.

#### **4.2.12 Fencing**

##### **Objectives**

- O1. Fencing is to:
  - clearly demark the public, semi-public and private domains;
  - complement the dwellings and the streetscape; and
  - provide privacy where appropriate.
- O2. All new dwellings to have side and rear boundary fences.

- O3. Front fences, where appropriate, contribute to the streetscape and allow gardens to contribute to the public domain
- O4. Front fences, where appropriate, extend alongside boundaries of corner sites back to the building line.
- O5. Ensure that rear and side fencing assists in providing privacy to private open space areas.
- O6. Fence height, location and design should not affect traffic sight distances at intersections.
- O7. Ensure that front fences relate in proportion to the height of the building and are appropriate to the style of residence

#### **Controls**

- C1. Side boundary fencing constructed behind the building alignment setback shall be a maximum height of 1.8m and be constructed from materials which complement the design of the dwelling.
- C2. The front and side dividing fences where located within the front yard area shall not exceed a height of 1.2m as measured above existing ground level and shall be a minimum of 50% transparent.
- C3. Front and side dividing fences where located within the front yard area shall not be constructed of solid pre-coated metal type materials such as Colorbond or similar.
- C4. Front fencing that is to provide privacy screening for external living areas shall be considered up to a maximum height of 1.8m if complementary to the dwelling design.
- C5. Fencing to secondary road frontages and rear vehicular access shall be a maximum of 1.8m in height at the road boundary from the rear boundary up to the line of the front of the dwelling and must be of materials and design complementary to both the streetscape and dwelling.
- C6. Front fences shall be compatible with and sympathetic to the dwelling design.
- C7. Fencing styles shall complement both the architectural design of the dwelling and the streetscape. Front fences should not exceed 1.2m in height unless required for provision of privacy to private open space and unless appropriately screened by landscaping and with variations in materials and alignment.

#### **4.2.13 Waste controls**

Waste requirements should be consistent with the relevant controls identified in Part G of the Cumberland DCP.

#### **4.2.14 Parking and loading controls**

Parking requirements should be consistent with the relevant controls identified in Part G of the Cumberland DCP.



CUMBERLAND  
CITY COUNCIL

**PART F1-20**  
**1 CRESCENT STREET,**  
**HOLROYD**

This page has been left intentionally blank.

# 1. Introduction

## 1.1 Land to which this Part applies

This Part applies to land at 1 Crescent Street, Holroyd. The site is legally known as Lot 700, DP 1241836 and shown at Figure 1.



Figure 1: Land to which this Part applies

## 1.2 Relationship to other parts of Cumberland Development Control Plan 2021

This site specific Development Control Plan (DCP) forms part of Cumberland Development Control Plan (Cumberland DCP) 2021. This Part should be read in conjunction with all other parts of the Cumberland DCP which contains objectives and development controls that relate to development in this Part.

- Part A - Introduction and General Controls
- Part B – Development in Residential Zones
- Part C – Development in Business Zones
- Part D – Development in Industrial Zones
- Part E – Other Land Use Based Development Controls
- Part G – Miscellaneous Development Controls

In the event of any inconsistency between this Part and other Parts of the Cumberland DCP 2021, this Part will prevail to the extent of the inconsistency.

### **1.3 Purpose of this Part**

The purpose of this DCP' is to articulate the detailed built form controls and to outline the site-specific controls to guide the development at 1 Crescent Street, Holroyd (the site). The DCP shall also be considered with the site-specific provisions identified in the Cumberland Local Environmental Plan (Cumberland LEP) 2021.

No savings provisions apply to development applications that are considered for this site.

## **2. Vision and desired future character**

### **2.1 Vision**

The redevelopment of 1 Crescent Street, Holroyd, will support housing diversity and affordability, and neighbourhood retail and commercial land uses with new opportunities of publicly accessible open space for community uses and to complement and enhance the Holroyd area and surrounds.

### **2.2 Desired future character**

The objectives of this Part are to:

- O1. Provide a clear vision, development principles and controls for the development of the site.
- O2. Encourage high quality architectural, public domain, and landscaping outcomes that positively contribute to the character of Holroyd.
- O3. Ensure buildings are located to respond to the site's location and the surrounding context.
- O4. Ensure ample provision of publicly accessible open space with connectivity to existing open space areas that improve environmental and amenity outcomes.
- O5. Safeguard opportunities for on-site employment while also providing a diversity of new housing to cater for a range of housing needs.
- O6. Provide safe and efficient vehicle access and circulation within the development.
- O7. Improve pedestrian and cycle connectivity through the site to existing cycle paths and pedestrian networks that lead to key transport and employment nodes.
- O8. Encourage sustainable transportation mode on the site through connectivity to, and increase use of public transportation.

### **2.3 Desired future character statement**

A high-quality, well designed, safe and attractive high-density development, that is focused on new open space and local shops to provide a high amenity setting and outlook for the residents and located near Merrylands and Granville. The Precinct will attract a range of jobs and retail uses.

To achieve a high-quality outcome for the development of the site, the development of the site is to demonstrate consistency with the following urban design objectives:

- O1. Enhance the quality of the local area, particularly through provision of new public open space, increased greening, and improvements to A 'Becketts Creek.



- O2. Improve public transport, pedestrian and cycleway connectivity within the local area including through the site.
- O3. Promote a 'green and leafy' character for the local area.
- O4. Maintain a sense of spaciousness for development.
- O5. Provide appropriate interfaces to surrounding uses.
- O6. Ensure impacts from surrounding noise sources are appropriately mitigated through building design and use of materials.

## **2.4 Masterplan**

### **Objectives**

- O1. Provide a framework for the future high-quality renewal of the site.
- O2. Ensure the delivery of new open space and adequate social infrastructure and services.
- O3. Ensure a range of jobs are provided on the site.
- O4. Ensure the development responds to the site's location and its surrounding urban context.
- O5. Ensure high amenity buildings that maximise views to open space.
- O6. Minimise potential visual and amenity impacts to surrounding properties and public open space.
- O7. Minimise operational impacts to the surrounding transport network through provision of necessary infrastructure.

### **Controls**

- C1. Development of the site should generally be in accordance with the masterplan identified in Figure 2 and the key features listed in Table 1.
- C2. Heights, massing and design should respond to the site's prominent location by concentrating the tallest buildings toward the north-east of the site to mark the important junction of Woodville Road, Parramatta Road, Church Street and the M4 entrance ramp. Building heights and separations towards the south-west corner of the site should appropriately respond to the existing industrial and residential uses.
- C3. The arrangement of buildings should prioritise views towards the Holroyd Sportsground and new public open space.
- C4. Provide a maximum of 5,000sqm of commercial gross floor area and a maximum of 2,500sqm of retail gross floor area within the development.
- C5. Provide a range of public and communal open spaces and facilities, including:
  - an embellished and dedicated public open space based on the RE1 zoning (approximately 7,700sqm);
  - publicly accessible open space across the site; and
  - adequate communal open space to support residents and reduce demand on local services.



Figure 2: Indicative site masterplan  
(adapted from Architectus Updated Masterplan, dated 3 August 2021)

Table 1 – Key features of the masterplan

<b>Key features</b>	
<b>1</b>	A new public open space for Holroyd with connections to existing open space to the north of the site, providing opportunities for improvements to A'Becketts Creek and the Holroyd Sportsground.
<b>2</b>	Pedestrian permeability throughout the site and strong pedestrian and cycle connectivity to the broader area including transport hubs.
<b>3</b>	Buildings are designed to respond to the site's location as a gateway to Holroyd and the surrounding urban context through: <ul style="list-style-type: none"> <li>• Increased building heights, up to 28 storeys, located towards the Woodville Road, Parramatta Road and M4 junction to the north-east.</li> <li>• Present suitable scale of street wall height along Woodville Road to enable appropriate commercial and retail uses in this location.</li> <li>• Provide sufficient building separation and stagger building heights by stepping it down towards the south-west.</li> <li>• Minimise overshadowing impacts through building orientation and separation.</li> <li>• Maximise building frontage and outlook to open space to improve solar access and natural ventilation.</li> </ul>
<b>4</b>	Ground and podium level commercial and retail uses, including potential for a supermarket, child-care centre, office, gym, medical centre and other uses.
<b>5</b>	Provide safe and efficient internal circulation with vehicle access to the Precinct achieved from Crescent Street.
<b>6</b>	Develop appropriate interface with adjoining uses on the western boundary.

## 2.5 Provision of infrastructure and services

Future development on the site shall ensure that the provision of regional and local infrastructure and services is adequately provided to meet the needs of future residents, visitors and workers.

This provision is in addition to infrastructure contributions that may be levied for development, and may be provided as a monetary contribution and/or works-in-kind. This shall be addressed through development applications on site, and be to the satisfaction of Council. It includes, but is not limited to, the following:

- Affordable housing on the site to be dedicated in perpetuity to Council or a Community Housing Provider, consistent with the offer provided as part of the planning proposal for the site;
- Regional infrastructure in accordance with NSW Government and Council requirements, and consistent with the offer provided as part of the planning proposal for the site; and
- Local infrastructure in accordance with Council requirements, such as upgrades to Holroyd Sportsground (including connections with the site), upgrade of the Pitt Street and Walpole Street intersection to meet future demand arising from development on the site, and improved walking and cycling links between the site and Merrylands Town Centre.

## 3. Development Controls

### 3.1 Building heights and street wall heights

#### Objectives

- O1. Provide a variety of building heights and an interesting skyline.
- O2. Ensure buildings respond to the site's urban context and views to and from surrounding areas.
- O3. Concentrate the tallest buildings toward the north-east of the site to mark the important junction of Woodville Road, Parramatta Road, Church Street and the M4 entrance ramp.
- O4. Ensure a comfortable street wall height that enhances pedestrian amenity with adequate daylight, scale, sense of enclosure and wind mitigation.
- O5. Ensure buildings are appropriately setback above the street wall height and ensure towers provide an appropriate scale transition to the street.
- O6. Ensure building heights minimise overshadowing and privacy impacts.

#### Controls

- C1. Building design should utilise a 'podium and tower' approach with a human-scale street wall of 1-8 storeys and tall, slender towers of 12-28 storeys.
- C2. Building heights should generally be in accordance with the building heights shown in Figure 3 and in Table 2.



Table 2 – Building heights and locations

Building no.	Location	Maximum height in storeys	
		Podium	Tower
1	North-east, adjacent to Woodville Road Great Western Highway junction	2 - 6	28
2	Northern boundary, adjacent to A'Becketts Creek - Northern podium between Buildings 1 & 2 - All other podiums	1 8	26
3	South-east, adjacent to Crescent Street and Woodville Road intersection	2 - 6	22
4	Southern boundary, adjacent to Crescent Street	1	11
5	Southern boundary, adjacent to Crescent Street	8	14
6	South-west, adjacent to Crescent Street	8	16
7	Adjacent to western boundary	8	16



(adapted from Architectus Updated Masterplan, dated 3 August 2021)

- C3. Buildings with a frontage to Woodville Road require a minimum street wall height of 8 metres, to be used for non-residential uses to promote the prominence of the site adjacent to the Woodville Road, Parramatta Road and M4 junction as shown in Figure 4.
- C4. The ground level of all other buildings should have a minimum 3.6m floor to ceiling height to provide flexibility for a range of uses.
- C5. Variation in building height and form across the site should be used to provide visual diversity.
- C6. Building heights are to reduce impacts of overshadowing to properties to the south and south-east.

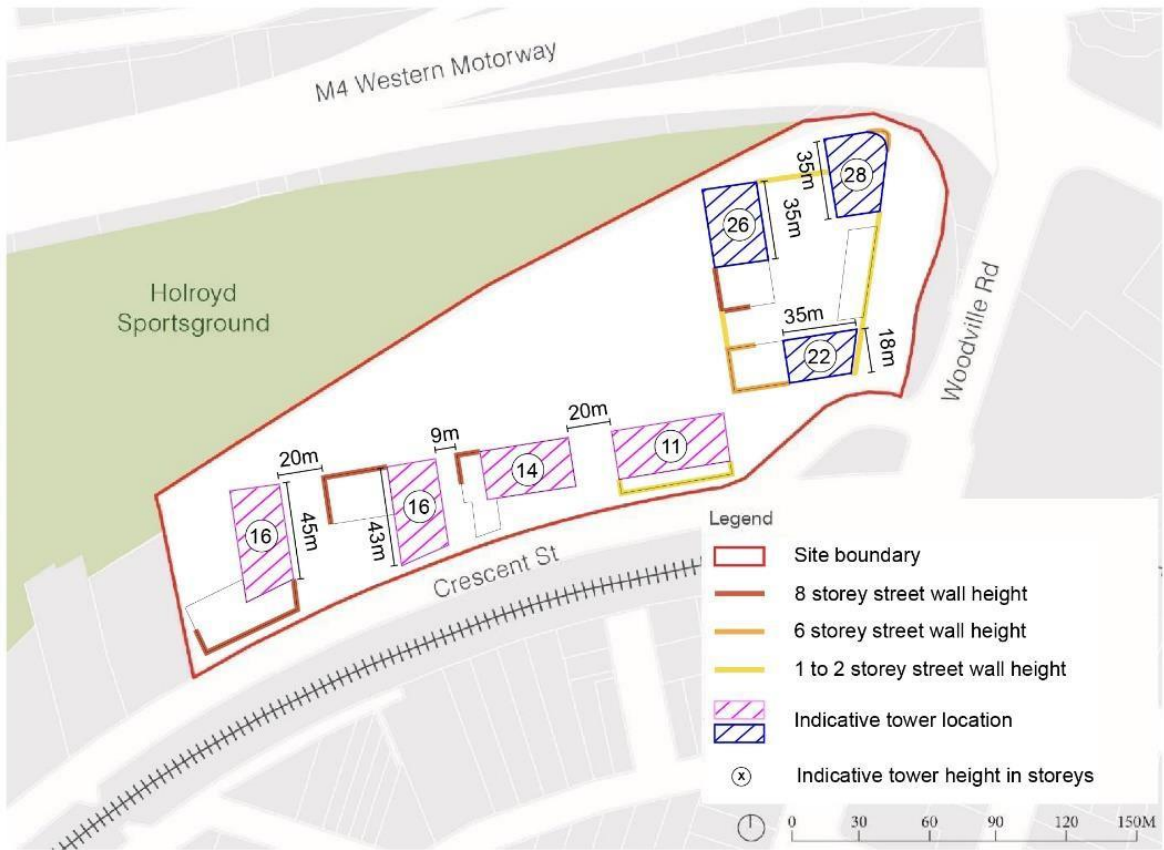

Figure 3: Building heights  
(adapted from Architectus Updated Masterplan, dated 3 August 2021)

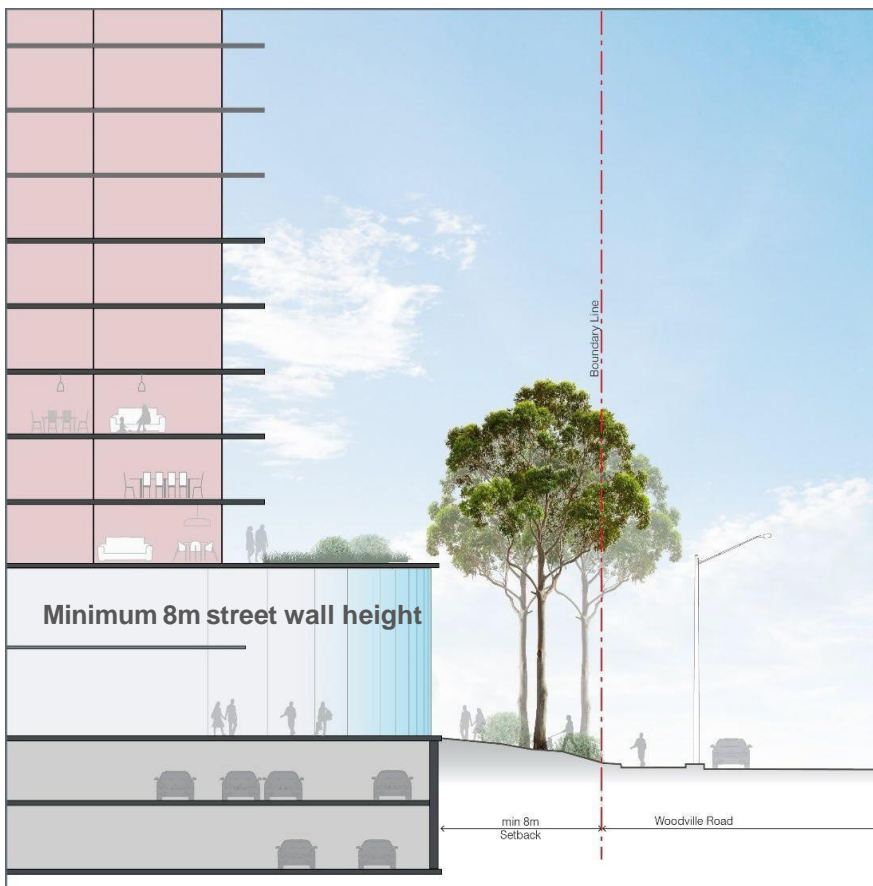

Figure 4: Illustrative section – minimum street wall height for buildings on Woodville Road

### 3.2 Setbacks and building separation

#### Objectives

- O1. Ensure buildings provide adequate setbacks to adjoining properties.
- O2. Provide a cohesive building form that addresses and provides passive surveillance to Crescent Street.
- O3. Provide a sensitive interface along the western boundary with 20 Crescent Street, Holroyd, to allow for existing commercial uses and potential future redevelopment of that site.
- O4. Provide for landscaped setbacks that enhance the site’s setting.
- O5. Ensure development results in a good level of sunlight to communal open spaces, public spaces or neighbouring properties and minimises overlooking.

#### Controls

- C1. Building setbacks should be provided in accordance with Figure 5 and Table 3.

*Table 3 – Building setbacks*

<b>Boundary</b>	<b>Minimum setback to building</b>
Eastern – Woodville Road	21m – deep soil planting (no basement)
Southern – Crescent Street	2m from SP2 zone
Northern – RE1 zone	19m including internal road/circulation
Northern - other	6m
Western – 20 Crescent Street	See control C2

- C2. Adjacent to the western boundary (20 Crescent Street, Holroyd) any proposal should provide:
  - a setback of 5m minimum to the nearest point of the development. At this location the proposal should provide only high-level or translucent windows (apartments will not face the boundary directly).
  - a setback of 30m where apartments will face the western boundary directly.
- C3. All setbacks are to be landscaped to provide a buffer to adjoining residential properties.
- C4. Building separation is to be provided in accordance with Figure 6, to ensure buildings are well- spaced, provide a sense of openness and deliver a high-quality public domain. Buildings are to demonstrate compliance with visual privacy requirements in Part 3 of the Apartment Design Guide.
- C5. A minimum of 2 hours solar access between 9am and 3pm on 21 June, must be provided to private open space areas of surrounding properties.
- C6. All development applications must include solar access diagrams that at a minimum demonstrates compliance with solar access requirements of the Apartment Design Guide and these controls, including plans and elevations or sun-eye views showing the shadows of the proposal at each hour between 9am and 3pm on 21 June.



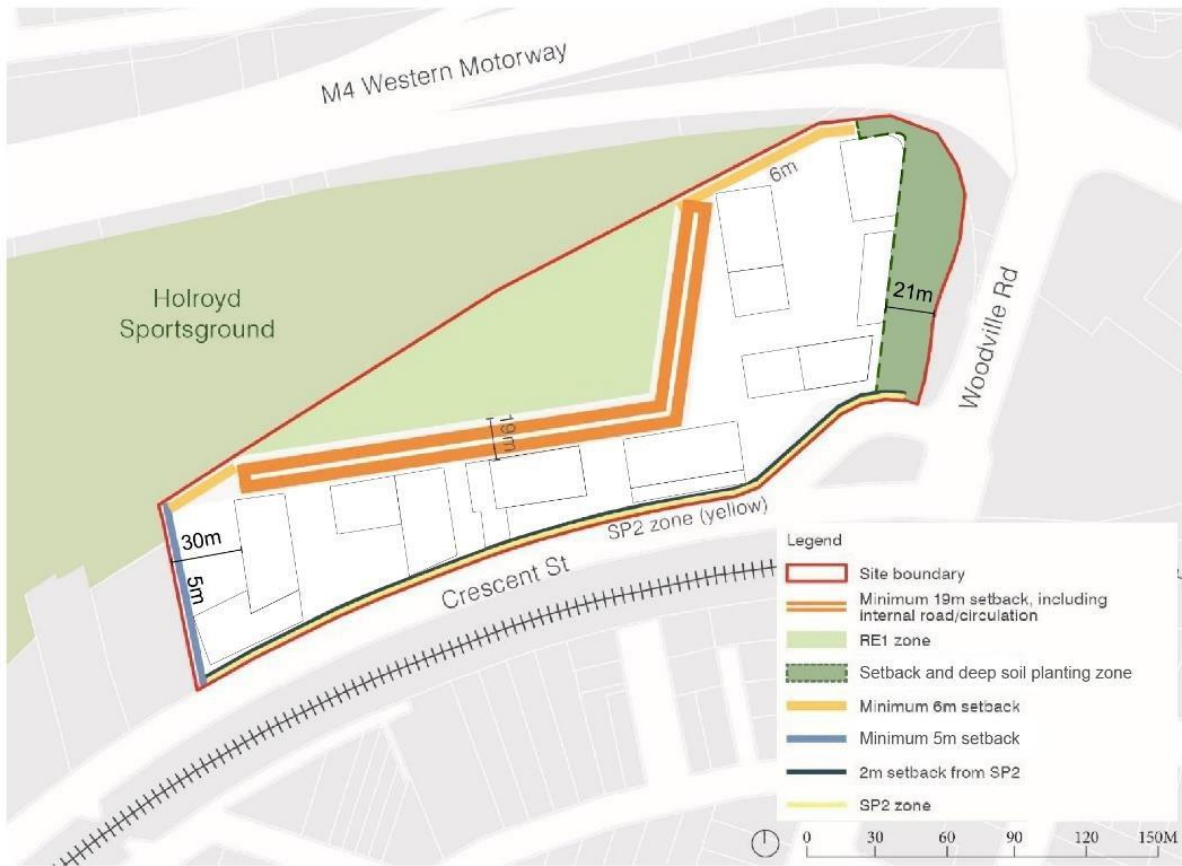

Figure 5: Building setbacks  
(adapted from Architectus Updated Masterplan, dated 3 August 2021)

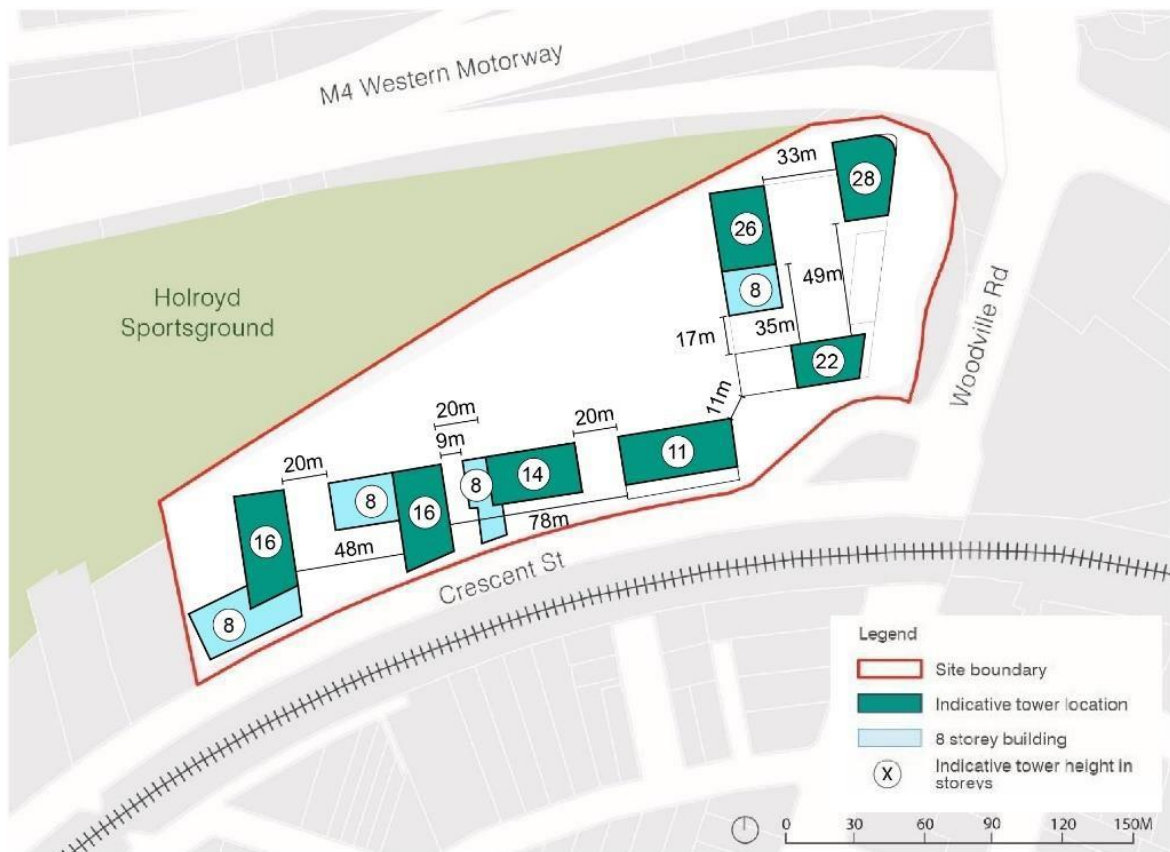

Figure 6: Building separation  
(adapted from Architectus Updated Masterplan, dated 3 August 2021)



### **3.3 Building design**

#### **Objectives**

- O1. Ensure building design responds to the site's urban context.
- O2. Take advantage of the site's northerly aspect and open space views to the north.
- O3. Ensure that adequate cross ventilation and sunlight access is achieved in residential apartments.
- O4. Provide for viable and functional commercial spaces.
- O5. Contribute to activity and surveillance of streets and open spaces and foster a sense of community.

#### **Controls**

- C1. Buildings should be orientated to maximise solar access to apartments and communal open space areas and take advantage of open space views to the north.
- C2. Building design is to minimise visual impacts and overshadowing of open space and adjoining sites to the west, south-west and south.
- C3. Building frontages shall be consistent with Figure 3.
- C4. Buildings should be articulated to manage the appearance of the mass and scale.
- C5. Access to all buildings including lobbies should be clearly visible from internal streets, footpaths and where possible address the street frontage.
- C6. Buildings should be constructed with high quality materials.
- C7. Non-residential uses are encouraged at ground floor, particularly facing the public open space on site.

### **3.4 Noise**

#### **Objectives**

- O1. Minimise impacts of noise from surrounding noise generating land uses, such as busy road and rail.
- O2. Ensure appropriate noise mitigation measures are incorporated into development.
- O3. Achieve an acceptable acoustic environment in habitable rooms, without sealing openings and relying on air conditioning.
- O4. Encourage non-residential ground floor uses to minimise noise impacts on development.

#### **Controls**

- C1. Building design and materials should ensure the development will meet relevant internal noise level criteria, in accordance with the Cumberland DCP 2021, AS/NZ S2107 and other relevant State guidance.
- C2. All development applications should include 3D acoustic modelling to accurately predict the noise impact from nearby roads through building facades.

- C3. Non-residential development is not to adversely affect the amenity of adjacent residential development as a result of noise, hours of operation and/or service deliveries.
- C4. Balconies and other external building elements are to be located, designed and treated to minimise noise infiltration.
- C5. Noise mitigation treatments, such as double glazing, are to be encouraged for the buildings to minimise impacts on residents, workers and visitors.
- C6. Opportunities for flow through ventilation are to be encouraged in buildings where noise mitigation measures are in place, to provide suitable amenity.

### **3.5 Open space**

#### **Objectives**

- O1. Provide open space to meet the needs of future residents and the surrounding Holroyd community.
- O2. Ensure that public open space:
  - is accessible, usable and safe;
  - provides connections to and integrates with Holroyd Sportsground;
  - allows for the retention of significant trees;
  - supports a range of desired activities; and
  - provides an attractive outlook for development.

#### **Controls**

- C1. Open spaces are to be provided generally as shown in Figure 7 including:
  - 7,700sqm of RE1 zoned land, which is to be embellished and dedicated to Council;
  - a central plaza adjacent to the RE1 zone and with direct frontage to buildings and the internal street network; and
  - other setbacks and incidental areas between buildings.
- C2. The open spaces required under C1 are to provide for both active and passive recreation, and include a children's play area, informal sports activities, and picnic facilities for families and small groups to gather.
- C3. Consideration should be given to providing connections and embellishments to the Holroyd Sportsground and improvements to the A'Becketts Creek drainage channel to better integrate the site with the lands to the north, subject to Council approval.
- C4. Communal open space is to be provided for future residents in accordance with the Apartment Design Guide.

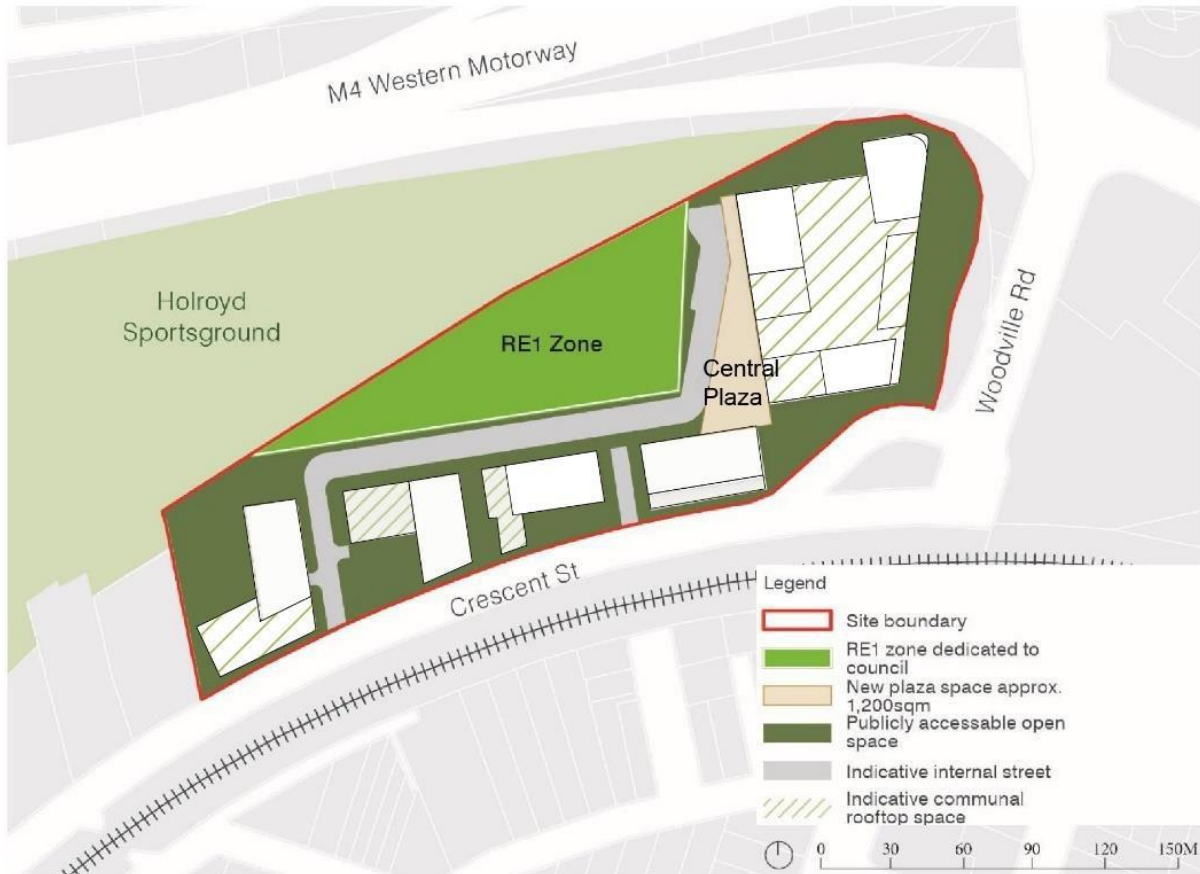

Figure 7: Open Space (adapted from Architectus Updated Masterplan, dated 3 August 2021)

### 3.6 Landscaping and trees

#### Objectives

- O1. Maximise opportunities for landscaping, including the retention of trees and deep soil areas.
- O2. Ensure sufficient space for landscaping that will complement buildings and enhance the landscape character of the site.
- O3. Retain significant trees and native vegetation on the site.
- O4. Ensure that the landscaping of open space areas (public, private and communal) is functional and meets user requirements for privacy, solar access, shade and recreation.

#### Controls

- C1. A minimum 35% of the site area is to be landscaped area. Landscaped area means any part of a site, at ground level, that is permeable and consists of soft landscaping, turf or planted areas and the like, pervious paved areas and includes building setbacks but excludes building footprints, surfaced roads and parking.
- C2. A landscaping strategy is to be submitted as part of the first development application for the site. This strategy shall:
  - be in accordance with Part G7 Tree Management and Landscaping in the Cumberland DCP 2021;

- demonstrate how the site will integrate with the Holroyd Sportsground and A'Becketts Creek, including improvements, softening of the hard edge of the A'Becketts Creek Channel, consideration of views and improved access and connectivity (subject to the relevant authorities agreement); and
  - demonstrate how deep soil planting will support large, spreading canopy trees, with a minimum canopy cover of 15% of the site area.
- C3. Significant trees (identified as Priority for Retention or Consider for Retention) are to be retained where possible.
- C4. A Tree Management Plan is to be submitted with the first development application for the site. The Tree Management Plan is to be prepared by a suitably qualified Australian Qualification Framework Level 5 Arborist and contain the following information:
- Identify all existing trees on the site including species, condition, height and spread;
  - Identify whether trees are to be removed, replanted or retained; and
  - Details of how those trees to be retained will be protected during construction.

### **3.7 Vehicular access and movement**

#### **Objectives**

- O1. Ensure development does not have an adverse impact on surrounding road network operations.
- O2. Ensure that the vehicular access and movement network promotes streetscape quality, amenity and pedestrian safety.
- O3. Provide safe and efficient access to the site.
- O4. Provide improved pedestrian and cyclist connectivity through the site to land to the north.
- O5. Minimise potential for pedestrian and vehicular conflict through best practice design.

#### **Controls**

- C1. The vehicular movement and access network should generally be in accordance with Figure 8, including:
- A primary vehicular entry from Crescent Street immediately east of Building 7, which links to an internal private, but publicly accessible street network adjacent to RE1 zoned land; and
  - Secondary vehicle access from Crescent Street that will be subject to traffic engineering considerations and Transport for NSW advice.

Vehicular entry and exit points are not to be located on motorways and arterial roads adjoining the site.

- C2. The primary internal road is to extend along the length of the RE1 zoned land.
- C3. A traffic management plan is to be submitted as part of the first development application for the site, detailing access and staging arrangements for the redevelopment of the site.
- C4. Internal streets should be designed with high quality hard landscape materials that reinforce a low speed pedestrian focused village environment.

- C5. The first development application shall detail and commit to the provision of road upgrade works along Crescent St, Holroyd, and at the intersection of Crescent St and Woodville Road, Holroyd, to provide additional road and intersection capacity in response to additional traffic generated by the site.
- C6. The first development application shall detail and commit to the provision of intersection upgrade works at the intersection of Pitt St and Walpole St, Merrylands, to provide additional road intersection capacity in response to additional traffic generated by the site.
- C7. The first development application shall detail and commit to the provision of walking and cycling infrastructure upgrade to support continuous connections between the site and Merrylands Station, to provide alternate transport options in response to additional demand generated by the site.

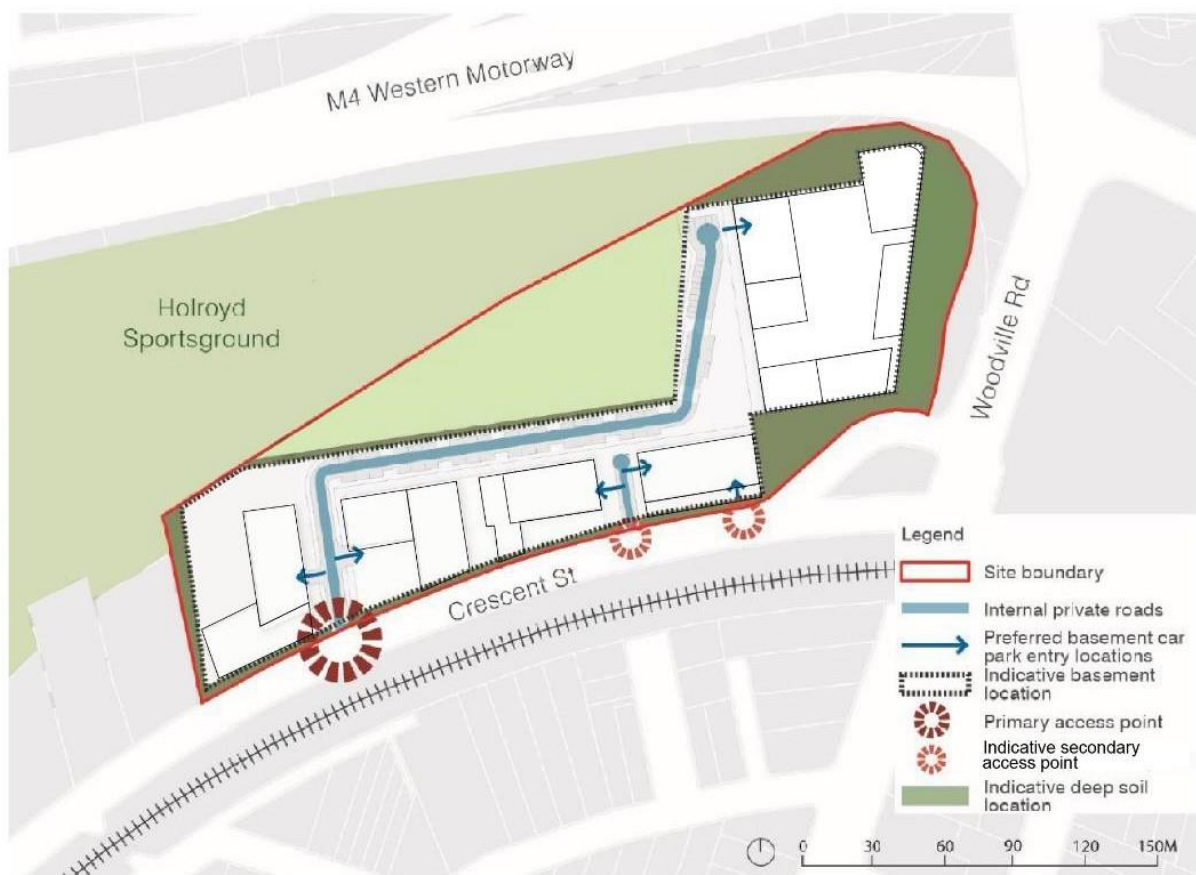

Figure 8: Vehicular access and movement  
 (adapted from Architectus Updated Masterplan, dated 3 August 2021)

### 3.8 Connectivity

#### Objectives

- O1. Improve access and connectivity to public transport.
- O2. Provide for improved pedestrian connectivity through the site to Holroyd Sportsground and Merrylands.
- O3. Connect the site to existing cycle and pedestrian networks to provide convenient access to surrounding centres of Merrylands and Granville.

## Controls

- C1. Pedestrian access along Woodville Road and Crescent Street should be designed to improve the pedestrian experience with landscaped setbacks and street trees to provide shade.
- C2. North-south pedestrian and cycle connections should be provided through the site, connecting the cycle way to the north of Holroyd Sportsground and Crescent Street to the south of the site, generally in accordance with Figure 9.
- C3. Pedestrian and cycle connectivity should be provided to Holroyd Sportsground to the north of the site and towards Merrylands Station to the south of the site.
- C4. The first development application shall detail and commit to improvements for the wider pedestrian and cycle network to improve accessibility and ensure barrier free access to nearby rail stations for future residents and workers.
- C5. The first development application shall outline the arrangements for the provision of a shuttle service operated for the site as an ongoing basis, providing connectivity (at a minimum) between the site and Merrylands.

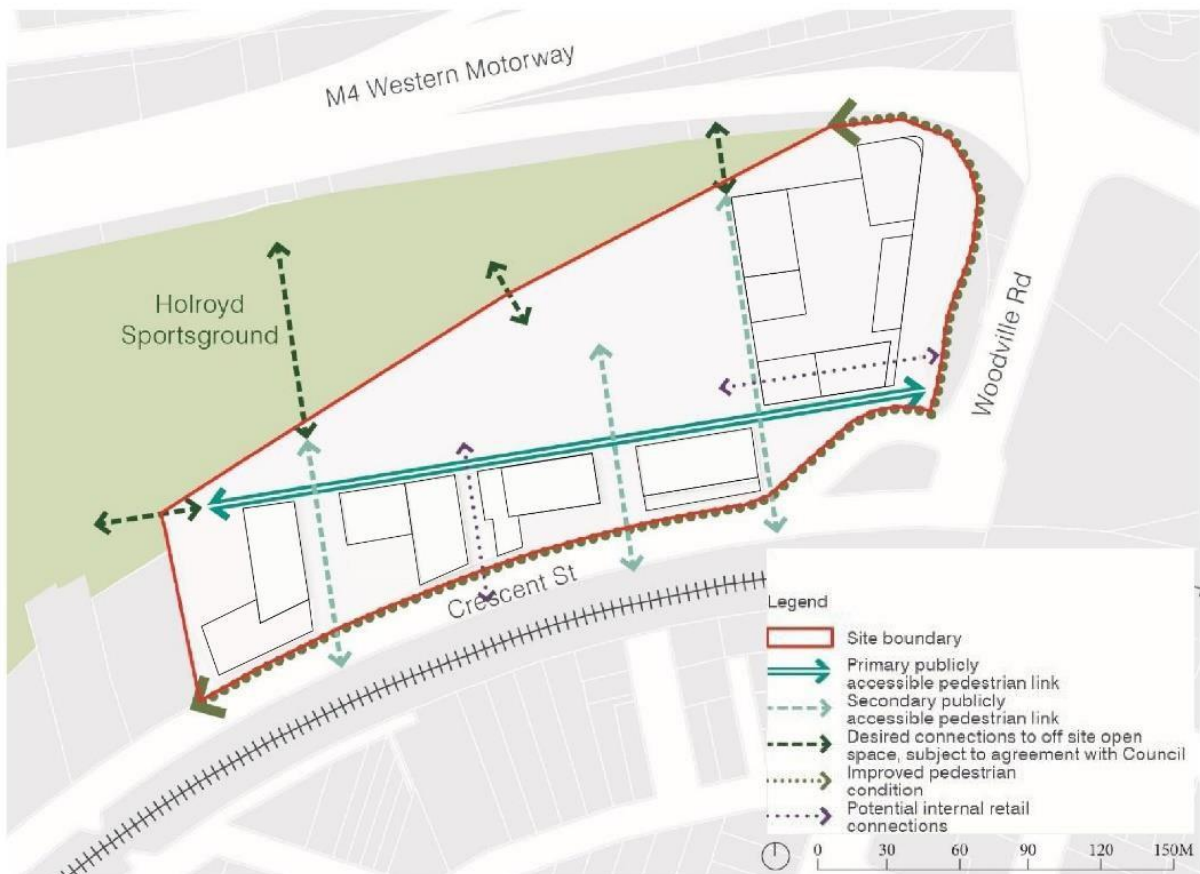

Figure 9: Site connectivity  
(adapted from Architectus Updated Masterplan, dated 3 August 2021)

## 3.9 Parking and basement access

### Objectives

- O1. Provide sufficient parking that is convenient for workers, residents and visitors.



- O2. Ensure that basement entry points and design do not impact on the quality and function of internal streets, public open space areas and communal spaces.
- O3. Ensure basement car parking and access points are integrated with the form and arrangement of buildings on the site.

**Controls**

- C1. Car parking rates shall be consistent with the provisions outlined in the Cumberland LEP 2021 for the site and the Cumberland DCP 2021.
- C2. Basement entry points should generally be in accordance with Figure 10 but are subject to detailed design.
- C3. Basement entries and cross-overs should be designed to minimise impacts on streetscape, amenity, pedestrian safety and circulation.
- C4. All basements shall be interlinked to enable cars and people to travel between buildings whilst minimising impacts on internal streets and on-street parking areas within the site.
- C5. Car parking should be located below ground.
- C6. Accessible car parking spaces for people with mobility impairment are to be included in the allocation of car parking for the development and designed in accordance with the requirements of relevant Australian Standards.

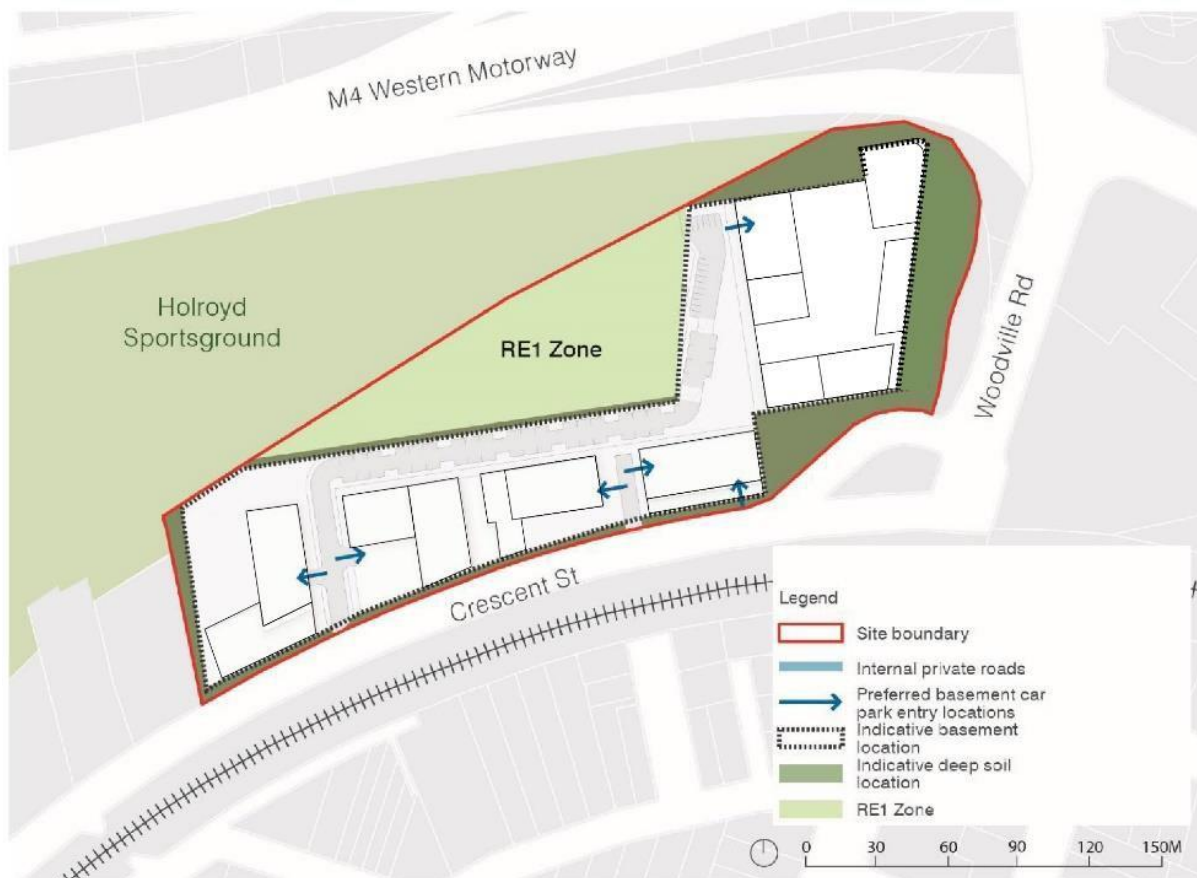

Figure 10: Basement location and entries (indicative)  
 (adapted from Architectus Updated Masterplan, dated 3 August 2021)



### **3.10 Site contamination and remediation**

#### **Objectives**

- O1. Minimise impacts of contamination on future development and open space on the site.
- O2. Ensure appropriate contamination mitigation measures are incorporated into development.

#### **Controls**

- C1. The assessment of contamination as part of the development application shall ensure that the development will deal with any contamination issues in accordance with the Chapter 4 Remediation of Land of State Environment Planning Policy (Resilience and Hazards) 2021, Cumberland DCP 2021 and other relevant State guidance.
- C2. All appropriate reports shall be provided for development applications to demonstrate that contamination issues are able to be adequately addressed for the safety of current and future uses of the site.
- C3. Consideration needs to be given that contamination from A'Becketts Creek can be suitably managed and will not impact on current and future users of the site.
- C4. Should any land on the site be transferred to Council in the future, the landowner or their representative must demonstrate to Council's satisfaction that contamination and remediation are suitably managed and/or addressed on the relevant land.

### **3.11 A'Becketts Creek drainage channel**

#### **Objectives**

- O1. Minimise impacts of the development on the drainage channel and surrounding land.
- O2. Ensure appropriate mitigation measures are incorporated into development to ensure the safe and effective function of the drainage channel and surrounding land.

#### **Controls**

- C1. The assessment of the A'Becketts Creek drainage channel as part of the development application shall ensure that the development will deal with any issues in accordance with the Cumberland DCP 2021 and other relevant guidance.
- C2. All appropriate reports shall be provided for development applications to demonstrate that works, buildings and/or structures adjoining, crossing or in close proximity of the drainage channel and surrounding land are able to ensure the continued structural integrity and enhanced environmental outcomes of the drainage channel for the safety and benefit of current and future users of the site.

### **3.12 Railway Memorial**

#### **Objectives**

- O1. Avoid impacts of the development on the Railway Memorial.

**Controls**

- C1. The Railway Memorial, located at the corner of The Crescent and Woodville Road, Holroyd, is a heritage item in the Cumberland LEP 2021 (I121). Given its significance in representing the evolution of transport in Sydney, all development applications must demonstrate that the development does not overshadow the heritage item in any way.